

Architectural Door Accessories

ASSA ABLOY
Opening Solutions

Experience a safer
and more open world

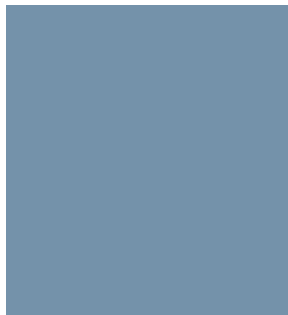
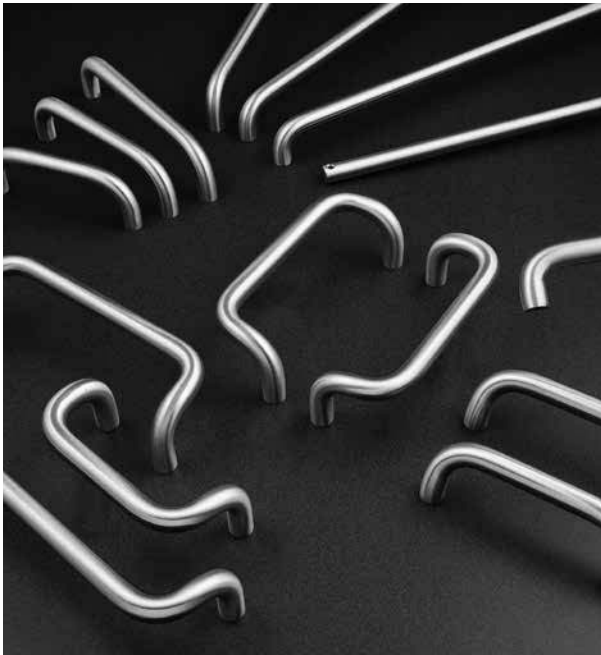
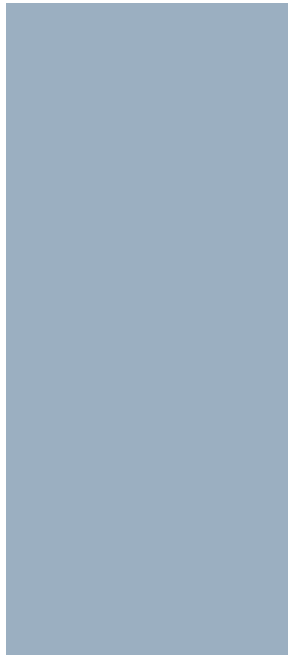
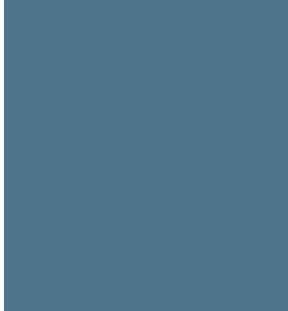

Rockwood Products
Catalog – Accessories

Table of Contents

Page #

General Information	1-10
Section A — Push and Pull Bars	A1-A21
Push and Pull Bar Mounting Details	A1
Push Bars	A2-A3
Pull Bars	A4
Push and Pull Bar Sets	A5-A9
Series 47 Push and Pull Bar Mounting Details	A10
Series 47 Solid & Tubular Push Bars	A11-A12
Series 47 Solid Straight/Offset Push & Pull Bar Sets	A13-A18
Series 47 Tubular Straight/Offset Push & Pull Bar Sets	A19-A21
Section B — Push and Pull Plates, Door Pulls	B1-B35
Push Plate Order Information	B1
Push Plates	B2-B7
Flush Pulls	B8-B12
Straight Door Pulls Mounting Details	B13
Straight Door Pulls	B14-B22, B35
Pull Plates	B23-B26
Offset Door Pulls Mounting Details	B27
Offset Door Pulls	B28-B32
Door Pulls	B33
Hands Free Pulls	B34-B35
Vandal Resistant Trim	B36-B37
Vandal Resistant Pull	B38
Section C — Door Plates, Door Edges & Protectors	C1-C26
Door Plates	C1-C6
Angle Plates	C7
Door Edges (Mortise, Non-Mortise, Overlapping)	C8-C9, C12
Door Edge Order Forms & Worksheets	C10- C15
Trim Protector Bars	C16- C20
Vertical Rod Covers	C21
Custom Strikes	C22-C23
Corner Guards	C24
Latch Protectors	C25-C26
Section D — Stops	D1-D24
Wall Stops	D1-D3
Dome Stops	D4-D5
Roller Stops	D6
Door Stops	D7-D19
Automatic Door Stops	D16-D17
Heavy Duty Door Stops	D9-D10
Overhead Holders & Stops	D20-D24
Section E — Bolts and Latches	E1-E20
Flush Bolts	E1-E4
Strikes & Coordinators	E4
Surface Bolts	E5
Roller Latches	E6-E7
Gate Latch & Door Guards	E8
Door Guards & Silencers	E9
Surface & Flush Bolts	E10
Door Coordinators	E11- E12
Automatic & Combination Flush Bolts	E13- E15
Bottom Fire Bolts	E16
Automatic Flush Bolts	E17
Self Latching Flush Bolts	E18
Pivots	E19- E20
Section F — Auxiliary Hardware	F1-F18
Door Knockers & Viewers	F1-F2
Door Signs	F2-F6
Hand Rail Brackets	F7
Coat Hooks	F8
Pulls, Flush Pulls, Edge & Pocket Pulls	F9-F11
Magnetic Catches, Ball Catches	F12-F13
Filler Plates & Shims	F14-F18

ASSA ABLOY
Opening Solutions

Experience a safer
and more open world

800-458-2424 | www.assaabloydooraccessories.us

Check the web site for the up-to-date catalog

Copyright © 2012-2020, ASSA ABLOY Accessories and Door Controls Group, Inc. All rights reserved. Reproduction in whole or in part without the express written permission of ASSA ABLOY Accessories and Door Controls Group, Inc. is prohibited.

No.	Description	Page	No.	Description	Page
10-PB	Push Bar.....	A2	94P x 94L	Flush Pull Set.....	B10
11-PB	Push Bar.....	A2	95A	Flush Pull.....	B11
12-PB	Push Bar.....	A2	95B	Flush Pull.....	B11
14-PB	Push Bar.....	A3	95R	Flush Pull - Round.....	B11
15-PB	Push Bar.....	A3	96	Flush Pull.....	B12
18-PB	Push Bar.....	A3	102-RKW	Straight Door Pull.....	B14
18BFB	Bottom Fire Bolt - Metal Door.....	E16	102 x 70	Pull Plate.....	B23
19-PB	Push Bar.....	A3	105	Straight Door Pull.....	B14
19BFB	Bottom Fire Bolt - Wood Door.....	E16	105 x 70	Pull Plate.....	B23
20-PB	Pull Bar.....	A4	106-RKW	Straight Door Pull.....	B14
21-PB	Pull Bar.....	A4	106 x 70	Pull Plate.....	B23
22-PB	Pull Bar.....	A4	107	Straight Door Pull.....	B14
23-PB	Pull Bar.....	A4	107 x 70	Pull Plate.....	B23
25-PB	Push Bar.....	A5	108	Straight Door Pull.....	B14
26-PB	Push Bar.....	A5	109	Straight Door Pull.....	B14
27-PB	Push Pull Bar Set.....	A5	110-RKW	Straight Door Pull.....	B14
28-PB	Push Pull Bar Set.....	A5	110 x 70	Pull Plate.....	B23
29-PB	Push Pull Bar Set.....	A5	110-6SP	Security Door Pull.....	B16
30-PB	Push Pull Bar Set.....	A5	111	Straight Door Pull.....	B14
31-PB	Pull Bar.....	A6	111 x 70	Pull Plate.....	B23
32-PB	Pull Bar.....	A6	111A	Straight Door Pull.....	B14
33-PB	Push Bar.....	A6	112	Straight Door Pull.....	B14
34-PB	Push Bar.....	A6	118	Straight Door Pull.....	B14
35-PB	Push Pull Bar Set.....	A6	120	Door Pull.....	B18
36-PB	Push Pull Bar Set.....	A6	121	Door Pull.....	B18
40-PB	Screen Door Guard.....	A7	122-RKW	Door Pull.....	B18
41-PB	Screen Door Guard.....	A7	122 x 70	Pull Plate.....	B24
42-PB	Screen Door Guard.....	A7	123	Door Pull.....	B18
43-PB	Push Bar.....	A8	123 x 70	Pull Plate.....	B24
44-PB	Push Bar.....	A8	125-RKW	Door Pull.....	B19
45-PB	Push Bar.....	A8	125 x 70	Pull Plate.....	B24
47 Series	Series 47 Push Bar.....	A11	126-RKW	Door Pull.....	B19
48-PB	Series 47 Push Bar.....	A11	126 x 70	Pull Plate.....	B24
50-PB	Pull Bar.....	A9	130-RKW	Cast Door Pull.....	B19
51-PB	Push Bar.....	A9	131-RKW	Cast Door Pull.....	B19
52-PB	Push Pull Bar Set.....	A9	132-RKW	Cast Door Pull.....	B20
53-PB	Door Pull.....	A9	132 x 70	Pull Plate.....	B25
70 Series	Push Plate - .050".....	B2	134-RKW	Cast Door Pull.....	B20
71 Series	Push Plate - .062".....	B3	137	Cast Door Pull.....	B21
73 Series	Push Plate - .125".....	B4	137 x 70	Pull Plate.....	B25
73BL	Concealed Mount Push Plate.....	B16	137L	Cast Door Pull.....	B21
73CL	Concealed Mount Push Plate.....	B16	138	Cast Door Pull.....	B21
75 Series	Push Plate - .125".....	B5	139	Cast Door Pull.....	B21
76 Series	Decorative Push Plate - .050".....	B6	147	Door Pull.....	B22
77 Series	Decorative Push Plate - .050".....	B6	147 x 76	Pull Plate.....	B26
80	Push Plate - .050".....	B6	147 x 77	Pull Plate.....	B26
81	Push Plate - .050".....	B6	147L	Door Pull.....	B22
82	Push Plate - .050".....	B6	148	Door Pull.....	B22
84	Push Plate - .050".....	B6	148 x 76	Pull Plate.....	B26
85	Push Plate - .050".....	B7	148 x 77	Pull Plate.....	B26
86	Push Plate - .050".....	B7	149	Door Pull.....	B22
87	Push Plate - .125".....	B7	176-RKW	Offset Door Pull.....	B32
90	Cylinder Pull.....	B8	177	Offset Door Pull.....	B32
90B	Cylinder Pull.....	B8	185	Offset Door Pull.....	B32
91-RKW	Combination Push Pull Plate.....	B8	193	Hand/Arm Pull.....	B34
92-RKW	Combination Push Pull Plate.....	B8	208	Wooden Door Pull.....	B33
93-RKW	Combination Push Pull Plate.....	B8	215	Tapered Door Pull.....	B33
94	Flush Pull.....	B9	215L	Tapered Door Pull.....	B33
94BTB	Flush Pull.....	B9	290	Corner Guard.....	C24
94C	Flush Pull.....	B9	291	Corner Guard.....	C24
94DLL	Dead Lock Flush Pull.....	B9	295	Corner Guard.....	C24
94DLS	Dead Lock Flush Pull.....	B9	296	Corner Guard.....	C24
94L	Flush Pull.....	B10	300	Mortise Door Edge.....	C8
94P	Flush Pull.....	B10			

No.	Description	Page	No.	Description	Page
301	Mortise Door Edge.....	C8	468-RKW	Heavy Duty Door Stop	D10
302	Mortise Door Edge.....	C8	470	Door Stop	D11
302B	Mortise Door Edge.....	C8	471	Door Stop	D11
304	Non-Mortise Door Edge	C9	472	Door Stop w/Keeper	D11
305	Non-Mortise Door Edge	C9	473	Door Stop w/Keeper	D11
306-RKW	Non-Mortise Door Edge	C9	474	Door Stop	D12
306-AST	Non-Mortise Door Edge	C9	475	Door Stop	D12
306B	Non-Mortise Door Edge	C9	476	Door Stop w/Keeper	D12
306B-AST	Non-Mortise Door Edge	C9	477	Door Stop w/Keeper	D12
307	Non-Mortise Door Edge	C9	481	Door Stop	D13
308	Overlapping Door Edge	C12	481H	Door Stop	D13
309	Overlapping Door Edge	C12	481MP	Door Stop	D13
310	Overlapping Door Edge	C12	482	Door Stop	D14
310B	Overlapping Door Edge	C12	483	Door Stop	D14
310BS	Overlapping Door Edge	C12	485	Door Stop w/Keeper	D14
310S	Overlapping Door Edge	C12	486	Angle Door Stop.....	D15
320-RKW	Latch Protector	C25	487	Heavy Duty Wall Stop.....	D15
320C	Latch Protector	C25	488	Door Stop	D15
320CL	Latch Protector	C25	489	Door Stop	D15
320CXL	Latch Protector	C25	490	Door Holder & Stop.....	D16
321	Latch Protector	C25	491-RKW	Automatic Door Holder & Stop.....	D16
322	Latch Protector	C26	491R	Automatic Door Holder & Stop.....	D16
325	Latch Protector	C26	491S	Automatic Door Holder & Stop.....	D16
330	Latch Protector	C26	494-RKW	Automatic Door Holder & Stop/Foot Pull.....	B35, D17
400	Solid Cast Wall Stop.....	D1	494R	Automatic Door Holder & Stop.....	D17
401	Solid Cast Wall Stop.....	D1	494S	Automatic Door Holder & Stop.....	D17
402	Solid Cast Wall Stop.....	D1	505-RKW	Door Stop	D18
403	Solid Cast Wall Stop.....	D1	508	Door Stop	D18
404	Solid Cast Wall Stop.....	D1	517	Aluminum Door Stop.....	D18
405	Solid Cast Wall Stop.....	D1	518	Door Stop	D18
406	Wrought Wall Stop	D1	519	Door Stop	D18
409	Wrought Wall Stop	D1	520	Replacement Bumper	D18
412	Solid Cast Wall Stop.....	D2	525	Spring Base Door Stop	D19
415	Solid Cast Wall Stop.....	D2	526	Spring Base Door Stop	D19
416	Solid Cast Wall Stop.....	D2	528	Hinge Pin Stop	D19
426	Wall Stop.....	D3	550	Lever Extension Flush Bolt	E1
430-RKW	Solid Cast Wall Stop.....	D3	554	Rabbet Piece	E1
431-RKW	Wall Stop.....	D3	554G	Rabbet Guide.....	E1
432W	Wall Stop.....	D3	554S	Rabbet Guide.....	E1
440	Low Dome Stop.....	D4	555	Lever Extension Flush Bolt	E2
441	Low Dome Stop.....	D4	555 x 18BFB	Lever Extension Flush Bolt	E2
441CU	Dome Stop Combination Unit.....	D4	556WS	Lever Extension Flush Bolt	E3
441H	Cast Universal Dome Stop	D5	557	Lever Extension Flush Bolt	E3
442	High Dome Stop.....	D5	557 x 19BFB	Lever Extension Flush Bolt	E4
443	High Dome Stop.....	D5	570	Dust Proof Strike	E4
444	Cast Door Stop Riser.....	D5	576	Gravity Door Coordinator.....	E4
445	Heavy Duty Door Stop	D5	580 Series	Surface Bolts	E5
445H	Heavy Duty Door Stop	D5	582 Series	Surface Bolts	E5
446	Door Stop	D6	585 Series	Heavy Duty Surface Bolts.....	E5
449	Door Stop Riser	D6	590	Roller Latch w/Cast Strike	E6
455	Curved Roller Stop	D6	590DA	Roller Latch w/Double Acting Strike.....	E6
456-RKW	Straight Roller Stop.....	D6	591	Roller Latch w/ASA Strike.....	E6
456L	Straight Roller Stop.....	D7	592	Roller Latch w/#161 Strike	E7
458	Kick Down Door Stop.....	D7	593	Roller Latch w/Angle Strike	E7
459	Spring Loaded Plunger Stop	D7	594	Roller Latch w/161 Strike.....	E7
460	Kick Down Door Stop.....	D7	602	Secret Gate Latch.....	E8
461	Kick Down Door Stop.....	D8	603	Door Guard w/Shim	E8
461L	Kick Down Door Stop.....	D8	604	Door Guard w/Shim	E8
462	Heavy Duty Door Stop	D9	605	Door Guard Protection Plate	E8
463-RKW	Heavy Duty Door Stop	D9	605SMS	Door Guard Protection Plate	E8
464-RKW	Heavy Duty Door Stop w/Holder	D9	606-RKW	Door Guard Protection Plate	E9
465	Heavy Duty Door Stop	D9	608-RKW	Door Silencer.....	E9
466-RKW	Heavy Duty Door Stop	D10	608CA	Door Silencer.....	E9
467-RKW	Heavy Duty Door Stop	D10	609	Door Silencer.....	E9
			611	Door Knocker	F1
			614	Door Knocker	F1

ASSA ABLOY
Opening Solutions

Experience a safer
and more open world

800-458-2424 | www.assaabloydooraccessories.us
Check the web site for the up-to-date catalog

Copyright © 2012-2020, ASSA ABLOY Accessories and Door Controls Group, Inc. All rights reserved. Reproduction in whole or in part without the express written permission of ASSA ABLOY Accessories and Door Controls Group, Inc. is prohibited.

No.	Description	Page	No.	Description	Page
614V	Door Knocker w/Viewer	F1	2945	Combination Flush Bolt Set	E14
619	160° Door Viewer.....	F1	2948	Automatic Flush Bolt Set.....	E15
620	160° Door Viewer.....	F1	2949	Self Latching Flush Bolt (w/bottom fire bolt).....	E18
620VC	160° Door Viewer.....	F1	2960	Automatic Flush Bolt (w/bottom fire bolt).....	E17
621	160° Door Viewer.....	F1	2962	Automatic Flush Bolt Set.....	E17
622	190° Door Viewer.....	F2	11047	Straight Push Pull Bar Set.....	A13
622VC	190° Door Viewer	F2	11047-2	Straight Push Pull Bar Set.....	A14
624	160° Door Viewer.....	F1	11047-3	Straight Push Pull Bar Set.....	A15
626	190° Door Viewer.....	F2	111A47	Straight Push Pull Bar Set.....	A13
627	190° Door Viewer w/Heavy Duty Cover	F2	111A47-2	Straight Push Pull Bar Set.....	A14
628	190° Door Viewer w/Heavy Duty Cover	F2	111A47-3	Straight Push Pull Bar Set.....	A15
629	190° Door Viewer w/Heavy Duty Cover	F2	11147	Straight Push Pull Bar Set.....	A13
618W	Door Viewer Washer	F2	11147-2	Straight Push Pull Bar Set.....	A14
630 Series	Surface Bolts	E10	11147-3	Straight Push Pull Bar Set.....	A15
640	Residential Flush Bolt	E10	11247	Straight Push Pull Bar Set.....	A13
640RE	Residential Flush Bolt.....	E10	11247-2	Straight Push Pull Bar Set.....	A14
651	Card Holder.....	F2	11247-3	Straight Push Pull Bar Set.....	A15
660	Decal.....	F3	11847	Straight Push Pull Bar Set.....	A13
661	Decal.....	F3	AP1007	Arm Pull	B34
662-RKW	Decal.....	F3	AP1140	Arm Pull	B34
670	Engraved Sign - SPECIFY COPY	F3	AP1141	Arm Pull	B34
670M	Engraved Sign - MEN	F3	BF97	Barrier Free Flush Pull	B12
670R	Engraved Sign - RESTROOM.....	F3	BF97L	Barrier Free Flush Pull	B12
670W	Engraved Sign - WOMEN	F3	BF150	90° Offset Door Pull.....	B28
674H	Engraved Sign - PUSH.....	F3	BF151	90° Offset Door Pull.....	B28
674L	Engraved Sign - PULL.....	F3	BF152	90° Offset Door Pull.....	B28
700	Hand Rail Bracket.....	F7	BF156	90° Offset Door Pull.....	B28
701	Hand Rail Bracket.....	F7	BF15647	Offset Push Pull Bar Set.....	A16
702	Hand Rail Bracket.....	F7	BF15647-2	Offset Push Pull Bar Set.....	A17
790	Small Coat Hook.....	F8	BF15647-3	Offset Push Pull Bar Set.....	A18
796	Small Double Coat Hook.....	F8	BF157	90° Offset Door Pull.....	B28
802	Medium Coat Hook.....	F8	BF157A	90° Offset Door Pull.....	B28
806	Medium Coat Hook.....	F8	BF157A47	Offset Push Pull Bar Set.....	A16
841	Ball Knob	F9	BF157A47-2	Offset Push Pull Bar Set.....	A17
845	Utility Pull	F9	BF157A47-3	Offset Push Pull Bar Set.....	A18
850	Solid Wire Pull.....	F9	BF15747	Offset Push Pull Bar Set.....	A16
851	Solid Wire Pull.....	F9	BF15747-2	Offset Push Pull Bar Set.....	A17
852	Solid Wire Pull.....	F9	BF15747-3	Offset Push Pull Bar Set.....	A18
853	Solid Wire Pull.....	F9	BF158	90° Offset Door Pull.....	B28
856-RKW	Heavy Wire Pull.....	F9	BF15847	Offset Push Pull Bar Set.....	A16
860	Flush Cup Pull	F10	BF15847-2	Offset Push Pull Bar Set.....	A17
870	Wrought Flush Pull.....	F10	BF15847-3	Offset Push Pull Bar Set.....	A18
872	Cast Flush Pull.....	F10	BF159	90° Offset Door Pull.....	B28
880	Cast Lever Edge Pull	F11	BF15947	Offset Push Pull Bar Set.....	A16
885-RKW	Concealed Edge Pull.....	F11	BF160	45° Offset Door Pull.....	B31
890	Pocket Door Pull.....	F11	BF161	45° Offset Door Pull.....	B31
891	Pocket Door Privacy Latch	F11	BF162	45° Offset Door Pull.....	B31
900	Magnetic Catch.....	F12	BF166	45° Offset Door Pull.....	B31
901	Magnetic Catch.....	F12	BF167	45° Offset Door Pull.....	B31
910	Adjustable Ball Catch.....	F13	BF167A	45° Offset Door Pull.....	B31
910RC	Adjustable Ball Catch.....	F13	BF168	45° Offset Door Pull.....	B31
911	Adjustable Ball Catch.....	F13	BF169	45° Offset Door Pull.....	B31
911RC	Adjustable Ball Catch.....	F13	BF257	Heavy Duty Offset Door Pull	B36
1100	Carry Bar	E12	BF258	Heavy Duty Offset Door Pull	B36
1700	Door Coordinator	E12	BF259	Heavy Duty Offset Door Pull	B36
2600	Series Door Coordinators	E11	BF260	Heavy Duty Offset Door Pull	B36
2601AB	Mounting Brackets	E12	BF680	Engraved Sign w/Braille - SPECIFY COPY.....	F4
2601C	Mounting Brackets	E12	BF680M	Engraved Sign w/Braille - MEN	F4
2805	Combination Flush Bolt.....	E13	BF680R	Engraved Sign w/Braille - RESTROOM.....	F4
2840	Automatic Flush Bolt.....	E13	BF680W	Engraved Sign w/Braille - WOMEN.....	F4
2842	Automatic Flush Bolt Set.....	E13	BF683	Tactile ADA Sign w/Braille.....	F5
2845	Combination Flush Bolt Set	E13	BF684	Tactile ADA Sign w/Braille.....	F5
2848	Automatic Flush Bolt Set.....	E15	BF685	Tactile ADA Sign w/Braille.....	F5
2849	Self Latching Flush Bolt (w/bottom fire bolt).....	E18			
2905	Combination Flush Bolt.....	E14			
2940	Automatic Flush Bolt	E14			
2942	Automatic Flush Bolt Set.....	E14			

800-458-2424 | www.assaabloydooraccessories.us

Check the web site for the up-to-date catalog

Copyright © 2012-2020, ASSA ABLOY Accessories and Door Controls Group, Inc. All rights reserved. Reproduction in whole or in part without the express written permission of ASSA ABLOY Accessories and Door Controls Group, Inc. is prohibited.

ASSA ABLOY
Opening Solutions

Experience a safer
and more open world

No.	Description	Page	No.	Description	Page
BF686	Tactile ADA Sign w/Braille.....	F5	K3125	Laminate Plastic Door Plate - .125"	C6
BF687	Tactile ADA Sign w/Braille.....	F5	K4125	Clear Plastic Door Plate - .125".....	C6
BF688	Tactile ADA Sign w/Braille.....	F5	KB1150	Angle Plate - .050".....	C7
BF689	Tactile ADA Sign w/Braille.....	F5	KB1151	Angle Plate - .050".....	C7
BFLG10	Latch Guard Cover.....	C21	KB1152	Angle Plate - .050".....	C7
BFLG12	Latch Guard Cover.....	C21	LA86	Latch Adapter Plate.....	F17
BFLG16	Latch Guard Cover.....	C21	LF161	Door Edge Filler Plate	F18
BFLG1050	Vertical Rod Latch Guard Cover.....	C21	OH100 Series	Concealed Overhead Holder & Stop	D20
BFM624	All Gender Restroom Sign	F6	OH200 Series	Surface Overhead Holder & Stop.....	D22
BFM625	All Gender Restroom Sign	F6	OH900 Series	Surface Overhead Holder & Stop.....	D23
BFM682	Tactile ADA Molded Plastic Sign w/Braille.....	F6	OH1000 Series	Surface Overhead Holder & Stop.....	D24
BFM684	Tactile ADA Molded Plastic Sign w/Braille.....	F6	PDL - PDLAA	Privacy Door Latch.....	E9
BFM685	Tactile ADA Molded Plastic Sign w/Braille.....	F6	R101LPB	Trim Protector Bar.....	C19
BFM686	Tactile ADA Molded Plastic Sign w/Braille.....	F6	R102LPB	Trim Protector Bar.....	C19
BFM687	Tactile ADA Molded Plastic Sign w/Braille.....	F6	R111LPB	Trim Protector Bar.....	C19
BFM688	Tactile ADA Molded Plastic Sign w/Braille.....	F6	R112LPB	Trim Protector Bar.....	C19
BFM689	Tactile ADA Molded Plastic Sign w/Braille.....	F6	R115LPB	Trim Protector Bar.....	C19
BFRC12	Vertical Rod Cover.....	C21	R116EDPH	Exit Device Protector	C20
BFRC24	Vertical Rod Cover.....	C21	R116EDPL	Exit Device Protector	C20
BP47 Series	Series 47 Push Bar w/Base Plate	A12	SD1230	Standard Duty Trim Protector Bar.....	C18
BP47-2	Series 47 Push Bar w/Base Plate	A12	SD1240	Standard Duty Trim Protector Bar.....	C18
BP47-3	Series 47 Push Bar w/Base Plate	A12	SD1250	Standard Duty Trim Protector Bar.....	C18
CP10 Series	Standard Head Pivot.....	E19	SD1260	Standard Duty Trim Protector Bar.....	C18
CP40 Series	Standard Floor Pivot	E19	SF160	Strike Filler Plate.....	F18
CPK1840	Cover Plate Kit.....	E16	SFASA	Strike Filler Plate.....	F18
CS Series	Custom Strikes.....	C22	SFB160	Strike Filler Plate.....	F18
D89	Security Flush Pull.....	B8	SP47	Series 47 Push Bar.....	A11
D133-RKW	Security Loop Door Pull.....	B20	T47 Series	Tubular Push Bars.....	A19
DF86	Door Edge Filler Plate	F14	T110 - T112	Tubular Straight Door Pulls.....	B15
DFF4	Frame Hinge Filler Plate.....	F14	T118	Tubular Straight Door Pulls.....	B15
DFF5	Frame Hinge Filler Plate.....	F14	T11047	Straight Tubular Single Bar Sets	A20
DHF4B	Beveled Door Hinge Filler Plate.....	F14	T111A47	Straight Tubular Single Bar Sets	A20
DHF4S	Square Door Hinge Filler Plate.....	F15	T11147	Straight Tubular Single Bar Sets	A20
DHF5B	Beveled Door Hinge Filler Plate.....	F15	T11247	Straight Tubular Single Bar Sets	A20
DHF5S	Square Door Hinge Filler Plate.....	F15	T11847	Straight Tubular Single Bar Sets	A20
FB-1	Filler Bar.....	E12	TBF156	Tubular 90° Offset Door Pulls	B29
FB-2	Filler Bar.....	E12	TBF157	Tubular 90° Offset Door Pulls	B29
FBF48	Flush Bolt Filler Plate.....	F15	TBF157A	Tubular 90° Offset Door Pulls	B29
FBS48	Flush Bolt Strike Filler Plate	F16	TBF158	Tubular 90° Offset Door Pulls	B29
FC161	Door Face Filler Plate	F16	TBF159	Tubular 90° Offset Door Pulls	B29
FD160	Door Face Filler Plate.....	F16	TBF15647	Offset Tubular Single Bar Sets.....	A21
FP1230	Foot Pull.....	B35	TBF157A47	Offset Tubular Single Bar Sets.....	A21
HD2230	Heavy Duty Trim Protector Bar.....	C17	TBF15747	Offset Tubular Single Bar Sets.....	A21
HD2230M	Heavy Duty Trim Protector Bar.....	C17	TBF15847	Offset Tubular Single Bar Sets.....	A21
HD2240	Heavy Duty Trim Protector Bar.....	C17	TBF15947	Offset Tubular Single Bar Sets.....	A21
HD2240M	Heavy Duty Trim Protector Bar.....	C17	VRT12	Vandal Resistant Trim	B36
HD2250	Heavy Duty Trim Protector Bar.....	C17	VRT14	Vandal Resistant Trim	B37
HD2250M	Heavy Duty Trim Protector Bar.....	C17	VRT16	Vandal Resistant Trim	B37
HG70C	Horizontal Grain Push Plate - .050"	B2	VRT22	Vandal Resistant Trim	B36
HS42	4 1/2" Hinge Shim - .028"	F16	VRT24	Vandal Resistant Trim	B37
HS44	4 1/2" Hinge Shim - .065"	F17	VRT26	Vandal Resistant Trim	B37
HS52	5" Hinge Shim - .028"	F17	VRP30	Vandal Resistant Pull	B38
HS54	5" Hinge Shim - .065"	F17	Y105 - Y112	Door Pull w/Base Plate	B17
K1038	Metal Door Plate - .038"	C1	Y118	Door Pull w/Base Plate	B17
K1050	Metal Door Plate - .050" (Quick Ship)	C1	YBF150	90° Offset Door Pull w/Base Plate.....	B30
K1050-1-K1050-8	Shaped Door Plates - .050"	C2	YBF151	90° Offset Door Pull w/Base Plate.....	B30
K1050A-1-K1050A-8	Shaped Door Plates - .050"	C3	YBF152	90° Offset Door Pull w/Base Plate.....	B30
K1050F	Metal Door Plate - .050"	C1	YBF156	90° Offset Door Pull w/Base Plate.....	B30
K1062	Metal Door Plate - .062"	C4	YBF157A	90° Offset Door Pull w/Base Plate.....	B30
K1125	Metal Door Plate - .125"	C4	YBF157	90° Offset Door Pull w/Base Plate.....	B30
K2060	Plastic Door Plate - .060"	C5	YBF158	90° Offset Door Pull w/Base Plate.....	B30
K2125	Plastic Door Plate - .125"	C5	YBF159	90° Offset Door Pull w/Base Plate.....	B30

ASSA ABLOY
Opening Solutions

Experience a safer
and more open world

800-458-2424 | www.assaabloydooraccessories.us

Check the web site for the up-to-date catalog

Copyright © 2012-2020, ASSA ABLOY Accessories and Door Controls Group, Inc. All rights reserved. Reproduction in whole or in part without the express written permission of ASSA ABLOY Accessories and Door Controls Group, Inc. is prohibited.



Rockwood Manufacturing Co. founders, brothers Norman and Vernon Gurzenda

About Rockwood Manufacturing Company

Rockwood Manufacturing Company, founded in 1946 by the Gurzenda Family in rural southwestern Pennsylvania, focuses on the design and manufacture of quality builders' hardware for commercial, institutional and finer residential buildings. Now in the third generation of skilled craftsman, we continue to develop new products and processes that improve our offering. Strict attention to detail from the selection of top-grade materials to the application of the finest finishes results in a tough, yet handsome product of the highest caliber.

In 2008 Rockwood Manufacturing Company was purchased by ASSA ABLOY, the global leader in door opening solutions. This greatly expanded design and development capabilities and expanded the product offering to customers. This offering includes many coordinating products with other ASSA ABLOY Group companies through the Good Design Studio.



Custom Designs

Design your own hardware! Whether it is a modification of a standard product or a completely unique design, we will quote your design and offer suggestions for best mounting applications. We take special pride in our custom products. For more information, please contact our sales staff.



Rockwood Architectural Door Pulls

The alluring warmth of warm wood, smooth leather, clean and appealing lines. Just a few words to describe our beautiful architectural door pulls. With endless design options to choose from, our pulls will add contemporary beauty to any door opening.

Refer to the Rockwood Architectural Door Pulls catalog, found on our web site at www.assaabloydooraccessories.us

the good design studio

The Good Design Studio – your resource for beautiful doors, frames and hardware from ASSA ABLOY Group brands. Visit www.thegooddesignstudio.com to learn more.



CORBIN RUSSWIN 107 and SARGENT ME lever



MCKINNEY 2 knuckle hinge with round end tips



ROCKWOOD small door pull



ASSA ABLOY is a member of the USGBC and CaGBC. U.S. Green Building Council logo is a trademark owned by the U.S. Green Building Council and is used with permission.

LEED Certification Contribution

ASSA ABLOY can help to achieve prerequisites and accumulate points in several categories and credit areas of LEED. When you select a Rockwood stainless steel door pull for your LEED certified building project, you are using a product that is made from a minimum 75% post industrial waste and is 100% recyclable. Additionally these pulls can usually be refinished to their original appearance any time in the life of the building, eliminating the need for replacement when a renovation is conducted. For further information, please call 1-800-458-2424 or refer to our website www.assaabloydooraccessories.us.

800-458-2424 | www.assaabloydooraccessories.us
Check the web site for the up-to-date catalog

Copyright © 2012-2020, ASSA ABLOY Accessories and Door Controls Group, Inc. All rights reserved. Reproduction in whole or in part without the express written permission of ASSA ABLOY Accessories and Door Controls Group, Inc. is prohibited.

ASSA ABLOY
Opening Solutions

Experience a safer
and more open world

Sales & Support

Sales

Rockwood Products are represented by a number of sales agencies as well as ASSA ABLOY Door Security Solutions representatives. To locate the representative for your area visit the Sales Representative map in the Contact Us area at www.assaabloydooraccessories.us, or call 1-800-458-2424.

Ordering Information

Orders are accepted with the understanding that they will be billed at the prices in effect at time of shipment. Prices are subject to change without notice. We reserve the right to decline the whole or part of orders in which the price or quantity of goods is not acceptable to us.

Easy Order Placement

By Phone: 1-800-458-2424 Monday through Friday, 8:00 am ET to 7:30 pm ET

By Fax: Orders may be faxed to 1-800-922-9212

By Email: orders.rockwood@assaabloy.com

By Internet: <http://extranet.assaabloydss.com/> and select Order Entry under the Customer Service Menu

Webshop: Architectural Door Accessories WebShop:
<https://accessories.assaabloy.com/>

Canada:

By Phone: 1-800-461-3007 Monday through Friday 8:00am ET to 4:30pm ET

By Fax: Orders may be faxed to 1-800-461-8989

By Email: cavau-orders@assaabloy.com

By Internet: <http://extranet.assaabloydss.ca/> and select Order Entry under the Customer Service Menu

Technical Support

Do you have a question? Let us help. Customer Service Representatives are available Monday through Friday, 8:00 am ET to 7:30 pm ET at 1-800-458-2424.

Our website is available 24/7 with current catalogs, sell sheets and the most up-to-date templates.

Visit www.assaabloydooraccessories.us



Terms & Conditions

Terms and Conditions of Sale

Terms: 1% 15 days, net 30 days

Remit Payment To: PNC Bank/Rockwood,
P.O. Box 644489, Pittsburgh, PA 15264-4489

For Terms & Conditions and Warranty information pertaining to product sales in Canada, please visit www.assaabloy.ca/terms

Freight Policy

All prices are F.O.B. Rockwood, Pennsylvania, and/or Ventura, California. Full freight will be allowed on shipments of \$1,000.00 net and over within the continental limits of the United States (excluding Alaska and Hawaii). All shipments are routed most cost effective route of our choice. We reserve the right to designate the carrier.

Special Order Material

Special items made to your specifications are not returnable. These items are not subject to cancellation without consideration of expense involved at the cancellation date.

Samples

Saleable samples will be charged at regular prices.

Shortages

Claims for shortages must be made within 30 days of invoice date.

Templates

Upon request we will furnish templates for any of our standard items of manufacture. Commonly used templates are available on our website at www.assaabloydooraccessories.us.

BHMA/ANSI Specifications

We have listed ANSI cross-reference numbers throughout our catalogs and website. The cross-reference can be relied on for design equivalence reference.

ASSA ABLOY
Opening Solutions

Experience a safer
and more open world

800-458-2424 | www.assaabloydooraccessories.us

Check the web site for the up-to-date catalog

Copyright © 2012-2020, ASSA ABLOY Accessories and Door Controls Group, Inc. All rights reserved. Reproduction in whole or in part without the express written permission of ASSA ABLOY Accessories and Door Controls Group, Inc. is prohibited.

Architectural Finishes

Most Rockwood products are available in all of the following architectural finishes. The catalog indicates exceptions. This finish list is grouped by base metal.

Base Metal	Description	Rockwood Code	BHMA Code
Aluminum	Satin	US27	627
Aluminum	Clear anodized	US28	628
Aluminum	Light bronze anodized	311	—
Aluminum	Medium bronze anodized	312	—
Aluminum	Dark bronze anodized	313	710
Aluminum	Extra dark bronze anodized	314	—
Aluminum	Black anodized	315	711
Aluminum	White powder coat	WPC	—
Aluminum	Red powder coat	RPC	—
Aluminum	Black powder coat	BPC	—
Brass	Polished clear coated	US3	605
Brass	Polished no coating	US3NL	—
Brass	Satin clear coated	US4	606
Brass	Satin oxidized relieved	US5	609
Brass	Satin nickel plated clear coated	US15	619
Brass	Satin nickel blackened relieved clear coated	US15A	620
Brass	Flat black powder coated	US19	622
Brass	Polished chrome plated	US26	625
Brass	Satin chrome plated	US26D	626

Base Metal	Description	Rockwood Code	BHMA Code
Bronze	Polished clear coated	US9	611
Bronze	Satin clear coated	US10	612
Bronze	Black oxidized bronze oil rubbed	US10A	722
Bronze	Satin oxidized oil rubbed	US10B*	613
Bronze	Oxidized equivalent	US10BE	613E
Bronze	Satin oxidized clear coated	US10BL	614
Stainless Steel	Polished	US32	629
Stainless Steel	Satin	US32D	630
Bronze	Satin dark statuary	US20A	624

*US10B is a living finish and will patina over time

Special Finishes (see descriptions below)

Stainless Steel	Satin MicroShield® coated	US32DMS**	—
Stainless Steel	Polished 316 alloy	US32316**	—
Stainless Steel	Satin 316 alloy	US32D316**	—
	Black Suede Powder Coat	BSP	—
	White Suede Powder Coat	WSP	—

US32DMS (MicroShield®):

As part of its promise to provide innovative solutions to their customers, ASSA ABLOY Group companies offer the MicroShield® technology, a silver-based antimicrobial coating designed to inhibit the spread of germs and bacteria.

US32316 and US32D316:

Made from alloy 316 stainless steel containing molybdenum and extra nickel giving it substantially higher corrosion resistance than the standard stainless steels typically used in door hardware. This finish is ideal for use in coastal, urban, and industrial areas that have harsh environmental conditions. 32316 (polish) finishes offer the best corrosion resistance and should be used in caustic environments.



MicroShield® is a registered trademark of Yale Security Inc., an ASSA ABLOY Group company.



Finish Tips

Polished Brass

Polished brass is a beautiful finish that does not normally weather very well outdoors. Rockwod products use a very durable baked on clear powder coat on most door pulls and push bars. In indoor usage, this finish is extremely durable.

Stainless Steel

Stainless steel is one of the most durable materials used in architecture; however there are many types with different properties and different levels of corrosion resistance. In most indoor (except chlorine and other harsh chemical exposure) and many outdoor (mildly corrosive) environments our standard stainless steel will perform exceeding well. It is best maintained by periodic water washing. If your job site has road salt, marine salt air, industrial, or urban pollution, we recommend the use of molybdenum bearing alloy 316 stainless steel. Specify US32316 or US32D316. To enhance the corrosion resistance of stainless steel, use the polished finish (US32) in place of the satin finish (US32D). Minute particles of dirt and debris can lodge in the microscopic crevices of the satin finish more readily than on a smooth surface promoting corrosion. The mirror smooth surface of the polished finish has no rough surface to retain microscopic dirt or debris.

Heat Resistant

Exterior hot sunny climates call for a finish that is resistant to heat. We recommend our white powder coat finish (WPC). This durable exterior finish reflects much of the heat rays and is substantially cooler to the touch than stainless steel or other finishes.

Anti-Microbial Protection

MicroShield® (US32DMS) is the ideal finish for hospitals, schools, laboratories, assisted living facilities, public restroom areas, and anywhere there is a concern to control bacteria growth for demanding standards of cleanliness. Contact our customer service department for more detailed information.

Finish Sample Displays

Educational and informative displays are available showing our most popular finishes.

How to Size Push Bars

Flush Doors

Door width:

- Minus 5" for bent end bars
- Minus 5" for square end post mount bars
- Minus 7" for round end post mount bars

Stile and Rail Doors or Doors with Lites

Door width:

- Minus width of one stile

CAUTION: Always confirm bars will not interfere with jamb or cause pinching hazard.

CAUTION: On narrow stile doors, be sure push bar base fits on the stile and bar does not interfere with the stop.

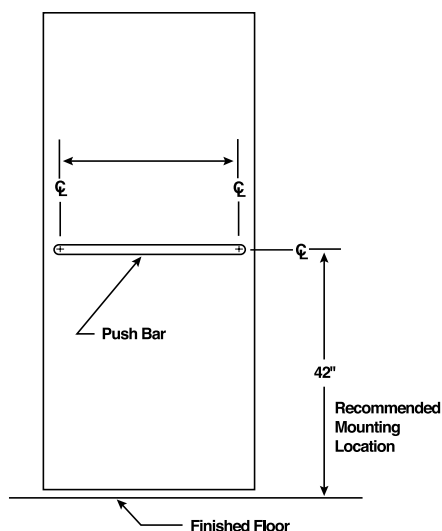

Handing of Doors

The handing of a door is determined from the outside of the opening.

Standing outside the door:

- If the hinges are on the right, it is a right hand door
- If the hinges are on the left, it is a left hand door
- If the door opens away from you, it is a regular bevel door
- If the door opens toward you, it is a reverse bevel door

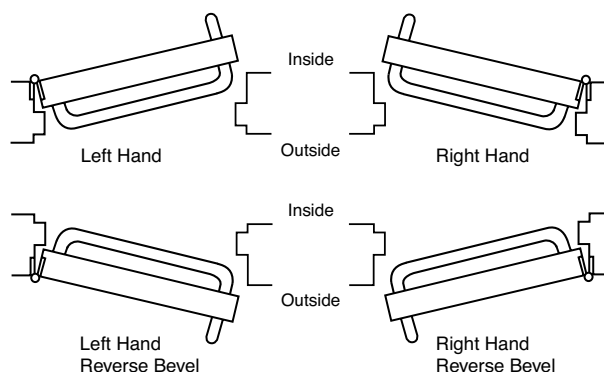

Mounting Types for Push Bars No. 10 through No. 45 and No. 50, No. 51, No. 52

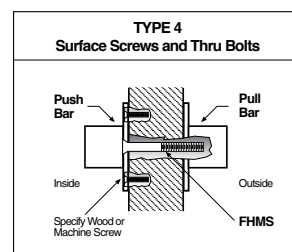
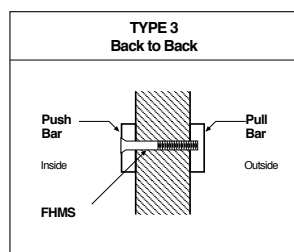
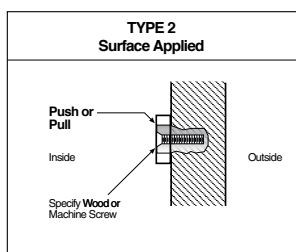
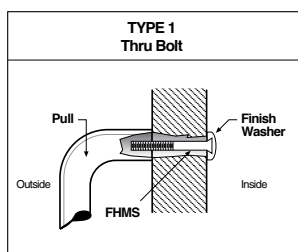



Push Bar No. 10-PB

- Material:** Brass and Bronze
- Finishes:** Available in standard architectural finishes (see page 9)
- Mounting:** Metal door: type 2, surface, #8 - 32 x 3/4" OH MS
Wood door: type 2, surface, #8 x 3/4" OH SMS
- Ordering:** Specify CTC, door type, mounting, and finish
- Features:** Can be field cut if necessary

No.	Material Size	Base	Projection	Clearance	Weight	ANSI A156.6
10-PB	3/8" x 1 1/2"	1 1/2" x 2 7/8"	1 1/4"	5/8"	6.9 lbs.	J501



Push Bars No. 11-PB, 12-PB

- Material:** Aluminum, brass, bronze, stainless steel
- Finishes:** Available in standard architectural finishes, except US32 (see page 9)
- Mounting:** **No. 11:**
Metal door: type 2, surface, 1/4 - 20 x 1 1/2" MS & #8 - 32 x 3/4" OH MS
Wood door: type 2, surface, #12 x 3/4" WS & #8 x 3/4" OH SMS
- No. 12:**
Metal and wood door: type 1, 1/4 - 20 x 2 1/4" thru bolt and finish washer (standard 1 3/4" door)
- Ordering:** Specify CTC, door type, mounting and finish
- Options:** Advise if door thickness is other than 1 3/4"

No.	Material Size	Base	Projection	Clearance	Weight	ANSI A156.6
11-PB	3/8" x 1 1/2"	1" x 3" x 1/8"	2"	1 5/8"	6.2 lbs.	J501
12-PB (less base plate)	3/8" x 1 1/2"	3/8" x 1 1/2"	1 3/8"	1 1/2"	6.2 lbs.	J501

ASSA ABLOY
Opening Solutions

Experience a safer
and more open world

800-458-2424 | www.assaabloydooraccessories.us
Check the web site for the up-to-date catalog

Copyright © 2012-2020, ASSA ABLOY Accessories and Door Controls Group, Inc. All rights reserved. Reproduction in whole or in part without the express written permission of ASSA ABLOY Accessories and Door Controls Group, Inc. is prohibited.



Push Bars No. 14-PB, 15-PB

- Material:** Aluminum, brass, bronze, stainless steel
- Finishes:** Available in standard architectural finishes, except US32 (see page 9)
- Mounting:** Metal and wood door: type 1, 1/4-20x2 1/4" thru bolt & finish washer (standard 1 3/4" door)
- Ordering:** Specify CTC, door type, mounting, and finish
- Options:** Advise if door thickness is other than 1 3/4"

No.	Material Size	Base	Projection	Clearance	Weight	ANSI A156.6
14-PB	3/8" x 1 1/2"	1 1/2" x 2 x 1/8"	2"	1 5/8"	6.3 lbs.	J501
15-PB (less base plate)	3/8" x 1 1/2"	3/8" x 1 1/2"	1 7/8"	1 1/2"	6.1 lbs.	J501



Push Bars No. 18-PB, 19-PB

- Material:** Aluminum, brass, stainless steel, bronze
- Finishes:** Available in standard architectural finishes, except US32 (see page 9)
- Mounting:** **No. 18:**
Metal door: type 2, surface,
1/4-20 x 1" and #8-32 x 3/4" OH MS
Wood door: type 2, surface,
#12 x 1 1/4" FH WS and #8 x 3/4" OH SMS
- No. 19:**
Metal door: type 1, thru bolt, 1/4-20 x 1 OH MS
Wood door: type 1, thru bolt,
#12 x 1 1/4" FH WS, finish washer
- Ordering:** Specify CTC, door type, mounting, and finish
- Options:** Advise if door thickness is other than 1 3/4"

No.	Material Size	Base	Projection	Clearance	Weight	ANSI A156.6
18-PB	3/8" x 1 1/2"	1" x 3 x 1/8"	2 1/8"	1 3/4"	6.2 lbs.	J501
19-PB (less base plate)	3/8" x 1 1/2"	3/8" x 1 1/2"	2"	1 5/8"	6.2 lbs.	J501



Pull Bars No. 20-PB, 21-PB

- Material:** Aluminum, brass, bronze, stainless steel
- Finishes:** Available in standard architectural finishes, except US32 (see page 9)
- Mounting:** Metal and wood door: type 1, $\frac{1}{4}$ -20 x $2\frac{1}{4}$ " thru bolt and finish washer (standard $1\frac{3}{4}$ " door)
- Ordering:** Specify CTC, door type, and finish
- Options:**
- Ideal for engraving
 - Advise if door thickness is other than $1\frac{3}{4}$ "

No.	Material Size	Base	Projection	Clearance	Space	Weight	ANSI A156.6
20-PB	$\frac{3}{8}$ " x $1\frac{1}{4}$ "	$1\frac{1}{2}$ " x $1\frac{1}{4}$ "	$2\frac{1}{4}$ "	$1\frac{7}{8}$ "	8"	12.3 lbs.	J502
21-PB	$\frac{3}{8}$ " x $1\frac{1}{2}$ "	$1\frac{1}{2}$ " x $1\frac{1}{2}$ "	$2\frac{1}{4}$ "	$1\frac{7}{8}$ "	8"	14.7 lbs.	J502

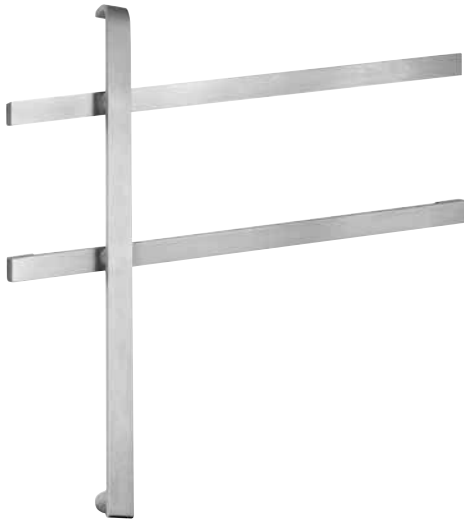

Pull Bars No. 22-PB, 23-PB

- Material:** Aluminum, brass, bronze, stainless steel
- Finishes:** Available in standard architectural finishes, except US32 (see page 9)
- Mounting:** Metal and wood door: type 1, $\frac{1}{4}$ -20 x $2\frac{1}{4}$ " thru bolt and finish washer (standard $1\frac{3}{4}$ " door)
- Ordering:** Specify CTC, door type, and finish
- Options:** Ideal for engraving
- Other:**
- Pull length is 42" from top post to bottom post
 - Advise if door thickness is other than $1\frac{3}{4}$ "

No.	Material Size	Base	Projection	Clearance	Space	Weight	ANSI A156.6
22-PB	$\frac{3}{8}$ " x $1\frac{1}{4}$ "	$1\frac{1}{2}$ " x $1\frac{1}{4}$ "	$2\frac{1}{4}$ "	$1\frac{7}{8}$ "	8"	16.7 lbs.	J503
23-PB	$\frac{3}{8}$ " x $1\frac{1}{2}$ "	$1\frac{1}{2}$ " x $1\frac{1}{2}$ "	$2\frac{1}{4}$ "	$1\frac{7}{8}$ "	8"	20.0 lbs.	J503

ASSA ABLOY
Opening Solutions

Experience a safer
and more open world

800-458-2424 | www.assaabloydooraccessories.us
Check the web site for the up-to-date catalog

Copyright © 2012-2020, ASSA ABLOY Accessories and Door Controls Group, Inc. All rights reserved. Reproduction in whole or in part without the express written permission of ASSA ABLOY Accessories and Door Controls Group, Inc. is prohibited.



Push Bars No. 25-PB, 26-PB

- Material:** Aluminum, brass, bronze, stainless steel
- Finishes:** Available in standard architectural finishes, except US32 (see page 9)
- Mounting:** Metal and wood door: type 1, 1/4-20 x 2 1/4" thru bolt and finish washer (standard 1 3/4" door)
Metal door: type 2, surface, 1/4-20 MS
Wood door: type 2, surface, #12 WS
- Ordering:** Specify CTC, door type, mounting, and finish
- Options:** Advise if door thickness is other than 1 3/4"

No.	Material Size	Base	Projection	Clearance	Space	Weight	ANSI A156.6
25-PB	3/8" x 1 1/4"	1 1/2" x 1 1/4"	3/4"	3/8"	—	4.8 lbs.	J501
26-PB	3/8" x 1 1/2"	1 1/2" x 1 1/2"	3/4"	3/8"	—	5.8 lbs.	J501

Push & Pull Bar Sets No. 27-PB, 28-PB, 29-PB, 30-PB

- Material:** Aluminum, brass, bronze, stainless steel
- Finishes:** Available in standard architectural finishes, except US32 (see page 9)
- Mounting:** Metal and wood door: type 3, back to back, 1/4-20 MS
- Ordering:** Specify CTC, door type, and finish

No.	Material Size	Space	Weight	ANSI A156.6
27-PB	Set consists of 1 #20-PB and 2 #25-PB	8"	21.9 lbs.	J504
28-PB	Set consists of 1 #21-PB and 2 #26-PB	8"	26.3 lbs.	J504
29-PB	Set consists of 1 #22-PB and 2 #25-PB	8"	26.3 lbs.	J504
30-PB	Set consists of 1 #23-PB and 2 #26-PB	8"	31.6 lbs.	J504

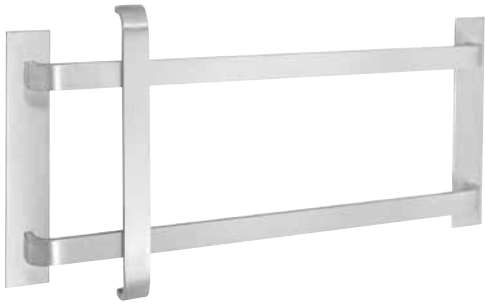

Pull Bars No. 31-PB, 32-PB

- Material:** Aluminum, brass, bronze, stainless steel
- Finishes:** Available in standard architectural finishes, except US32 (see page 9)
- Mounting:** Metal and wood door: type 1, thru bolt, 1/4" - 20 x 2 1/4" FH MS, finish washers (standard 1 3/4" door)
- Ordering:** Specify CTC, door type, and finish
- Options:**
- Ideal for engraving
 - Advise if door thickness is other than 1 3/4"

No.	Material Size	Base	Projection	Clearance	Space	Weight	ANSI A156.6
31-PB	3/8" x 1 1/4"	2" x 12" x 1/8"	2"	1 5/8"	8"	12.8 lbs.	J502
32-PB	3/8" x 1 1/2"	2" x 12" x 1/8"	2"	1 5/8"	8"	15.4 lbs.	J502

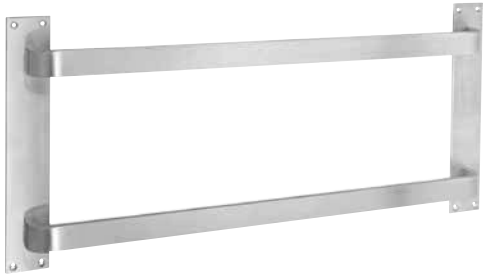

Push Bars No. 33-PB, 34-PB

- Material:** Aluminum, brass, bronze, stainless steel
- Finishes:** Available in standard architectural finishes, except US32 (see page 9)
- Mounting:** Metal door: type 2, surface, #8 - 32 x 3/4" OH MS
Wood door: type 2, surface, #8 x 3/4" OH SMS
- Ordering:** Specify CTC, door type, mounting, and finish
- Options:** Ideal for engraving

No.	Material Size	Base	Projection	Clearance	Space	Weight	ANSI A156.6
33-PB	3/8" x 1 1/4"	2" x 12" x 1/8"	1 5/8"	1 1/4"	8"	10.9 lbs.	J502
34-PB	3/8" x 1 1/2"	2" x 12" x 1/8"	1 5/8"	1 1/4"	8"	13.1 lbs.	J502

Push and Pull Bar Sets No. 35-PB, 36-PB

- Material:** Aluminum, brass, stainless steel, bronze
- Finishes:** Available in standard architectural finishes, except US32 (see page 9)
- Mounting:** Metal door: type 4, back to back, 1/4" - 20 x 2 1/4" & #8 - 32 x 3/4" OH MS
Wood door: type 4, back to back, 1/4" - 20 x 2 1/4" & #8 x 3/4" OH SMS
- Ordering:** Specify CTC, door type, mounting, and finish

No.	Material Size	Space	Weight	ANSI 156.6
35-PB	Set consists of 1 #31-PB & 1 #33-PB	8"	23.7 lbs.	J504
36-PB	Set consists of 1 #32-PB & 1 #34-PB	8"	28.5 lbs.	J504

ASSA ABLOY
Opening Solutions

Experience a safer
and more open world

800-458-2424 | www.assaabloydooraccessories.us
Check the web site for the up-to-date catalog

Copyright © 2012-2020, ASSA ABLOY Accessories and Door Controls Group, Inc. All rights reserved. Reproduction in whole or in part without the express written permission of ASSA ABLOY Accessories and Door Controls Group, Inc. is prohibited.

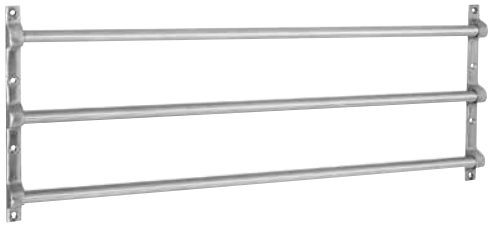

Screen Door Guard No. 40-PB

- Material:** Brass and Bronze
- Finishes:** Available in standard architectural finishes (see page 9)
- Mounting:** Metal door: type 2, surface, #8 - 32 x 3/4" OH MS
Wood door: type 2, surface, #8 x 3/4" OH SMS
- Ordering:** Specify CTC, door type, mounting, and finish

No.	Material Size	Base	Projection	Clearance	Bar Space	Weight
40-PB	5/8" tube	5/8" x 9 5/8"	1 1/8"	3/8"	3 1/2"	4.5 lbs.



Screen Door Guard No. 41-PB

- Material:** Brass and Bronze
- Finishes:** Available in standard architectural finishes (see page 9)
- Mounting:** Metal door: type 2, surface, #8 - 32 x 3/4" OH MS
Wood door: type 2, surface, #8 x 3/4" OH SMS
- Ordering:** Specify CTC, door type, mounting, and finish

No.	Material Size	Base	Projection	Clearance	Bar Space	Weight
41-PB	5/8" tube	5/8" x 6 1/8"	1 1/8"	3/8"	3 1/2"	2.9 lbs.



Screen Door Guard No. 42-PB

- Material:** Brass and Bronze
- Finishes:** Available in standard architectural finishes (see page 9)
- Mounting:** Metal door: type 2, surface, #8 - 32 x 3/4" OH MS
Wood door: type 2, surface, #8 x 3/4" OH SMS
- Ordering:** Specify CTC, door type, mounting, and finish

No.	Material Size	Base	Projection	Clearance	Bar Space	Weight
42-PB	5/8" tube	5/8" x 2 5/8"	1 1/8"	3/8"	—	1.6 lbs.



Push Bars No. 43-PB, 44-PB

- Material:** Aluminum, brass, bronze, stainless steel
- Finishes:** Available in standard architectural finishes, except US32 (see page 9)
- Mounting:** Metal and wood door: type 1, $\frac{1}{4}$ -20x2 $\frac{1}{4}$ " thru bolt and finish washer (standard 1 $\frac{3}{4}$ " door)
- Ordering:** Specify CTC, door type, mounting, and finish
- Other:** Ideal for engraving or logos
- Options:** Advise if door thickness is other than 1 $\frac{3}{4}$ "

No.	CTC	Material Size	Base	Projection	Clearance	Weight	ANSI 156.6
43-PB	Specify	$\frac{3}{8}$ " x 3"	1 $\frac{1}{2}$ " x 4 $\frac{1}{2}$ " x $\frac{1}{8}$ "	2"	1 $\frac{5}{8}$ "	10.5 lbs.	J501
44-PB (less base plate)	Specify	$\frac{3}{8}$ " x 3"	—	1 $\frac{7}{8}$ "	1 $\frac{1}{2}$ "	10.1 lbs.	J501



Push Bar No. 45-PB

- Material:** Aluminum, brass, bronze, stainless steel
- Finishes:** Available in standard architectural finishes, except US32 (see page 9)
- Mounting:** Metal and wood door: type 1, $\frac{1}{4}$ -20x2 $\frac{1}{4}$ " thru bolt and finish washer (standard 1 $\frac{3}{4}$ " door)
- Ordering:** Specify CTC, door type, mounting, and finish
- Other:** Ideal for engraving or logos
- Options:** Advise if door thickness is other than 1 $\frac{3}{4}$ "

No.	CTC	Material Size	Base	Projection	Clearance	Weight	ANSI 156.6
45-PB	Specify	$\frac{3}{8}$ " x 3"	1 $\frac{1}{2}$ " x 3"	$\frac{3}{4}$ "	$\frac{3}{8}$ "	9.9 lbs.	J501

ASSA ABLOY
Opening Solutions

Experience a safer
and more open world

800-458-2424 | www.assaabloydooraccessories.us
Check the web site for the up-to-date catalog

Copyright © 2012-2020, ASSA ABLOY Accessories and Door Controls Group, Inc. All rights reserved. Reproduction in whole or in part without the express written permission of ASSA ABLOY Accessories and Door Controls Group, Inc. is prohibited.



Pull Bar No. 50-PB

- Material:** Brass, bronze
- Finishes:** Available in standard architectural finishes (see page 9)
- Mounting:** Metal and wood door: type 1, $\frac{1}{4}$ -20 x $2\frac{1}{4}$ " thru bolt & finish washer (standard $1\frac{3}{4}$ " door)
Wood door: type 2 surface, #8 x $\frac{3}{4}$ " OH SMS
- Ordering:** Specify CTC, door type, and finish
- Other:** Cast slip-on end brackets
- Options:** Advise if door thickness is other than $1\frac{3}{4}$ "

No.	Material Size	Base	Projection	Clearance	Space	Weight	ANSI 156.6
50-PB	1" dia.	2" dia.	$3\frac{1}{8}$ "	$2\frac{5}{8}$ "	$7\frac{1}{2}$ "	7.6 lbs.	J502



Push Bar and Door Pull No. 51-PB, 53-PB

- Material:** Brass, bronze
- Finishes:** Available in standard architectural finishes (see page 9)
- Mounting:** Metal and wood door: type 1, thru bolt, $\frac{1}{4}$ -20 x $2\frac{1}{4}$ " MS, finish washers (standard $1\frac{3}{4}$ " door)
Metal door: type 2, surface, #8 - 32 x $\frac{3}{4}$ " OH MS
Wood door: type 2, surface, #8 x $\frac{3}{4}$ " OH SMS
- Ordering:** Specify door type, mounting, and finish
- Other:** Cast slip-on end brackets
- Options:** Advise if door thickness is other than $1\frac{3}{4}$ "

No.	Material Size	CTC	Base	Projection	Clearance	Weight	ANSI 156.6
51-PB	1" dia.	Specify	2" dia.	$2\frac{3}{8}$ "	$1\frac{1}{4}$ "	3.1 lbs.	J501
53-PB	1" dia.	12"	2" dia.	$2\frac{3}{8}$ "	$1\frac{1}{4}$ "	1.5 lbs.	J401

Push and Pull Bar Set No. 52-PB

- Material:** Brass, bronze
- Finishes:** Available in standard architectural finishes (see page 9)
- Mounting:** Metal door: type 4, back to back, $\frac{1}{4}$ -20 x $2\frac{1}{4}$ " MS and #8 - 32 x $\frac{3}{4}$ " OH MS
Wood door: type 4, back to back, $\frac{1}{4}$ -20 x $2\frac{1}{4}$ " MS and #8 x $\frac{3}{4}$ " OH SMS
- Ordering:** Specify CTC, door type, mounting, and finish
- Other:** Cast slip-on end brackets

No.	Material Size	Weight	ANSI 156.6
52-PB	Set consists of 1 #50-PB and 2 #51-PB	30.9 lbs.	J504

Typical Mounting

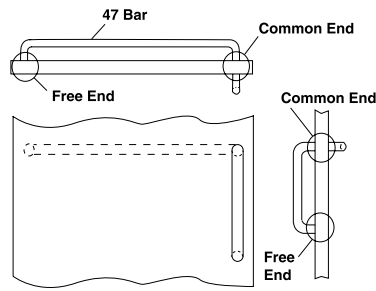

Free End Details

Thru Bolt

Wood or Metal Door - Type 1

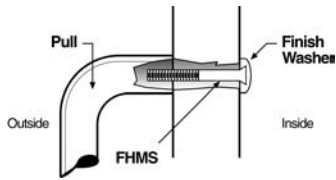

Type	Bolt Size	Drill Size	
		Wood	Metal
1	1/4 - 20	9/32	9/32
1HD	5/16 - 18	11/32	11/32
1XHD	3/8 - 16	13/32	13/32

Wood or Metal Door - Type 12

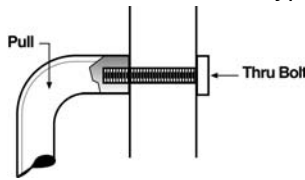

Type	Bolt Size	Drill Size	
		Wood	Metal
12	1/4 - 20	9/32	9/32
12HD	5/16 - 18	11/32	11/32
12XHD	3/8 - 16	13/32	13/32

Glass Door - Type 15

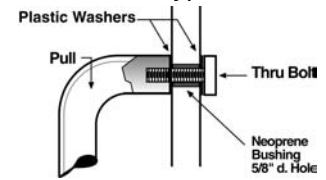

Type	Bolt Size	Drill Size - Glass
15	1/4 - 20	5/8
15HD	5/16 - 18	5/8
15XHD	3/8 - 16	5/8

Surface Concealed

Metal Door - Type 6

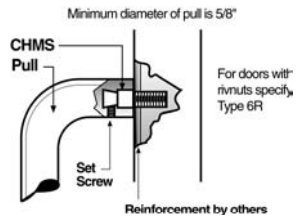

Type	Bolt Size	Drill Size - Metal
6	1/4 - 20	1/4 - 20 tap
6HD	5/16 - 18	5/16 - 18 tap

Wood Door - Type 8

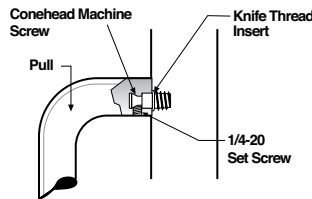

Type	Bolt Size	Drill Size - Wood
8	1/4 - 20	23/64 X 9/16 dp
8HD	5/16 - 18	7/16 X 9/16 dp

Metal Door - Type 17

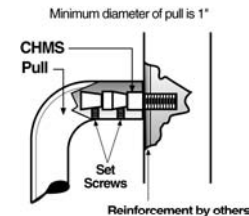

Type	Bolt Size	Drill Size - Metal
17	1/4 - 20	1/4 - 20 tap
17HD	5/16 - 18	5/16 - 18 tap

Common End Details

Wood or Metal Door - Type 5

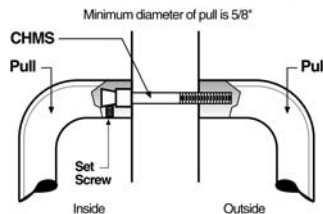

Type	Bolt Size	Drill Size	
		Wood	Metal
5	1/4 - 20	9/32	9/32
5HD	5/16 - 18	11/32	11/32

Glass Door - Type 13

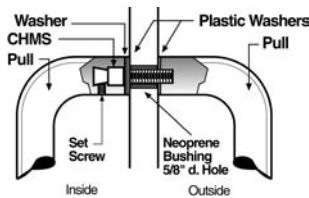

Type	Bolt Size	Drill Size - Glass
13	1/4 - 20	5/8
13HD	5/16 - 18	5/8

NOTE: Heavy Duty (HD/XHD) mounting features hex drive for positive tightening and large overall size for superior strength. Recommended for high frequency and rough service openings.

ASSA ABLOY
Opening Solutions

Experience a safer
and more open world

800-458-2424 | www.assaabloydooraccessories.us
Check the web site for the up-to-date catalog

Copyright © 2012-2020, ASSA ABLOY Accessories and Door Controls Group, Inc. All rights reserved. Reproduction in whole or in part without the express written permission of ASSA ABLOY Accessories and Door Controls Group, Inc. is prohibited.



Series 47 Push Bar No. SP47

- Material:** Aluminum, brass, bronze, stainless steel
- Finishes:** Available in standard architectural finishes; US32DMS, US32D316, US32316, white (WPC), red (RPC), and black (BPC) powder coat finishes (see page 9)
- Mounting:** Metal and wood door: type 1, 1/4 - 20x2 1/4" thru bolt and finish washer (standard 1 3/4" door)
NOTE: See page A10 for detailed mounting drawings
- Ordering:** Specify CTC, handing, door type, and finish
- Options:**
- Engraving "PUSH" or "PULL"
 - Advise if door thickness is other than 1 3/4"

No.	CTC	Material Size	Base	Projection	Clearance	Weight	ANSI 156.6
SP47	Specify	1" dia.	1" dia.	2 3/4"	1 1/2"	8.5 lbs.	J501



No. 47



No. 47-2



No. 47-3

Series 47 Push Bar No. 47-PB, 47-2-PB, 47-3-PB, 48-PB

- Material:** Aluminum, brass, bronze, stainless steel
- Finishes:** Available in standard architectural finishes, US32DMS, US32D316, US32316, white (WPC), red (RPC), and black (BPC) powder coat finishes (see page 9)
- Mounting:**
- No. 47, 47-2, 47-3:**
Metal and wood door: type 1, 1/4 - 20x2 1/4" thru bolt and finish washer (standard 1 3/4" door)
Metal door: type 6, concealed, 1/4 - 20 CH MS
- No. 48 (not shown):**
Metal and wood door: type 1, 1/4 - 20x2 1/4" thru bolt and finish washer (standard 1 3/4" door)
NOTE: See page A10 for detailed mounting drawings
- Ordering:** Specify CTC, door type, mounting, and finish
- Options:**
- Engraving "PUSH" or "PULL". Specify handing
 - Heavy duty versions of most fastening types available — use suffix HD to fastening type number (47 Type 6HD)
 - Advise if door thickness is other than 1 3/4"

PUSH

Engraved

No.	CTC	Material Size	Base	Projection	Clearance	Weight	ANSI 156.6
47-PB	Specify	1" dia.	1" dia.	2 3/4"	1 3/4"	8.5 lbs.	J501
47-2-PB	Specify	1" dia.	1" dia.	2 3/4"	1 3/4"	17.0 lbs.	J501
47-3-PB	Specify	1" dia.	1" dia.	2 3/4"	1 3/4"	25.5 lbs.	J501
48-PB	Specify	3/4" dia.	3/4" dia.	2 3/4"	1 3/4"	4.5 lbs.	J501



No. BP47



No. BP47-2

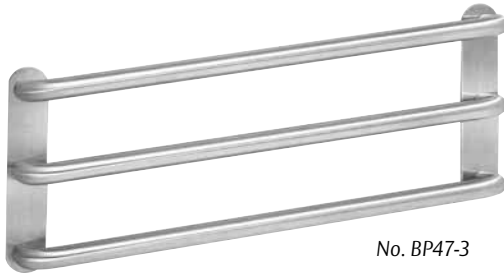

No. BP47-3

Series 47 Push Bar No. BP47, BP47-2, BP47-3

Material: Aluminum, brass, bronze, stainless steel

Finishes: Available in standard architectural finishes, US32DMS, US32D316, US32316, white (WPC), red (RPC), and black (BPC) powder coat finishes (see page 9)

Mounting: No. BP47: Metal and wood door: type 1, 1/4 - 20 x 2 1/4" thru bolt and finish washer (standard 1 3/4" door)

Metal door: type 6, concealed, 1/4 - 20 CH MS x 1/2" thread

No. BP47-2, BP47-3:

Metal and wood door: type 1, 1/4 - 20 x 2 1/4" thru bolt and finish washer (standard 1 3/4" door)

Metal door: type 2, surface, #8 - 32 x 3/4" OH MS

Wood door: type 2, surface, #8 x 3/4" OH SMS

Metal door: type 6, concealed, 1/4 - 20 CH MS x 1/2" thread

NOTE: See page A10 for detailed mounting drawings

Ordering: Specify CTC, door type, mounting and finish.

- Options:**
- Engraving "PUSH" or "PULL". Specify handing
 - Heavy duty versions of most fastening types available — use suffix HD to fastening type number (BP47 Type 6HD)
 - Advise if door thickness is other than 1 3/4"

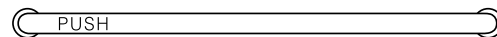

Engraved

No.	CTC	Material Size	Base	Projection	Clearance	Weight	ANSI 156.6
BP47	Specify	1" dia.	1 1/4" dia.	2 7/8"	1 7/8"	9.0 lbs.	J501
BP47-2	Specify	1" dia.	2" x 6"	2 7/8"	1 7/8"	18.0 lbs.	J501
BP47-3	Specify	1" dia.	2" x 10"	2 7/8"	1 7/8"	27.5 lbs.	J501

ASSA ABLOY
Opening Solutions

Experience a safer
and more open world

800-458-2424 | www.assaabloydooraccessories.us

Check the web site for the up-to-date catalog

Copyright © 2012-2020, ASSA ABLOY Accessories and Door Controls Group, Inc. All rights reserved. Reproduction in whole or in part without the express written permission of ASSA ABLOY Accessories and Door Controls Group, Inc. is prohibited.

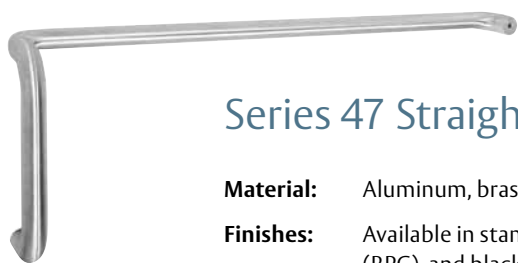

Series 47 Straight Single Bar Sets

Material: Aluminum, brass, bronze, stainless steel

Finishes: Available in standard architectural finishes, US32DMS, US32D316, US32316, white (WPC), red (RPC), and black (BPC) powder coat finishes (see page 9).

Mounting:	Door	Pull Free End	Push Free End	Common End	Description	Mounting Spec. No.
	Metal & wood	1	1	5	Back to back & thru bolt	T3**
	Metal	6	6	5	Back to back & concealed	T4
	Wood	8	8	5	Back to back & concealed	T5
	Metal & wood	12	12	5	Back to back & decorative bolt	T1
	Glass	15	15	13	Back to back & thru bolt	T2

** T3 is the standard mounting method for metal and wood doors.

NOTE: See page A10 for detailed mounting drawings

Ordering: Specify product number, mounting, door type, push bar CTC, and finish (11247 T3, wood door, 33" CTC, US32D316)

Other: See page A1 on "How To" size push bars

Options:

- Engraving "PUSH" or "PULL". Specify handing
- Base plates available similar to those shown on page A12 — use BP prefix (BP11047) when ordering
- Heavy duty versions of most fastening types available — use suffix HD to fastening type number (11047 T3HD)

NOTE: Pull bar Projection : 3-1/2" for Stainless Steel and 3" for Aluminum

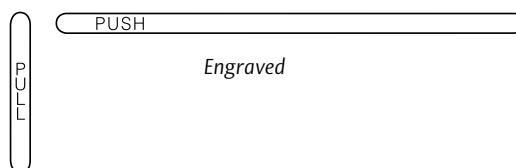

No.	Material Size	Pull			Push		Weight	ANSI 156.6
		CTC	Projection	Clearance	Projection	Clearance		
11047	1" dia.	8"	3"	2"	2 ³ / ₄ "	1 ³ / ₄ "	11.5 lbs.	J504
111A47	1" dia.	9"	3"	2"	2 ³ / ₄ "	1 ³ / ₄ "	11.7 lbs.	J504
11147	1" dia.	10"	3"	2"	2 ³ / ₄ "	1 ³ / ₄ "	12.0 lbs.	J504
11247	1" dia.	12"	3"	2"	2 ³ / ₄ "	1 ³ / ₄ "	12.5 lbs.	J504
11847	1" dia.	18"	3"	2"	2 ³ / ₄ "	1 ³ / ₄ "	14.0 lbs.	J504

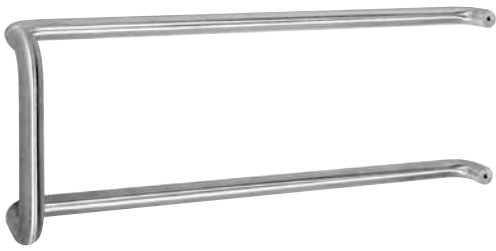

Series 47 Straight Double Bar Sets

Material: Aluminum, brass, bronze, stainless steel

Finishes: Available in standard architectural finishes, US32DMS, US32D316, US32316, white (WPC), red (RPC), and black (BPC) powder coat finishes (see page 9).

Mounting:	Door	Push Free End	Common End	Description	Mounting Spec. No.
	Metal & wood	1	5	Back to back & thru bolt	T3**
	Metal	6	5	Back to back & concealed	T4
	Wood	8	5	Back to back & concealed	T5
	Metal & wood	12	5	Back to back & decorative bolt	T1
	Glass	15	13	Back to back & thru bolt	T2

**T3 is the standard mounting method for metal and wood doors.

NOTE: See page A10 for detailed mounting drawings.

Ordering: Specify product number, mounting, door type, push bar CTC, and finish (11247-2 T3, wood door, 33" CTC, US32D316)

Other: See page A1 on "How To" size push bars

Options:

- Engraving "PUSH" or "PULL". Specify handing
- Base plates available similar to those shown on page A12 — use BP prefix (BP11047-2) when ordering
- Heavy duty versions of most fastening types available — use suffix HD to fastening type number (11047-2 T3HD)

NOTE: Pull bar Projection : 3-1/2" for Stainless Steel and 3" for Aluminum

No.	Material Size	Pull			Push		Weight	ANSI 156.6
		CTC	Projection	Clearance	Projection	Clearance		
11047-2	1" dia.	8"	3"	2"	2 ³ / ₄ "	1 ³ / ₄ "	20.0 lbs.	J504
111A47-2	1" dia.	9"	3"	2"	2 ³ / ₄ "	1 ³ / ₄ "	20.2 lbs.	J504
11147-2	1" dia.	10"	3"	2"	2 ³ / ₄ "	1 ³ / ₄ "	20.5 lbs.	J504
11247-2	1" dia.	12"	3"	2"	2 ³ / ₄ "	1 ³ / ₄ "	21.0 lbs.	J504

ASSA ABLOY
Opening Solutions

Experience a safer
and more open world

800-458-2424 | www.assaabloydooraccessories.us

Check the web site for the up-to-date catalog

Copyright © 2012-2020, ASSA ABLOY Accessories and Door Controls Group, Inc. All rights reserved. Reproduction in whole or in part without the express written permission of ASSA ABLOY Accessories and Door Controls Group, Inc. is prohibited.



Series 47 Straight Triple Bar Sets

Material: Aluminum, brass, bronze, stainless steel

Finishes: Available in standard architectural finishes, US32DMS, US32D316, US32316, white (WPC), red (RPC), and black (BPC) powder coat finishes (see page 9).

Mounting:	Door	Push Free End	Common End	Description	Mounting Spec. No.
	Metal & wood	1	5	Back to back & thru bolt	T3**
	Metal	6	5	Back to back & concealed	T4
	Wood	8	5	Back to back & concealed	T5
	Metal & wood	12	5	Back to back & decorative bolt	T1
	Glass	15	13	Back to back & thru bolt	T2

**T3 is the standard mounting method for metal and wood doors.

NOTE: See page A10 for detailed mounting drawings

Ordering: Specify product number, mounting, door type, push bar CTC, and finish (11247-3 T3, wood door, 33" CTC, US32D316)

Other: See page A1 on "How To" size push bars

Options:

- Engraving "PUSH" or "PULL". Specify handing
- Base plates available similar to those shown on page A12 — use BP prefix (BP11047-3) when ordering
- Heavy duty versions of most fastening types available — use suffix HD to fastening type number (11047-3 T3HD)

NOTE: Pull bar Projection : 3-1/2" for Stainless Steel and 3" for Aluminum

No.	Material Size	Pull			Push		Weight	ANSI 156.6
		CTC	Projection	Clearance	Projection	Clearance		
11047-3	1" dia.	8"	3"	2"	2 ³ / ₄ "	1 ³ / ₄ "	28.5 lbs.	J504
111A47-3	1" dia.	9"	3"	2"	2 ³ / ₄ "	1 ³ / ₄ "	28.7 lbs.	J504
11147-3	1" dia.	10"	3"	2"	2 ³ / ₄ "	1 ³ / ₄ "	29.0 lbs.	J504
11247-3	1" dia.	12"	3"	2"	2 ³ / ₄ "	1 ³ / ₄ "	29.5 lbs.	J504



Series 47 Offset Single Bar Sets

Material: Brass, bronze, stainless steel

Finishes: Available in standard architectural finishes, US32DMS, US32D316, US32316, white (WPC), red (RPC), and black (BPC) powder coat finishes (see page 9).

Mounting:	Door	Pull Free End	Push Free End	Common End	Description	Mounting Spec. No.
	Metal & wood	1	1	5	Back to back & thru bolt	T3**
	Metal	17	6	16	Back to back & concealed	T4
	Wood	8	8	5	Back to back & concealed	T5
	Metal & wood	12	12	5	Back to back & decorative bolt	T1
	Glass	15	15	13	Back to back & thru bolt	T2

** T3 is the standard mounting method for metal and wood doors.

NOTE: See page A10 for detailed mounting drawings

Ordering: Specify product number, mounting, door type, push bar CTC, and finish (BF15747 T3, wood door, 33" CTC, US32D316)

Other: See page A1 on "How To" size push bars

Options:

- Engraving "PUSH" or "PULL". Specify handing
- Base plates available similar to those shown on page A12 — use BP prefix (BPBF15747) when ordering
- Heavy duty versions of most fastening types available — use suffix HD to fastening type number (BF15647 T3HD)

No.	Material Size	Pull			Push		Weight	ANSI 156.6
		CTC	Projection	Clearance	Projection	Clearance		
BF15647	1" dia.	8"	3½"	2½"	2¾"	1¾"	12.4 lbs.	J505
BF157A47	1" dia.	9"	3½"	2½"	2¾"	1¾"	12.6 lbs.	J505
BF15747	1" dia.	10"	3½"	2½"	2¾"	1¾"	12.8 lbs.	J505
BF15847	1" dia.	12"	3½"	2½"	2¾"	1¾"	13.3 lbs.	J505
BF15947	1" dia.	18"	3½"	2½"	2¾"	1¾"	15.0 lbs.	J505

ASSA ABLOY
Opening Solutions

Experience a safer
and more open world

800-458-2424 | www.assaabloydooraccessories.us

Check the web site for the up-to-date catalog

Copyright © 2012-2020, ASSA ABLOY Accessories and Door Controls Group, Inc. All rights reserved. Reproduction in whole or in part without the express written permission of ASSA ABLOY Accessories and Door Controls Group, Inc. is prohibited.

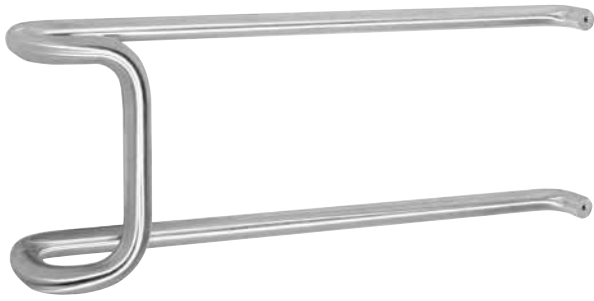

Series 47 Offset Double Bar Sets

Material: Aluminum, brass, bronze, stainless steel

Finishes: Available in standard architectural finishes, US32DMS, US32D316, US32316, white (WPC), red (RPC), and black (BPC) powder coat finishes (see page 9).

Mounting:	Door	Push Free End	Common End	Description	Mounting Spec. No.
	Metal & wood	1	5	Back to back & thru bolt	T3**
	Metal	6	16	Back to back & concealed	T4
	Wood	8	5	Back to back & concealed	T5
	Metal & wood	12	5	Back to back & decorative bolt	T1
	Glass	15	13	Back to back & thru bolt	T2

** T3 is the standard mounting method for metal and wood doors.

NOTE: See page A10 for detailed mounting drawings

Ordering: Specify product number, mounting, door type, push bar CTC, and finish (BF15747-2 T3, wood door, 33" CTC, US32D316)

Other: See page A1 on "How To" size push bars

Options:

- Engraving "PUSH" or "PULL". Specify handing
- Base plates available similar to those shown on page A12 — use BP prefix (BPBF15747-2) when ordering
- Heavy duty versions of most fastening types available — use suffix HD to fastening type number (BF15647-2 T3HD)

No.	Material Size	Pull			Push		Weight	ANSI 156.6
		CTC	Projection	Clearance	Projection	Clearance		
BF15647-2	1" dia.	8"	3 1/2"	2 1/2"	2 3/4"	1 3/4"	20.9 lbs.	J505
BF157A47-2	1" dia.	9"	3 1/2"	2 1/2"	2 3/4"	1 3/4"	21.1 lbs.	J505
BF15747-2	1" dia.	10"	3 1/2"	2 1/2"	2 3/4"	1 3/4"	21.3 lbs.	J505
BF15847-2	1" dia.	12"	3 1/2"	2 1/2"	2 3/4"	1 3/4"	21.8 lbs.	J505

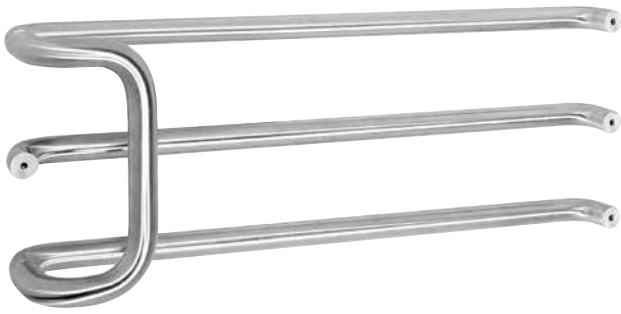

Series 47 Offset Triple Bar Sets

Material: Aluminum, brass, bronze, stainless steel

Finishes: Available in standard architectural finishes, US32DMS, US32D316, US32316, white (WPC), red (RPC), and black (BPC) powder coat finishes (see page 9).

Mounting:	Door	Push Free End	Common End	Description	Mounting Spec. No.
	Metal & wood	1	5	Back to back & thru bolt	T3**
	Metal	6	16	Back to back & concealed	T4
	Wood	8	5	Back to back & concealed	T5
	Metal & wood	12	5	Back to back & decorative bolt	T1
	Glass	15	13	Back to back & thru bolt	T2

** T3 is the standard mounting method for metal and wood doors.

NOTE: See page A10 for detailed mounting drawings

Ordering: Specify product number, mounting, door type, push bar CTC, and finish (BF15747-3 T3, wood door, 33" CTC, US32D316)

Other: See page A1 on "How To" size push bars

Options:

- Engraving "PUSH" or "PULL". Specify handing
- Base plates available similar to those shown on page A12 — use BP prefix (BPBF15747-3) when ordering
- Heavy duty versions of most fastening types available — use suffix HD to fastening type number (BF15647-3 T3HD)

No.	Material Size	Pull			Push		Weight	ANSI 156.6
		CTC	Projection	Clearance	Projection	Clearance		
BF15647-3	1" dia.	8"	3 1/2"	2 1/2"	2 3/4"	1 3/4"	29.4 lbs.	J505
BF157A47-3	1" dia.	9"	3 1/2"	2 1/2"	2 3/4"	1 3/4"	29.6 lbs.	J505
BF15747-3	1" dia.	10"	3 1/2"	2 1/2"	2 3/4"	1 3/4"	29.8 lbs.	J505
BF15847-3	1" dia.	12"	3 1/2"	2 1/2"	2 3/4"	1 3/4"	30.3 lbs.	J505

ASSA ABLOY
Opening Solutions

Experience a safer
and more open world

800-458-2424 | www.assaabloydooraccessories.us

Check the web site for the up-to-date catalog

Copyright © 2012-2020, ASSA ABLOY Accessories and Door Controls Group, Inc. All rights reserved. Reproduction in whole or in part without the express written permission of ASSA ABLOY Accessories and Door Controls Group, Inc. is prohibited.

T Series 1" Tubular Push Bars and Push & Pull Bar Sets

The Rockwood T Series 1" diameter tubular push and pull bar sets are made from sturdy .065" thick wall tubing. Solid brass or stainless steel inserts are brazed into the ends to provide a solid area for our guaranteed mounting systems.

Benefits of specifying the T Series push and pulls include:

- Tubular pulls weigh 25% less than their solid counterparts; this 75% weight reduction greatly reduces the environmental impact of harvesting material for their manufacture – a LEED certified building goal
- The lighter weight minimizes the risk of damage in shipping and handling
- The cost of most tubular pulls represents a significant savings over the equivalent solid model

Considering all the benefits, the T Series pulls offer an improved value without any quality sacrifice.

T Series is also available in straight pulls (see page B15) and offset pulls (see page B29).

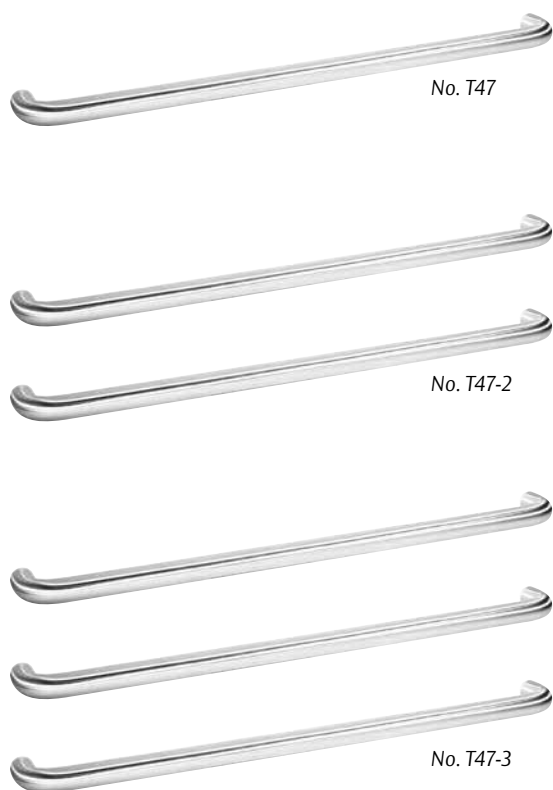

T47 Series Tubular Push Bars No. T47, T47-2, T47-3

Material: Brass, bronze, stainless steel

Finishes: Available in standard architectural finishes (see page 9)

Mounting: Metal and wood door: type 1, $\frac{1}{4}$ " - 20 x $2\frac{1}{4}$ " thru bolt and finish washer (standard $1\frac{3}{4}$ " door)
Metal door: type 6, concealed, $\frac{1}{4}$ " - 20 CH MS
NOTE: See page A10 for detailed mounting drawings

Ordering: Specify CTC, door type, mounting, and finish (Specify Handing)

Options:

- Engraving "PUSH" or "PULL"
- Advise if door thickness is other than $1\frac{3}{4}$ "

PUSH

Engraved

No.	CTC	Material Size	Base	Projection	Clearance	Weight	ANSI 156.6
T47	Specify	1" dia.	1" dia.	$2\frac{3}{4}$ "	$1\frac{3}{4}$ "	2.9 lbs.	J501
T47-2	Specify	1" dia.	1" dia.	$2\frac{3}{4}$ "	$1\frac{3}{4}$ "	5.8 lbs.	J501
T47-3	Specify	1" dia.	1" dia.	$2\frac{3}{4}$ "	$1\frac{3}{4}$ "	8.7 lbs.	J501



T47 Series Straight Tubular Single Bar Sets

Material: Brass, bronze, stainless steel

Finishes: Available in standard architectural finishes (see page 9)

Mounting:	Door	Pull Free End	Push Free End	Common End	Description	Mounting Spec. No.
	Metal & wood	1	1	5	Back to back & thru bolt	T3**
	Metal	6	6	5	Back to back & concealed	T4
	Wood	8	8	5	Back to back & concealed	T5
	Metal & wood	12	12	5	Back to back & decorative bolt	T1
	Glass	15	15	13	Back to back & thru bolt	T2

**T3 is the standard mounting method for metal and wood doors.

NOTE: See page A10 for detailed mounting drawings

Ordering: Specify product number, mounting, door type, push bar CTC, and finish (T11247 T3, wood door, 33" CTC, US32D)

Other: See page A1 on "How To" size push bars

Options:

- Engraving "PUSH" or "PULL". Specify handing
- Base plates available similar to those shown on page A12 — use BP prefix (TBP11047) when ordering

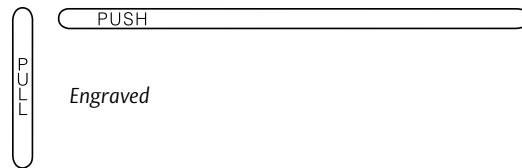

No.	Material Size	CTC	Pull		Push		Weight	ANSI 156.6
			Projection	Clearance	Projection	Clearance		
T11047	1" dia.	8"	3"	2"	2 ³ / ₄ "	1 ³ / ₄ "	3.9 lbs.	J504
T111A47	1" dia.	9"	3"	2"	2 ³ / ₄ "	1 ³ / ₄ "	4.0 lbs.	J504
T11147	1" dia.	10"	3"	2"	2 ³ / ₄ "	1 ³ / ₄ "	4.0 lbs.	J504
T11247	1" dia.	12"	3"	2"	2 ³ / ₄ "	1 ³ / ₄ "	4.1 lbs.	J504
T11847	1" dia.	18"	3"	2"	2 ³ / ₄ "	1 ³ / ₄ "	4.6 lbs.	J504

ASSA ABLOY
Opening Solutions

Experience a safer
and more open world

800-458-2424 | www.assaabloydooraccessories.us
Check the web site for the up-to-date catalog

Copyright © 2012-2020, ASSA ABLOY Accessories and Door Controls Group, Inc. All rights reserved. Reproduction in whole or in part without the express written permission of ASSA ABLOY Accessories and Door Controls Group, Inc. is prohibited.



TBF47 Series Offset Tubular Single Bar Sets

Material: Brass, bronze, stainless steel

Finishes: Available in standard architectural finishes (see page 9)

Mounting:	Door	Pull Free End	Push Free End	Common End	Description	Mounting Spec. No.
	Metal & wood	1	1	5	Back to back & thru bolt	T3**
	Metal	17	6	16	Back to back & concealed	T4
	Wood	8	8	5	Back to back & concealed	T5
	Metal & wood	12	12	5	Back to back & decorative bolt	T1
	Glass	15	15	13	Back to back & thru bolt	T2

**T3 is the standard mounting method for metal and wood doors.

NOTE: See page A10 for detailed mounting drawings

Ordering: Specify product number, mounting, door type, push bar CTC, and finish (TBF15747 T3, wood door, 33" CTC, US32D)

Other: See page A1 on "How To" size push bars

Options:

- Engraving "PUSH" or "PULL". Specify handing
- Base plates available similar to those shown on page A12 — use BP prefix (TBF15747) when ordering

No.	Material Size	Pull			Push		Weight	ANSI 156.6
		CTC	Projection	Clearance	Projection	Clearance		
TBF15647	1" dia.	8"	3 1/2"	2 1/2"	2 3/4"	1 3/4"	4.2 lbs.	J504
TBF157A47	1" dia.	9"	3 1/2"	2 1/2"	2 3/4"	1 3/4"	4.3 lbs.	J504
TBF15747	1" dia.	10"	3 1/2"	2 1/2"	2 3/4"	1 3/4"	4.3 lbs.	J504
TBF15847	1" dia.	12"	3 1/2"	2 1/2"	2 3/4"	1 3/4"	4.4 lbs.	J504
TBF15947	1" dia.	18"	3 1/2"	2 1/2"	2 3/4"	1 3/4"	4.9 lbs.	J504

Location Standards

Positioning Applications:

- Door pulls to plates
- Cutouts on plates
- Engraving on plates
- Cutout and engraving on plates

NOTE: Be sure the pull you choose will fit on the plate, allowing for cutouts and/or engraving

Sizing:

- 1 1/4" standard cylinder hole cutout size
- 3/8" diameter standard turn knob hole
- Other cutout sizes and styles are readily available

Engraving:

- 1" high condensed block letters with black enamel fill
- Other letter sizes and styles are readily available

ADA Accessibility Guidelines for Buildings and Facilities (ADAAG)

As amended through 2004

4.13.9 Door Hardware. Handles, pulls, latches, locks, and other operating devices on accessible doors shall have a shape that is easy to grasp with one hand and does not require tight grasping, tight pinching, or twisting of the wrist to operate. Lever-operated mechanisms, push-type mechanisms, and U-shaped handles are acceptable designs. When sliding doors are fully open, operating hardware shall be exposed and usable from both sides. Hardware required for accessible door passage shall be mounted no higher than 48" (1220 mm) above finished floor.

Pull Positioning on Plates 4" or Less in Width

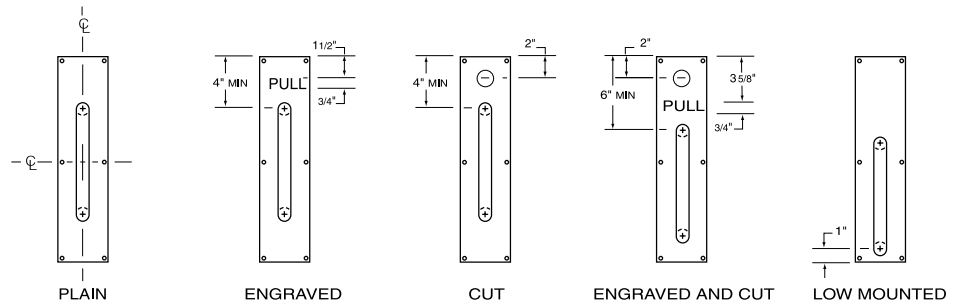

Pull Positioning on Plates Wider than 4" (Handing Required)

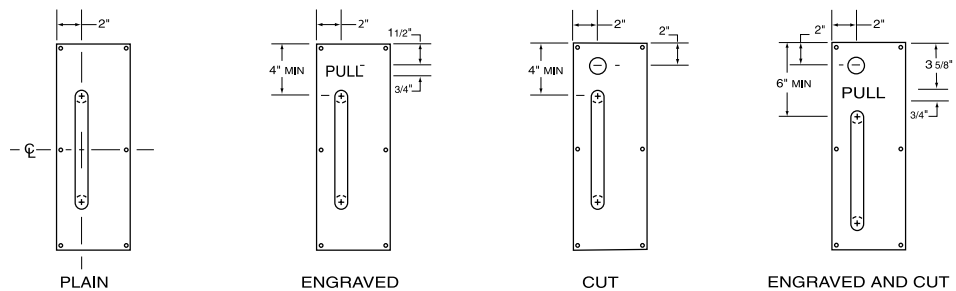

Recommended Locations on Door

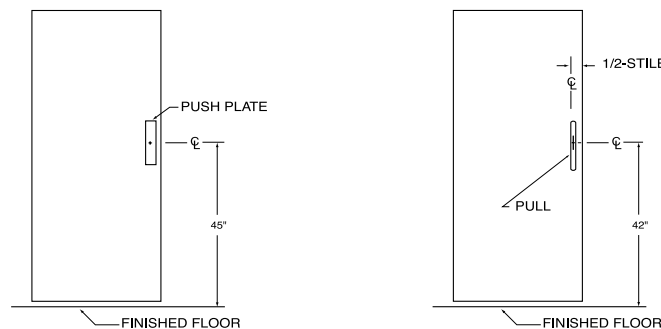

800-458-2424 | www.assaabloydooraccessories.us

Check the web site for the up-to-date catalog

Copyright © 2012-2020, ASSA ABLOY Accessories and Door Controls Group, Inc. All rights reserved. Reproduction in whole or in part without the express written permission of ASSA ABLOY Accessories and Door Controls Group, Inc. is prohibited.

ASSA ABLOY
Opening Solutions

Experience a safer
and more open world

Push Plates – .050" Thick

Material: Aluminum, brass, bronze, stainless steel

Finishes: Available in standard architectural finishes, US32DMS, and US32D316 (see page 9)

Fastener: #6 x 5/8" OH SMS

Features: Four beveled edges

Ordering: Specify plate number followed by size designation and finish (70B US32D) or for non-standard size 70 Specify width x height and finish. Specify any additional options

- Options:**
- Custom sizes available upon request
 - TEK – self-drilling screws
 - TORX – security Torx screws
 - SA – self-adhesive mounting: 1/16" double face foam tape (no screw holes on plate)
 - Engraving on plates 4" wide or wider. Specify copy. See page B1 for standard engraving locations
 - Cylinder cutouts (CFC) and turn knob cutouts (CFTT). See page B1 for standard locations and sizes
 - Heavy bevel available on 70A to 70G, specify HVBEV



No. 70

No.	Standard Size	Weight	ANSI A156.6
70A	3" x 12"	0.7 lbs.	J301
70B	3 1/2" x 15"	0.9 lbs.	J301
70C-RKW	4" x 16"	.85 lbs..	J301
70E	6" x 16"	1.5 lbs.	J301
70F	8" x 16"	2.0 lbs.	J301
70G	4" x 20"	1.3 lbs.	J301



No. 70RC

No.	Standard Size	Weight	ANSI A156.6
70RCA	3" x 12"	0.7 lbs.	J301
70RCB	3 1/2" x 15"	0.9 lbs.	J301
70RCC	4" x 16"	1.0 lbs.	J301
70RCE	6" x 16"	1.5 lbs.	J301
70RCF	8" x 16"	2.0 lbs.	J301
70RCG	4" x 20"	1.3 lbs.	J301



No. 70RE

No.	Standard Size	Weight	ANSI A156.6
70REA	3" x 12"	0.7 lbs.	J301
70REB	3 1/2" x 15"	0.9 lbs.	J301
70REC	4" x 16"	1.0 lbs.	J301
HG70C	4" x 16"	.85 lbs.	

ASSA ABLOY
Opening Solutions

Experience a safer
and more open world

800-458-2424 | www.assaabloydooraccessories.us
Check the web site for the up-to-date catalog

Copyright © 2012-2020, ASSA ABLOY Accessories and Door Controls Group, Inc. All rights reserved. Reproduction in whole or in part without the express written permission of ASSA ABLOY Accessories and Door Controls Group, Inc. is prohibited.

Push Plates – .062" Thick

Material: Stainless steel

Finishes: Available in standard architectural finishes (see page 9)

Fastener: #6 x ⁵/₁₆" OH SMS

Features: Four beveled edges

Ordering: Specify plate number followed by size designation and finish (71B US32D) or for non-standard size 71 Specify width x height and finish. Specify any additional options

- Options:**
- Custom sizes available upon request
 - TEK – self-drilling screws
 - TORX – security Torx screws
 - SA – self-adhesive mounting: ¹/₁₆" double face foam tape (no screw holes on plate)
 - Engraving on plates 4" wide or wider. Specify copy. See page B1 for standard engraving locations
 - Cylinder cutouts (CFC) and turn knob cutouts (CFTT). See page B1 for standard locations and sizes



No. 71

No.	Standard Size	Weight	ANSI A156.6
71A	3" x 12"	0.9 lbs.	J301
71B	3½" x 15"	1.1 lbs.	J301
71C	4" x 16"	1.2 lbs.	J301
71E	6" x 16"	1.8 lbs.	J301
71F	8" x 16"	2.4 lbs.	J301
71G	4" x 20"	1.5 lbs.	J301



No. 71RC

No.	Standard Size	Weight	ANSI A156.6
71RCA	3" x 12"	0.9 lbs.	J301
71RCB	3½" x 15"	1.1 lbs.	J301
71RCC	4" x 16"	1.2 lbs.	J301
71RCE	6" x 16"	1.8 lbs.	J301
71RCF	8" x 16"	2.4 lbs.	J301
71RCG	4" x 20"	1.5 lbs.	J301



No. 71RE

No.	Standard Size	Weight	ANSI A156.6
71REA	3" x 12"	0.9 lbs.	J301
71REB	3½" x 15"	1.1 lbs.	J301
71REC	4" x 16"	1.2 lbs.	J301

Push Plates – .125" Thick

Material: Aluminum, brass, bronze, stainless steel

Finishes: Available in standard architectural finishes, and US32D316 (see page 9)

Fastener: #6 x 5/8" OH SMS

Features: Four beveled edges

Ordering: Specify plate number followed by size designation and finish (73B US32D) or for non-standard size 73 Specify width x height and finish. Specify any additional options

- Options:**
- Custom sizes available upon request
 - TEK – self-drilling screws
 - TORX – security Torx screws
 - SA – self-adhesive mounting: 1/16" double face foam tape (no screw holes on plate)
 - Engraving on plates 4" wide or wider. Specify copy. See page B1 for standard engraving locations
 - Cylinder cutouts (CFC) and turn knob cutouts (CFTT). See page B1 for standard locations and sizes



No. 73

No.	Standard Size	Weight	ANSI A156.6
73A	3" x 12"	1.7 lbs.	J304
73B	3 1/2" x 15"	2.1 lbs.	J304
73C	4" x 16"	2.5 lbs.	J304
73E	6" x 16"	3.8 lbs.	J304
73F	8" x 16"	5.0 lbs.	J304
73G	4" x 20"	3.2 lbs.	J304



No. 73RC

No.	Standard Size	Weight	ANSI A156.6
73RCA	3" x 12"	1.7 lbs.	J304
73RCB	3 1/2" x 15"	2.1 lbs.	J304
73RCC	4" x 16"	2.5 lbs.	J304
73RCE	6" x 16"	3.8 lbs.	J304
73RCF	8" x 16"	5.0 lbs.	J304
73RCG	4" x 20"	3.2 lbs.	J304



No. 73RE

No.	Standard Size	Weight	ANSI A156.6
73REA	3" x 12"	1.7 lbs.	J304
73REB	3 1/2" x 15"	2.1 lbs.	J304
73REC	4" x 16"	2.5 lbs.	J304

ASSA ABLOY
Opening Solutions

Experience a safer
and more open world

800-458-2424 | www.assaabloydooraccessories.us
Check the web site for the up-to-date catalog

Copyright © 2012-2020, ASSA ABLOY Accessories and Door Controls Group, Inc. All rights reserved. Reproduction in whole or in part without the express written permission of ASSA ABLOY Accessories and Door Controls Group, Inc. is prohibited.

Push Plates – .125" Thick No. 75

- Material:** Plastic laminate, clear plastic, Kydex®
- Colors:** Black, brown, gray, beige, white, and clear
- Fastener:** #6 x 5/8 OH SMS
- Features:** Four beveled edges
- Ordering:** Specify color and any other options
- Options:**
- Custom sizes available upon request
 - SA – Self-adhesive mounting: 1/16" double face foam tape (no screw holes on plate). Not available on clear plastic
 - Engraving on plates 4" wide or wider. Specify copy. See page B1 for standard engraving locations
 - Cylinder cutouts (CFC) and turn knob cutouts (CFTT). See page B1 for standard locations and sizes



No.	Standard Size	Weight	ANSI
75A	3" x 12"	0.3 lbs.	J304
75B	3 1/2" x 15"	0.4 lbs.	J304
75C	4" x 16"	0.5 lbs.	J304
75E	6" x 16"	0.7 lbs.	J304
75F	8" x 16"	0.9 lbs.	J304
75G	4" x 20"	0.6 lbs.	J304

® Kydex is a registered trademark of Kleerdex Company.



No. 76



No. 77

Decorative Push Plates – .050" Thick No. 76, 77

Material: Brass, bronze

Finishes: Available in standard architectural finishes (see page 9)

Fastener: #6 x 5/8" OH SMS

Ordering: Specify finish

Options: These plates look great when combined with the No. 147 or 148 pulls as shown on page B22

No.	Standard Size	Weight	ANSI
76B	3 1/2" x 15"	0.9 lbs.	J301
76C	4" x 16"	1.0 lbs.	J301
77B	3 1/2" x 15"	0.9 lbs.	J301
77C	4" x 16"	1.0 lbs.	J301



Push Plates – .050" Thick No. 80, 81, 82

Material: Aluminum, brass, bronze, stainless steel

Finishes: Available in standard architectural finishes, US32DMS, and US32D316 (see page 9)

Fastener: #6 x 5/8" OH SMS

Ordering: Specify finish

Options:

- Plates may be mated with most any door pull of your choice
- Custom sizes available upon request

No.	Standard Size	Weight	ANSI
80	6" x 12"	1.4 lbs.	J301
81	7 1/2" x 15"	1.6 lbs.	J301
82	8" x 16"	1.8 lbs.	J301



Push Plate – .050" Thick No. 84

Material: Aluminum, brass, bronze, stainless steel

Finishes: Available in standard architectural finishes, US32DMS, and US32D316 (see page 9)

Fastener: #6 x 5/8" OH SMS

Ordering: Specify finish and handing (right handing shown)

Options:

- Variations of design can be created to fit your requests
- Plate may be mated with most any door pull of your choice

No.	Standard Size	Weight	ANSI
84	10" x 20"	2.1 lbs.	J301

ASSA ABLOY
Opening Solutions

Experience a safer
and more open world

800-458-2424 | www.assaabloydooraccessories.us

Check the web site for the up-to-date catalog

Copyright © 2012-2020, ASSA ABLOY Accessories and Door Controls Group, Inc. All rights reserved. Reproduction in whole or in part without the express written permission of ASSA ABLOY Accessories and Door Controls Group, Inc. is prohibited.



Push Plates – .050" Thick No. 85, 86

- Material:** Aluminum, brass, bronze, stainless steel
- Finishes:** Available in standard architectural finishes, and US32DMS (see page 9)
- Fastener:** #6 x 5/8" OH SMS
- Features:** Cold forged to 7/32" thick
- Ordering:** Specify finish
- Options:** Plates may be mated with most any door pull of your choice

No.	Standard Size	Weight	ANSI
85	3 1/2" x 15"	0.9 lbs.	J302
86	4" x 16"	1.0 lbs.	J302



Push Plate – .125" Thick No. 87

- Material:** Aluminum, brass, bronze, stainless steel
- Finishes:** Available in standard architectural finishes (see page 9)
- Fastener:** #6 x 5/8" OH SMS
- Ordering:** Specify finish
- Options:**
- Variations of design can be created to fit your requests
 - Plate may be mated with most any door pull of your choice

No.	Standard Size	Weight	ANSI
87	2 5/8" x 16"	2.0 lbs.	J304



Heavy Duty Security Flush Pull No. D89

- Material:** Cast brass
- Finishes:** Available in US4, US10BE and US26D (see page 9)
- Fastener:** 1/4-20 x 1/2" OH Security Torx MS
#14 x 1" OH Security Torx SMS

No.	Size	Grip Opening	Depth	Weight	ANSI A156.6
D89	4"x5"	1 3/4"x3 1/2"	7/8"	1.3 lbs.	J403



Cylinder Pulls No. 90, 90B

- Material:** .125" aluminum, brass, bronze, stainless steel
- Finishes:** Available in standard architectural finishes, and US32DMS (see page 9)
- Fastener:** #8 x 3/4" OH SMS
- Options:** No cylinder hole — screw mounted, order No. 90B

No.	Size	Opening	Projection	Weight	ANSI A156.6
90	2" x 3 3/4"	1 1/4" dia.	1"	0.3 lbs.	J303
90B	2" x 3 3/4"	—	1"	0.3 lbs.	J303



Combination Push Pull Plates No. 91-RKW, 92-RKW, 93-RKW

- Material:** .125" aluminum, brass, bronze, stainless steel
- Finishes:** Available in standard architectural finishes, and US32DMS (see page 9)
- Fastener:** #8 x 7/8" SMS
- Options:**
- TORX – security Torx screws
 - Cylinder cutouts (CFC) and turn knob cutouts (CFTT). See page B1 for standard locations and sizes

No.	Size	Projection	Weight	ANSI A156.6
91-RKW	3 1/2" x 15 3/4"	1"	1.9 lbs.	J303
92-RKW	4" x 15 3/4"	1"	2.2 lbs.	J303
93-RKW	8" x 15 3/4"	1"	4.4 lbs.	J303



Flush Pulls No. 94, 94BTB

- Material:** .125" brass, bronze, stainless steel
- Finishes:** Available in standard architectural finishes, US32DMS, US32D316, and US32316 (see page 9)
NOTE: Cups are painted black on all finishes except stainless steel.
- Fastener:** No. 94: #8 x 3/4" SMS
No. 94BTB: #8 - 32 x 3/4" OH MS with sleeves Type 10
- Options:** TORX – security Torx screws

No.	Size	Grip Opening	Depth	Weight	ANSI A156.6
94	3 1/2" x 5"	1 3/4" x 3 1/8"	7/8"	0.6 lbs.	J403
94BTB (pair)	3 1/2" x 5"	1 3/4" x 3 1/8"	1 3/4"	1.2 lbs.	J403



Flush Pull No. 94C

- Material:** .125" brass, bronze, stainless steel
- Finishes:** Available in standard architectural finishes, US32DMS, US32D316, and US32316 (see page 9)
NOTE: Cups are painted black on all finishes except stainless steel
- Fastener:** #6 x 1" TH SMS.
- Features:**
- Fasteners concealed in cup.
 - Accepted by the New York State Office of Mental Health (OMH) for use in high risk areas

No.	Size	Grip Opening	Depth	Weight	ANSI A156.6
94C	3 1/2" x 5"	1 3/4" x 3 1/8"	7/8"	0.6 lbs.	J403



Dead Lock Flush Pulls No. 94DLL, 94DLS

- Material:** .125" brass, bronze, stainless steel
- Finishes:** Available in standard architectural finishes, US32DMS, US32D316, and US32316 (see page 9)
NOTE: Cups are painted black on all finishes except stainless steel
- Fastener:** #8 x 3/4" OH SMS.
- Features:**
- Used with dead bolt lock. 1 1/4" cylinder hole is standard
 - Vandal resistant.
 - Use where projecting trim is an operational problem or an aesthetic objection
 - Ideal for use on "exit only" doors where occasional entrance is required (warehouse exits), night latch function exit device openings (classroom exit only doors), mechanical closet doors and anywhere dead locking is approved
- Options:**
- TORX – security Torx screws
 - Custom sizes

No.	Size	Grip Opening	Depth	Weight	ANSI A156.6
94DLL	6 1/8" x 8"	1 3/4" x 6 1/8"	7/8"	1.0 lbs.	J403
94DLS	6 1/8" x 5"	1 3/4" x 3 1/8"	7/8"	0.8 lbs.	J403



Flush Pull No. 94L

- Material:** .125" brass, bronze, stainless steel
- Finishes:** Available in standard architectural finishes, US32DMS, US32D316, and US32316 (see page 9)
NOTE: Cups are painted black on all finishes except stainless steel
- Fastener:** 1/4" - 20 x 1 1/2" thru bolt & finish washer (standard 1 3/4" door)
- Features:** Includes lugs for thru bolt. No fasteners on pull side
- Options:**
- TORX – security Torx screws
 - Advise if door thickness other than 1 3/4"

No.	Size	Grip Opening	Depth	Weight	ANSI A156.6
94L	3 1/2" x 5"	1 3/4" x 3 1/8"	7/8"	0.6 lbs.	J403



Flush Pull No. 94P

- Material:** .125" brass, bronze, stainless steel
- Finishes:** Available in standard architectural finishes, US32DMS, US32D316, and US32316 (see page 9)
NOTE: Cups are painted black on all finishes except stainless steel
- Fastener:** 1/4" - 20 x 1 1/2" MS
- Features:** Usually used with the 94L as a set (see below)
- Options:** TORX - security Torx screws

No.	Size	Grip Opening	Depth	Weight	ANSI A156.6
94P	3 1/2" x 5"	1 3/4" x 3 1/8"	7/8"	0.6 lbs.	J403

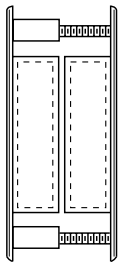

Flush Pull Set No. 94P x 94L

- Material:** .125" brass, bronze, stainless steel
- Finishes:** Available in standard architectural finishes, US32DMS, US32D316, and US32316 (see page 9)
NOTE: Cups are painted black on all finishes except stainless steel
- Fastener:** 1/4" - 20 x 1 1/2" thru bolt (standard 1 3/4" door)
- Options:**
- TORX – security Torx screws
 - Advise if door thickness other than 1 3/4"

No.	Size	Weight	ANSI A156.6
94P x 94L	Set consists of 1 94L and 1 94P	1.3 lbs.	J403

ASSA ABLOY
Opening Solutions

Experience a safer
and more open world

800-458-2424 | www.assaabloydooraccessories.us
Check the web site for the up-to-date catalog

Copyright © 2012-2020, ASSA ABLOY Accessories and Door Controls Group, Inc. All rights reserved. Reproduction in whole or in part without the express written permission of ASSA ABLOY Accessories and Door Controls Group, Inc. is prohibited.



Flush Pull No. 95A

- Material:** Cast brass
Finishes: Available in standard architectural finishes (see page 9)
Fastener: #6 x $\frac{5}{8}$ " SMS
Features: Fasteners concealed in cup

No.	Size	Grip Opening	Depth	Weight	ANSI A156.6
95A	2 $\frac{3}{16}$ " x 3 $\frac{1}{4}$ "	$\frac{7}{8}$ " x 2 $\frac{7}{16}$ "	$\frac{3}{4}$ "	0.6 lbs.	J403



Flush Pull No. 95B

- Material:** Cast brass
Finishes: Available in standard architectural finishes (see page 9)
Fastener: #8 x $\frac{7}{8}$ " SMS
Features: Fasteners concealed in cup

No.	Size	Grip Opening	Depth	Weight	ANSI A156.6
95B	2 $\frac{11}{16}$ " x 4 $\frac{3}{16}$ "	1 $\frac{7}{16}$ " x 3 $\frac{1}{2}$ "	$\frac{3}{4}$ "	0.8 lbs.	J403



Flush Pull No. 95R

- Material:** Cast brass
Finishes: Available in standard architectural finishes (see page 9)
Fastener: #8 x $\frac{7}{8}$ " SMS
Features: Fasteners concealed in cup

No.	Size	Grip Opening	Depth	Weight	ANSI A156.6
95R	3 $\frac{1}{2}$ " dia.	2 $\frac{3}{4}$ " x 1 $\frac{11}{16}$ "	$\frac{7}{8}$ "	0.6 lbs.	J403



Flush Pull No. 96

Material: .125" aluminum, brass, bronze, stainless steel

Finishes: Available in standard architectural finishes (see page 9)

Fastener: #8 x 3/4" FH SMS

Options:

- TORX – security Torx screws
- Special sizes
- Cylinder cutouts (CFC) and turn knob cutouts (CTFF). See page B1 for standard locations and sizes

No.	Size	Grip Opening	Depth	Weight	ANSI A156.6
96	4" x 16"	1 7/8" x 3 1/8"	7/8"	2.2 lbs.	J403



No. BF97

Barrier Free Flush Pulls No. BF97, BF97L

Material: .125" brass, bronze, stainless steel

Finishes: Available in standard architectural finishes, and US32DMS (see page 9).

Fastener: No. BF97: #8 x 3/4" FH SMS
No. BF97L: #8 - 32 stud welded lugs and #8 - 32 FH MS

Options: TORX – security Torx screws

Features: ADA flush pull

No.	Size	Grip Opening	Depth	Weight	ANSI A156.6
BF97	5" x 5"	2 1/2" x 3 1/2"	7/8"	1.0 lbs.	J403
BF97L	5" x 5"	2 1/2" x 3 1/2"	7/8"	1.0 lbs.	J403



No. BF97L

ASSA ABLOY
Opening Solutions

Experience a safer
and more open world

800-458-2424 | www.assaabloydooraccessories.us
Check the web site for the up-to-date catalog

Copyright © 2012-2020, ASSA ABLOY Accessories and Door Controls Group, Inc. All rights reserved. Reproduction in whole or in part without the express written permission of ASSA ABLOY Accessories and Door Controls Group, Inc. is prohibited.

Thru Bolt

Wood or Metal Door – Type 1

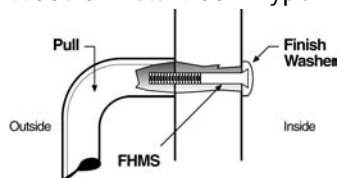

Type	Bolt Size	Drill Size	
		Wood	Metal
1	1/4 - 20	9/32	9/32
1HD	5/16 - 18	11/32	11/32
1XHD	3/8 - 16	13/32	13/32

Wood or Metal Door – Type 12

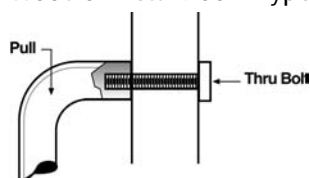

Type	Bolt Size	Drill Size	
		Wood	Metal
12	1/4 - 20	9/32	9/32
12HD	5/16 - 18	11/32	11/32
12XHD	3/8 - 16	13/32	13/32

Glass Door – Type 15

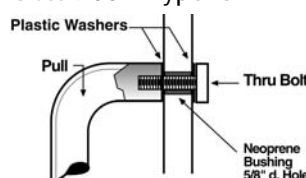

Type	Bolt Size	Drill Size
		Glass
15	1/4 - 20	5/8
15HD	5/16 - 18	5/8
15XHD	3/8 - 16	5/8

NOTE: Heavy Duty (HD/XHD) mounting features hex drive for positive tightening and large overall size for superior strength. Recommended for high frequency and rough service openings.

Back to Back

Wood or Metal Door – Type 5

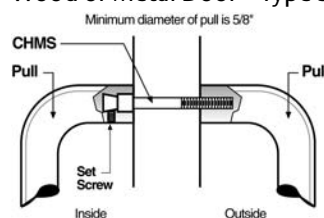

Type	Bolt Size	Drill Size	
		Wood	Metal
5	1/4 - 20	9/32	9/32
5HD	5/16 - 18	11/32	11/32

Any Door Type – Type 9

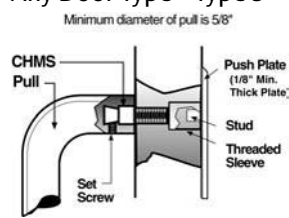

Type	Bolt Size	Drill Size
		Metal
9	1/4 - 20	N/A

Glass Door – Type 13

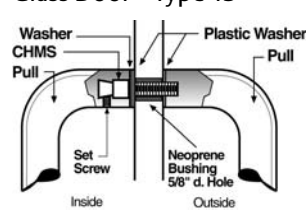

Type	Bolt Size	Drill Size
		Glass
13	1/4 - 20	5/8
13HD	5/16 - 18	5/8

Surface Concealed

Metal Door – Type 6

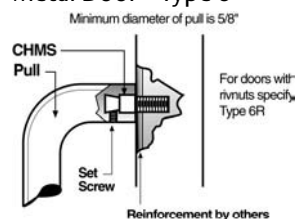

Type	Bolt Size	Drill Size
		Metal
6	1/4 - 20	1/4 - 20 tap
6HD	5/16 - 18	5/16 - 18 tap

Metal Door – Type 6R

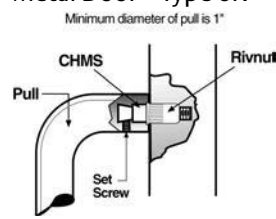

Type	Bolt Size	Drill Size
		Metal
6R	1/4 - 20	N/A

Wood Door – Type 8

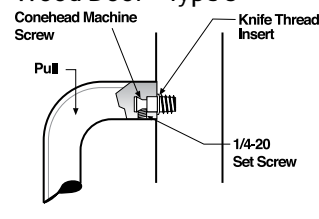

Type	Bolt Size	Drill Size
		Wood
8	1/4 - 20	23/64 X 9/16 dp
8HD	5/16 - 18	7/16 X 9/16 dp

Flush Pull Mounting

Type 10 Mounting applies to the 94 Series Flush Pulls

Wood or Metal Door – Type 10

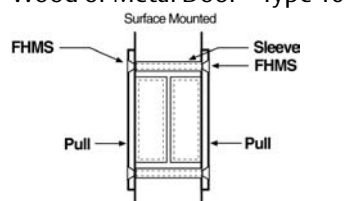

Type	Bolt Size	Drill Size	
		Wood	Metal
10	8 - 32	9/32	9/32

Wire or Small PostMount Pull Mounting

NOTE: This mounting should only be used on pulls with mounting points that are 1/2\"/>

Wood or Metal Door – Type 55

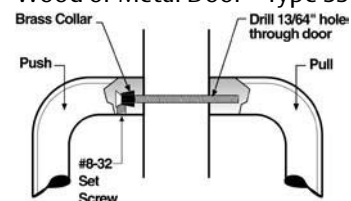

Type	Bolt Size	Drill Size	
		Wood	Metal
55	8 - 32	13/64	13/64



Door Pulls No. 102-RKW, 105, 106-RKW, 107, 108, 109

Material: Aluminum, brass, bronze, stainless steel

Finishes: Available in standard architectural finishes, US32DMS, US32D316, US32316, white (WPC), red (RPC), and black (BPC) powder coat finishes (see page 9)

Fastener: 1/4-20 x 2 1/4" thru bolt & finish washer (standard 1 3/4" door)

- Options:**
- Back to back mounting in pairs — use BTB suffix and mounting type number (107BTB5)
 - Concealed mounting single pulls — use C suffix and mounting type number (107C6)
 - Advise if door thickness is other than 1 3/4"
 - See page B13 for mounting selection (standard duty 1/4-20)
 - 2 1/2" Barrier Free clearance — use BF prefix (BF107)

No.	Material Size	CTC	Overall	Base	Projection	Clearance	Weight	ANSI A156.6
102-RKW	5/8" dia.	5 1/2"	6 1/8"	5/8"	2 1/8"	1 1/2"	0.6 lbs.	—
105	3/4" dia.	5 1/2"	6 1/4"	3/4"	2 5/8"	1 7/8"	1.2 lbs.	J401
106-RKW	3/4" dia.	6"	6 3/4"	3/4"	2 5/8"	1 7/8"	1.3 lbs.	J401
107	3/4" dia.	8"	8 3/4"	3/4"	2 5/8"	1 7/8"	1.6 lbs.	J401
108	3/4" dia.	10"	10 3/4"	3/4"	2 5/8"	1 7/8"	1.8 lbs.	J401
109	3/4" dia.	12"	12 3/4"	3/4"	2 5/8"	1 7/8"	2.1 lbs.	J401



Door Pulls No. 110-RKW, 111A, 111, 112, 118

Material: Aluminum, brass, bronze, stainless steel

Finishes: Available in standard architectural finishes, US32DMS, US32D316, US32316, white (WPC), red (RPC), and black (BPC) powder coat finishes (see page 9)

Fastener: 1/4-20 x 2 1/4" thru bolt & finish washer (standard 1 3/4" door)

- Options:**
- Back to back mounting in pairs — use BTB suffix and mounting type number (112BTB5)
 - Concealed mounting single pulls — use C suffix and mounting type number (112C6)
 - Advise if door thickness is other than 1 3/4"
 - Heavy duty versions of most fastening types available — use suffix HD to fastening type number (112BTB5HD)
 - See page B13 for mounting selection (standard duty 1/4-20)
 - 2 1/2" Barrier Free clearance — use BF prefix (BF110)

No.	Material Size	CTC	Overall	Base	Projection	Clearance	Weight	ANSI A156.6
110-RKW	1" dia.	8"	9"	1"	3"	2"	3.0 lbs.	J401
111A	1" dia.	9"	10"	1"	3"	2"	3.3 lbs.	J401
111	1" dia.	10"	11"	1"	3"	2"	3.5 lbs.	J401
112*	1" dia.	12"	13"	1"	3"	2"	4.0 lbs.	J401
118	1" dia.	18"	19"	1"	3"	2"	5.4 lbs.	J401

ASSA ABLOY
Opening Solutions

Experience a safer
and more open world

800-458-2424 | www.assaabloydooraccessories.us

Check the web site for the up-to-date catalog

Copyright © 2012-2020, ASSA ABLOY Accessories and Door Controls Group, Inc. All rights reserved. Reproduction in whole or in part without the express written permission of ASSA ABLOY Accessories and Door Controls Group, Inc. is prohibited.

T Series 1" Tubular Pulls

Rockwood T Series 1" diameter straight tubular pulls are made from sturdy .065" thick wall tubing. Solid brass or stainless steel inserts are brazed into the ends to provide a solid area for our guaranteed mounting systems.

Benefits of specifying the T Series push and pulls include:

- Tubular pulls weigh 25% less than their solid counterparts; this 75% weight reduction greatly reduces the environmental impact of harvesting material for their manufacture – a LEED certified building goal
- The lighter weight minimizes the risk of damage in shipping and handling
- The cost of most tubular pulls represents a significant savings over the equivalent solid model

Considering all the benefits, the T Series pulls offer an improved value without any quality sacrifice.

T Series is also available in offset pulls (see page B29) and in both Series 47 push bars and push & pull bar sets (see pages A19-A21).



Tubular Door Pulls No. T110, T111A, T111, T112, T118

Material: Brass, bronze, stainless steel

Finishes: Available in standard architectural finishes (see page 9)

Fastener: 1/4"-20 x 2 1/4" thru bolt & finish washer (standard 1 3/4" door)

Options:

- Back to back mounting in pairs — use BTB suffix and mounting type number (T112BTB5)
- Concealed mounting single pulls — use C suffix and mounting type number (T112C6)
- Advise if door thickness is other than 1 3/4"
- See page B13 for mounting selection (standard duty 1/4" - 20)
- 2 1/2" Barrier Free clearance — use BF prefix (TBF110)

No.	Material Size	CTC	Overall	Base	Projection	Clearance	Weight	ANSI A156.6
T110	1" dia.	8"	9"	1"	3"	2"	1.0 lbs.	—
T111A	1" dia.	9"	10"	1"	3"	2"	1.1 lbs.	J401
T111	1" dia.	10"	11"	1"	3"	2"	1.1 lbs.	J401
T112	1" dia.	12"	13"	1"	3"	2"	1.2 lbs.	J401
T118	1" dia.	18"	19"	1"	3"	2"	1.7 lbs.	J401



Concealed Mount Pull Plate Sets

No. 107 x 73B/73BL, 110 x 73C/73CL, 111 x 73C/73CL

- Material:** Stainless steel
- Finishes:** US32D
- Fastener:** Type 9. Stud welded lugs on the back of the push plate are permanently attached to the 1/8" thick push plate. Cone head MS attached to selected door pull
- Features:**
- This set has no perimeter screw holes in either plate
 - Concealed mounting system. Any of the rod type door pulls from No. 105 to No. 118 are appropriate for this application
- Options:**
- Engraving on plates 4" wide or wider. Specify copy. See page B1 for standard engraving locations
 - Cylinder cutouts (CFC) and turn knob cutouts (CFTT). See page B1 for standard locations and sizes
 - *Other overall sizes available upon request

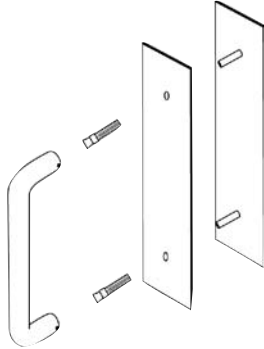

No.	Pull	Pull Size	Pull CTC	Pull Plate	Push Plate	Overall*	Weight	ANSI A156.6
107 x 73B/73BL	107	3/4" dia.	8"	73B	73BL	3 1/2" x 15"	5.8 lbs.	J406
110 x 73C/73CL	110	1" dia.	8"	73C	73CL	4" x 16"	8.0 lbs.	J406
111 x 73C/73CL	111	1" dia.	10"	73C	73CL	4" x 16"	8.5 lbs.	J406

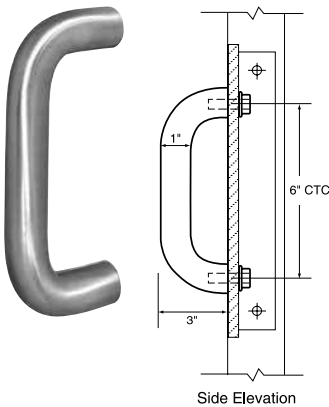

Security Door Pull No. 110-6SP

- Material:** Stainless steel
- Finishes:** US32D, US32DMS, US10BE
- Fastener:** 3/8" - 16 hex head MS with nylon patch
- Features:** For use on security hollow metal doors with reinforcing plate and access hole cover plate with TORX - security Torx screws — all to be supplied by door manufacturer

No.	Material Size	CTC	Overall	Base	Projection	Clearance	Weight	ANSI A156.6
110-6SP	1" dia.	6"	7"	1"	3"	2"	2.4 lbs.	J401

ASSA ABLOY
Opening Solutions

Experience a safer
and more open world

800-458-2424 | www.assaabloydooraccessories.us
Check the web site for the up-to-date catalog

Copyright © 2012-2020, ASSA ABLOY Accessories and Door Controls Group, Inc. All rights reserved. Reproduction in whole or in part without the express written permission of ASSA ABLOY Accessories and Door Controls Group, Inc. is prohibited.



Door Pulls with Base Plates No. Y102, Y105, Y106, Y107, Y108, Y109

- Material:** Aluminum, brass, bronze, stainless steel
- Finishes:** Available in standard architectural finishes, US32DMS, US32D316, US32316, white (WPC), red (RPC), and black (BPC) powder coat finishes (see page 9)
- Fastener:** 1/4-20x2 1/2" thru bolt & finish washer (standard 1 3/4" door)
- Features:** 1/8" base plates improve stability on the door. Recommended for glass and wood doors
- Options:**
- Back to back mounting in pairs — use BTB suffix and mounting type number (Y107BTB5)
 - Concealed mounting single pulls — use C suffix and mounting type number (Y107C6)
 - Advise if door thickness is other than 1 3/4"
 - See page B13 for mounting selection (standard duty 1/4-20)

No.	Material Size	CTC	Overall	Base	Projection	Clearance	Weight	ANSI A156.6
Y102	5/8" dia.	5 1/2"	6 1/8"	7/8"	2 1/8"	1 1/2"	0.6 lbs.	—
Y105	3/4" dia.	5 1/2"	6 7/8"	1 1/16"	2 3/8"	1 5/8"	1.2 lbs.	J401
Y106	3/4" dia.	6"	7 1/16"	1 1/16"	2 3/8"	1 5/8"	1.3 lbs.	J401
Y107	3/4" dia.	8"	9 1/16"	1 1/16"	2 3/8"	1 5/8"	1.6 lbs.	J401
Y108	3/4" dia.	10"	11 1/16"	1 1/16"	2 3/8"	1 5/8"	1.8 lbs.	J401
Y109	3/4" dia.	12"	13 1/16"	1 1/16"	2 3/8"	1 5/8"	2.1 lbs.	J401



Door Pulls with Base Plates No. Y110, Y111A, Y111, Y112, Y118

- Material:** Aluminum, brass, bronze, stainless steel
- Finishes:** Available in standard architectural finishes, US32DMS, US32D316, US32316, white (WPC), red (RPC), and black (BPC) powder coat finishes (see page 9)
- Fastener:** 1/4-20x2 1/2" thru bolt & finish washer (standard 1 3/4" door)
- Features:** 1/8" base plates improve stability on the door. Recommended for glass and wood doors.
- Options:**
- Back to back mounting in pairs — use BTB suffix and mounting type number (Y112BTB5)
 - Concealed mounting single pulls — use C suffix and mounting type number (Y112C6)
 - Advise if door thickness is other than 1 3/4"
 - Heavy duty versions of most fastening types available — use suffix HD to fastening type number (Y112BTB5HD)
 - See page B13 for mounting selection (standard duty 1/4-20)

No.	Material Size	CTC	Overall	Base	Projection	Clearance	Weight	ANSI A156.6
Y110	1" dia.	8"	9 1/4"	1 1/4"	3 1/8"	2 1/8"	3.1 lbs.	J401
Y111A	1" dia.	9"	10 1/4"	1 1/4"	3 1/8"	2 1/8"	3.4 lbs.	J401
Y111	1" dia.	10"	11 1/4"	1 1/4"	3 1/8"	2 1/8"	3.6 lbs.	J401
Y112	1" dia.	12"	13 1/4"	1 1/4"	3 1/8"	2 1/8"	4.1 lbs.	J401
Y118	1" dia.	18"	19 1/4"	1 1/4"	3 1/8"	2 1/8"	5.5 lbs.	J401



Door Pull No. 120

- Material:** Aluminum, brass, stainless steel
- Finishes:** Available in standard architectural finishes (see page 9)
- Fastener:** 1/4-20 x 2 1/4" thru bolt & finish washer (standard 1 3/4" door)
- Options:**
- Engraving available vertically
 - Back to back mounting
 - Advise if door thickness is other than 1 3/4"
 - See page B13 for mounting selection (standard duty 1/4-20)

No.	Material Size	CTC	Overall	Base	Projection	Clearance	Weight	ANSI A156.6
120	3/8" x 1 1/4"	8"	14"	1" dia.	1 7/8"	1 3/8"	2.6 lbs.	J401



Door Pull No. 121

- Material:** Aluminum, brass, stainless steel
- Finishes:** Available in standard architectural finishes (see page 9)
- Fastener:** 1/4-20 x 2 1/4" thru bolt & finish washer (standard 1 3/4" door)
- Options:**
- Engraving available vertically
 - Back to back mounting
 - Advise if door thickness is other than 1 3/4"
 - See page B13 for mounting selection (standard duty 1/4-20)

No.	Material Size	CTC	Overall	Base	Projection	Clearance	Weight	ANSI A156.6
121	3/8" x 1 1/4"	8"	14"	1" dia.	1 7/8"	1 3/8"	2.6 lbs.	J401



Door Pulls No. 122-RKW, 123

- Material:** Aluminum, brass, stainless steel
- Finishes:** Available in standard architectural finishes (see page 9)
- Fastener:** 1/4-20 x 2 1/4" thru bolt & finish washer (standard 1 3/4" door)
- Options:**
- Advise if door thickness is other than 1 3/4"
 - See page B13 for mounting selection (standard duty 1/4-20)

No.	Material Size	CTC	Overall	Projection	Clearance	Weight	ANSI A156.6
122-RKW	3/8" x 1 1/4"	6"	6 3/8"	2"	1 5/8"	1.1 lbs.	J401
123	3/8" x 1 1/4"	8"	8 3/8"	2"	1 5/8"	1.4 lbs.	J401

ASSA ABLOY
Opening Solutions

Experience a safer
and more open world

800-458-2424 | www.assaabloydooraccessories.us
Check the web site for the up-to-date catalog

Copyright © 2012-2020, ASSA ABLOY Accessories and Door Controls Group, Inc. All rights reserved. Reproduction in whole or in part without the express written permission of ASSA ABLOY Accessories and Door Controls Group, Inc. is prohibited.



Door Pulls No. 125-RKW, 126-RKW

- Material:** Aluminum, brass, bronze, stainless steel
- Finishes:** Available in standard architectural finishes (see page 9)
- Fastener:** 1/4-20 x 2 1/4" thru bolt & finish washer (standard 1 3/4" door)
- Options:**
- Advise if door thickness is other than 1 3/4"
 - See page B13 for mounting selection (standard duty 1 1/4-20)

No.	Material Size	CTC	Overall	Projection	Clearance	Weight	ANSI A156.6
125-RKW	1" half round	6"	6 1/2"	2"	1 1/2"	1.1 lbs.	J401
126-RKW	1" half round	8"	8 1/2"	2"	1 1/2"	1.4 lbs.	J401



Cast Door Pull No. 130-RKW

- Material:** Cast aluminum, brass, stainless steel
- Finishes:** Available in standard architectural finishes (see page 9)
- Fastener:** 1/4-20 x 2 1/4" thru bolt & finish washer (standard 1 3/4" door)
- Options:**
- Advise if door thickness is other than 1 3/4"
 - See page B13 for mounting selection (standard duty 1/4-20)

No.	CTC	Overall	Base	Projection	Clearance	Weight	ANSI A156.6
130-RKW	5 1/2"	7 1/2"	2"	2 1/4"	1 1/2"	1.1 lbs.	J401



Cast Door Pull No. 131-RKW

- Material:** Cast aluminum, brass, bronze, stainless steel
- Finishes:** Available in standard architectural finishes (see page 9)
- Fastener:** #8 x 3/4" OH SMS

No.	CTC	Overall	Base	Projection	Clearance	Weight	ANSI A156.6
131-RKW	—	7 1/2"	2"	2 1/4"	1 1/2"	1.1 lbs.	J401



Cast Door Pull No. 132-RKW

- Material:** Cast aluminum, brass, bronze, stainless steel
- Finishes:** Available in standard architectural finishes, and US32DMS (see page 9)
- Fastener:** $\frac{1}{4}$ -20 x $2\frac{1}{4}$ " thru bolt & finish washer (standard $1\frac{3}{4}$ " door)
- Options:**
- Advise if door thickness is other than $1\frac{3}{4}$ "
 - See page B13 for mounting selection (standard duty $\frac{1}{4}$ - 20)

No.	CTC	Overall	Base	Projection	Clearance	Weight	ANSI A156.6
132-RKW	5 $\frac{1}{2}$ "	6 $\frac{3}{8}$ "	$\frac{7}{8}$	1 $\frac{7}{8}$ "	1 $\frac{3}{8}$ "	0.8 lbs.	J401



Security Loop Door Pull No. D133-RKW

- Material:** Brass, stainless steel
- Finishes:** US4, US10BE, US32D, and US32DMS
- Fastener:** 2 ea. $\frac{3}{8}$ -16 x $\frac{5}{8}$ " OH Security Torx MS

No.	CTC	Overall	Base	Projection	Clearance	Weight	ANSI A156.6
D133-RKW	7 $\frac{3}{4}$ "	8 $\frac{3}{4}$ "	1 $\frac{3}{4}$ " x 1 $\frac{7}{8}$ "	2 $\frac{1}{4}$ "	1 $\frac{11}{16}$ "	1.1 lbs.	J401



Cast Door Pull No. 134-RKW

- Material:** Cast brass
- Finishes:** Available in standard architectural finishes (see page 9)
- Fastener:** $\frac{1}{4}$ -20 x $2\frac{1}{4}$ " thru bolt & finish washer (standard $1\frac{3}{4}$ " door)
- Options:**
- Advise if door thickness is other than $1\frac{3}{4}$ "
 - See page B13 for mounting selection (standard duty $\frac{1}{4}$ - 20)

No.	CTC	Overall	Base	Projection	Clearance	Weight	ANSI A156.6
134-RKW	7 $\frac{1}{2}$ "	8 $\frac{1}{2}$ "	1"	1 $\frac{7}{8}$ "	1 $\frac{3}{8}$ "	1.0 lbs.	J401



Cast Door Pull No. 137

- Material:** Cast brass, stainless steel
- Finishes:** Available in standard architectural finishes, and US32DMS (see page 9)
- Fastener:** 1/4 - 20 x 2 1/4" thru bolt & finish washer (standard 1 3/4" door)
- Options:**
- Advise if door thickness is other than 1 3/4"
 - See page B13 for mounting selection (standard duty 1/4 - 20)

No.	CTC	Overall	Base	Projection	Clearance	Weight	ANSI A156.6
137	5 1/2"	6"	5/8" x 1 1/4"	2"	1 1/2"	0.9 lbs.	J401



Cast Door Pull No. 137L

- Material:** Cast brass, bronze
- Finishes:** Available in standard architectural finishes (see page 9)
- Fastener:** 1/4 - 20 x 2 1/4" thru bolt & finish washer (standard 1 3/4" door)
- Options:**
- Advise if door thickness is other than 1 3/4"
 - See page B13 for mounting selection (standard duty 1/4-20)

No.	CTC	Overall	Base	Projection	Clearance	Weight	ANSI A156.6
137L	10"	10 3/4"	5/8" x 1 1/4"	2 1/2"	1 3/4"	1.1 lbs.	J401



Cast Door Pull No. 138

- Material:** Cast aluminum, brass
- Finishes:** Available in standard architectural finishes (see page 9)
- Fastener:** 1/4 - 20 x 2 1/4" thru bolt & finish washer (standard 1 3/4" door)
- Options:**
- Advise if door thickness is other than 1 3/4"
 - See page B13 for mounting selection (standard duty 1/4 - 20)

No.	CTC	Overall	Base	Projection	Clearance	Weight	ANSI A156.6
138	7 1/2"	9 1/2"	2"	2"	1 1/2"	1.5 lbs.	J401



Cast Door Pull No. 139

- Material:** Cast aluminum, brass
- Finishes:** Available in standard architectural finishes (see page 9)
- Fastener:** #8 x 3/4" OH SMS

No.	CTC	Overall	Base	Projection	Clearance	Weight	ANSI A156.6
139	—	9 1/2"	2"	2"	1 1/2"	1.5 lbs.	J401



Door Pulls No. 147, 147L

- Material:** Cast brass.
- Finishes:** Available in standard architectural finishes (see page 9)
- Fastener:** 1/4 - 20 x 2 1/4" thru bolt & finish washer (standard 1 3/4" door)
- Options:** Elliptical base plates
- Options:**
- Advise if door thickness is other than 1 3/4"
 - See page B13 for mounting selection (standard duty 1/4 - 20)

No.	CTC	Overall	Base	Projection	Clearance	Weight	ANSI A156.6
147	6"	7 1/2"	1 1/8" dia.	2 1/2"	1 3/4"	1.2 lbs.	J401
147L	12"	13 3/4"	1 7/8" dia.	2 5/8"	1 7/8"	1.7 lbs.	J401



Door Pull No. 148

- Material:** Cast brass
- Finishes:** Available in standard architectural finishes (see page 9)
- Fastener:** 1/4 - 20 x 2 1/4" thru bolt & finish washer (standard 1 3/4" door)
- Options:**
- Type 5 back to back mounting.
 - Advise if door thickness is other than 1 3/4".
 - See page B13 for mounting selection (standard duty 1/4 - 20).

No.	CTC	Overall	Base	Projection	Clearance	Weight	ANSI
148	8"	8 7/8"	1 5/16"	2 1/4"	1 1/4"	1.5 lbs.	J401



Door Pull No. 149

- Material:** Cast brass
- Finishes:** Available in standard architectural finishes (see page 9)
- Fastener:** 1/4 - 20 x 2 3/4" thru bolt & finish washer (standard 1 3/4" door)
- Options:**
- Type 5 back to back mounting
 - Advise if door thickness is other than 1 3/4"
 - See page B13 for mounting selection (standard duty 1/4 - 20)

No.	CTC	Overall	Base	Projection	Clearance	Weight	ANSI
149	8"	9 3/4"	1 3/4"	2 5/8"	1 5/8"	1.8 lbs.	J401

ASSA ABLOY
Opening Solutions

Experience a safer
and more open world

800-458-2424 | www.assaabloydooraccessories.us
Check the web site for the up-to-date catalog

Copyright © 2012-2020, ASSA ABLOY Accessories and Door Controls Group, Inc. All rights reserved. Reproduction in whole or in part without the express written permission of ASSA ABLOY Accessories and Door Controls Group, Inc. is prohibited.



Pull Plates No. 102 x 70, 105 x 70, 106 x 70, 107 x 70

- Material:** Aluminum, brass, bronze, stainless steel
- Finishes:** Stocked in standard architectural finishes but available in any finish, US32DMS and US32D316 (see page 9)
- Fastener:** #6 x 5/8" OH SMS; 1/4-20 x 2 1/4" thru bolt & finish washer (standard 1 3/4" door)
- Options:**
- Barrier Free available in 2 1/2" clearance — use BF prefix when ordering (BF102 x 70C)
 - Advise if door thickness is other than 1 3/4"
 - See page B13 for mounting selection (standard duty 1/4-20)

No.	Pull	CTC	Plate	Size	Weight	ANSI A156.6
102 x 70B	5/8" dia.	5 1/2"	70	3 1/2" x 15"	1.8 lbs.	J405
102 x 70C	5/8" dia.	5 1/2"	70	4" x 16"	1.9 lbs.	J405
105 x 70B	3/4" dia.	5 1/2"	70	3 1/2" x 15"	2.1 lbs.	J405
105 x 70C	3/4" dia.	5 1/2"	70	4" x 16"	2.2 lbs.	J405
106 x 70B	3/4" dia.	6"	70	3 1/2" x 15"	2.2 lbs.	J405
106 x 70C	3/4" dia.	6"	70	4" x 16"	2.3 lbs.	J405
107 x 70B	3/4" dia.	8"	70	3 1/2" x 15"	2.4 lbs.	J405
107 x 70C	3/4" dia.	8"	70	4" x 16"	2.5 lbs.	J405



Pull Plates No. 110 x 70, 111 x 70

- Material:** Aluminum, brass, bronze, stainless steel
- Finishes:** Stocked in standard architectural finishes but available in any finish, US32DMS and US32D316 (see page 9)
- Fastener:** #6 x 5/8" OH SMS; 1/4-20 x 2 1/4" thru bolt & finish washer (standard 1 3/4" door)
- Options:**
- Barrier Free available in 2 1/2" clearance — use BF prefix when ordering (BF110 x 70C)
 - Advise if door thickness is other than 1 3/4"
 - See page B13 for mounting selection (standard duty 1/4-20)
 - Heavy bevel available, specify HVBEV

No.	Pull	CTC	Plate	Size	Weight	ANSI A156.6
110 x 70B	1" dia.	8"	70	3 1/2" x 15"	3.8 lbs.	J405
110 x 70C	1" dia.	8"	70	4" x 16"	3.9 lbs.	J405
111 x 70B	1" dia.	10"	70	3 1/2" x 15"	4.3 lbs.	J405
111 x 70C	1" dia.	10"	70	4" x 16"	4.4 lbs.	J405



Pull Plates No. 122 x 70, 123 x 70

- Material:** Aluminum, brass, stainless steel
- Finishes:** Stocked in standard architectural finishes but available in any finish (see page 9)
- Fastener:** #6 x 5/8" OH SMS; 1/4-20 x 2 1/4" thru bolt & finish washer (standard 1 3/4" door)
- Options:**
- Advise if door thickness is other than 1 3/4"
 - See page B13 for mounting selection (standard duty 1/4-20)
 - Heavy bevel available, specify HVBEV

No.	Pull	CTC	Plate	Size	Weight	ANSI A156.6
122 x 70B	3/8" x 1 1/4"	6"	70	3 1/2" x 15"	2.2 lbs.	J405
122 x 70C	3/8" x 1 1/4"	6"	70	4" x 16"	2.3 lbs.	J405
123 x 70B	3/8" x 1 1/4"	8"	70	3 1/2" x 15"	2.5 lbs.	J405
123 x 70C	3/8" x 1 1/4"	8"	70	4" x 16"	2.6 lbs.	J405



Pull Plates No. 125 x 70, 126 x 70

- Material:** Aluminum, brass, bronze, stainless steel
- Finishes:** Stocked in standard architectural finishes but available in any finish (see page 9)
- Fastener:** #6 x 5/8" OH SMS; 1/4-20 x 2 1/4" thru bolt & finish washer (standard 1 3/4" door)
- Options:**
- Advise if door thickness is other than 1 3/4"
 - See page B13 for mounting selection (standard duty 1/4-20)
 - Heavy bevel available, specify HVBEV

No.	Pull	CTC	Plate	Size	Weight	ANSI A156.6
125 x 70B	1" half round	6"	70	3 1/2" x 15"	2.0 lbs.	J405
125 x 70C	1" half round	6"	70	4" x 16"	2.1 lbs.	J405
126 x 70B	1" half round	8"	70	3 1/2" x 15"	2.3 lbs.	J405
126 x 70C	1" half round	8"	70	4" x 16"	2.4 lbs.	J405

ASSA ABLOY
Opening Solutions

Experience a safer
and more open world

800-458-2424 | www.assaabloydooraccessories.us
Check the web site for the up-to-date catalog

Copyright © 2012-2020, ASSA ABLOY Accessories and Door Controls Group, Inc. All rights reserved. Reproduction in whole or in part without the express written permission of ASSA ABLOY Accessories and Door Controls Group, Inc. is prohibited.

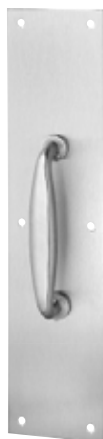

Pull Plates No. 132 x 70

- Material:** Aluminum, brass, bronze, stainless steel
- Finishes:** Stocked in standard architectural finishes but available in any finish, and US32DMS (see page 9)
- Fastener:** #6 x 5/8" OH SMS; 1/4" - 20 x 2 1/4" thru bolt & finish washer (standard 1 3/4" door)
- Options:**
- Advise if door thickness is other than 1 3/4"
 - See page B13 for mounting selection (standard duty 1/4" - 20)
 - Heavy bevel available, specify HVBEV

No.	Pull	CTC	Plate	Size	Weight	ANSI A156.6
132 x 70B	Cast	5 1/2"	70	3 1/2" x 15"	1.7 lbs.	J405
132 x 70C	Cast	5 1/2"	70	4" x 16"	1.8 lbs.	J405



Pull Plates No. 137 x 70

- Material:** Brass, stainless steel
- Finishes:** Stocked in standard architectural finishes but available in any finish (see page 9)
- Fastener:** #6 x 5/8" OH SMS; 1/4" - 20 x 2 1/4" thru bolt & finish washer (standard 1 3/4" door)
- Options:**
- Advise if door thickness is other than 1 3/4"
 - See page B13 for mounting selection (standard duty 1/4" - 20)
 - Heavy bevel available, specify HVBEV

No.	Pull	CTC	Plate	Size	Weight	ANSI A156.6
137 x 70B	Cast	5 1/2"	70	3 1/2" x 15"	1.7 lbs.	J405
137 x 70C	Cast	5 1/2"	70	4" x 16"	1.8 lbs.	J405



No. 147 x 76B



No. 147 x 77B

Pull Plates No. 147 x 76, 147 x 77

Material: Cast brass.

Finishes: Available in standard architectural finishes (see page 9)

Fastener: #6 x 5/8" OH SMS; 1/4-20 x 2 1/4" thru bolt & finish washer (standard 1 3/4" door)

Options:

- Advise if door thickness is other than 1 3/4"
- See page B13 for mounting selection (standard duty 1/4-20)

No.	Pull	CTC	Plate	Size	Weight	ANSI A156.6
147x76B	Cast	6"	76	3 1/2" x 15"	2.1 lbs.	J405
147x76C	Cast	6"	76	4" x 16"	2.2 lbs.	J405
147x77B	Cast	6"	77	3 1/2" x 15"	2.1 lbs.	J405
147x77C	Cast	6"	77	4" x 16"	2.2 lbs.	J405



No. 148 x 76B



No. 148 x 77B

Pull Plates No. 148 x 76, 148 x 77

Material: Cast brass

Finishes: Available in standard architectural finishes (see page 9)

Fastener: #6 x 5/8" OH SMS; 1/4-20 x 2 1/4" thru bolt & finish washer (standard 1 3/4" door)

Options:

- Advise if door thickness is other than 1 3/4"
- See page B13 for mounting selection (standard duty 1/4-20)

No.	Pull	CTC	Plate	Size	Weight	ANSI A156.6
148x76B	Cast	8"	76	3 1/2" x 15"	2.7 lbs.	J405
148x76C	Cast	8"	76	4" x 16"	2.8 lbs.	J405
148x77B	Cast	8"	77	3 1/2" x 15"	2.7 lbs.	J405
148x77C	Cast	8"	77	4" x 16"	2.8 lbs.	J405

ASSA ABLOY
Opening Solutions

Experience a safer
and more open world

800-458-2424 | www.assaabloydooraccessories.us
Check the web site for the up-to-date catalog

Copyright © 2012-2020, ASSA ABLOY Accessories and Door Controls Group, Inc. All rights reserved. Reproduction in whole or in part without the express written permission of ASSA ABLOY Accessories and Door Controls Group, Inc. is prohibited.

NOTE: Y base plates are recommended on wood or glass doors to make a stable and durable mounting.
 NOTE: Heavy Duty (HD/XHD) mounting features hex drive for positive tightening and large overall size for superior strength.
 Recommended for high frequency and rough service openings.

Thru Bolt

Wood or Metal Door - Type 1

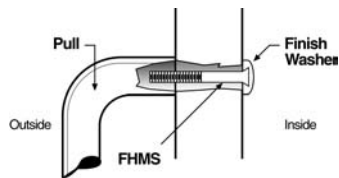

Type	Bolt Size	Drill Size	
		Wood	Metal
1	1/4 - 20	9/32	9/32
1HD	5/16 - 18	11/32	11/32
1XHD	3/8 - 16	13/32	13/32

Wood or Metal Door - Type 12

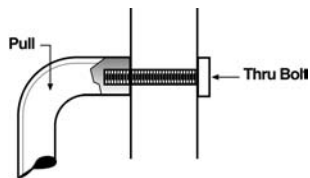

Type	Bolt Size	Drill Size	
		Wood	Metal
12	1/4 - 20	9/32	9/32
12HD	5/16 - 18	11/32	11/32
12XHD	3/8 - 16	13/32	13/32

Glass Door - Type 15

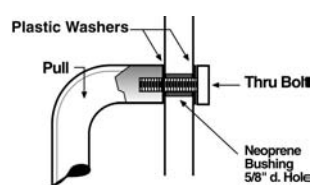

Type	Bolt Size	Drill Size
		Glass
15	1/4 - 20	5/8
15HD	5/16 - 18	5/8
15XHD	3/8 - 16	5/8

Back to Back

Wood or Metal Door - Type 16

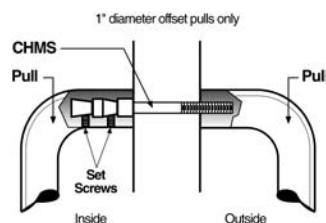

Type	Bolt Size	Drill Size	
		Wood	Metal
16	1/4 - 20	9/32	9/32
16HD	5/16 - 18	11/32	11/32

Glass Door - Type 18

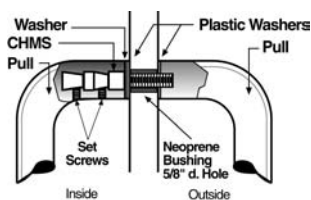

Type	Bolt Size	Drill Size
		Glass
18	1/4 - 20	5/8
18HD	5/16 - 18	5/8

Concealed

Metal Door - Type 17

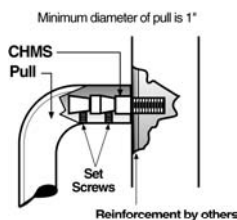

Type	Bolt Size	Drill Size
		Metal
17	1/4 - 20	1/4 - 20 tap
17HD	5/16 - 18	5/16 - 18 tap

Metal Door - Type 17R

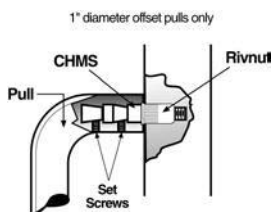

Type	Bolt Size	Drill Size
		Metal
17R	1/4 - 20	N/A

800-458-2424 | www.assaabloydooraccessories.us
 Check the web site for the up-to-date catalog

Copyright © 2012-2020, ASSA ABLOY Accessories and Door Controls Group, Inc. All rights reserved. Reproduction in whole or in part without the express written permission of ASSA ABLOY Accessories and Door Controls Group, Inc. is prohibited.

ASSA ABLOY
 Opening Solutions

Experience a safer
 and more open world

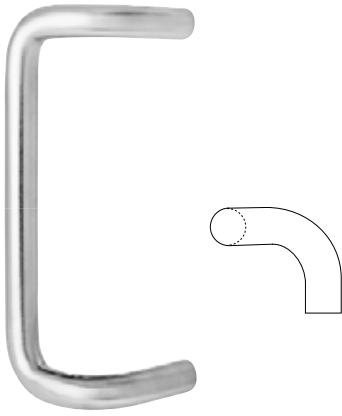

90° Offset Door Pulls No. BF150, BF151, BF152

Material: Aluminum, brass, bronze, stainless steel

Finishes: Available in standard architectural finishes, US32DMS, US32D316, US32316, white (WPC), red (RPC), and black (BPC) powder coat finishes (see page 9)

Fastener: 1/4-20 x 2 1/4" thru bolt & finish washer (standard 1 3/4" door)

- Options:**
- Back to back mounting in pairs — use BTB suffix and mounting type number (BF150BTB16)
 - Concealed mounting single pulls — use C suffix and mounting type number (BF150C17)
 - Advise if door thickness is other than 1 3/4"
 - See page B27 for mounting selection (standard duty 1/4-20)

No.	Material Size	CTC	Overall	Base	Projection	Clearance	Offset	Weight	ANSI A156.6
BF150	3/4" dia.	8"	8 3/4"	3/4"	3 1/4"	2 1/2"	3"	2.3 lbs.	J402
BF151	3/4" dia.	10"	10 3/4"	3/4"	3 1/4"	2 1/2"	3"	2.5 lbs.	J402
BF152	3/4" dia.	12"	12 3/4"	3/4"	3 1/4"	2 1/2"	3"	2.7 lbs	J402

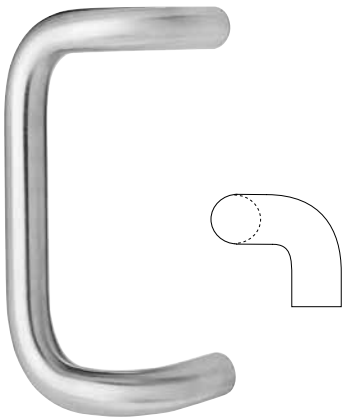

90° Offset Door Pulls No. BF156, BF157A, BF157, BF158, BF159

Material: Aluminum, brass, bronze, stainless steel

Finishes: Available in standard architectural finishes, US32DMS, US32D316, US32316, white (WPC), red (RPC), and black (BPC) powder coat finishes (see page 9)

Fastener: 1/4-20 x 2 1/4" thru bolt & finish washer (standard 1 3/4" door)

Features: Recommended for ADA openings

- Options:**
- Back to back mounting in pairs — use BTB suffix and mounting type number (BF156BTB16)
 - Concealed mounting single pulls — use C suffix and mounting type number (BF156C17)
 - Advise if door thickness is other than 1 3/4"
 - Heavy duty versions of most fastening types available — use suffix HD to fastening type number (BF156BTB16HD)
 - See page B27 for mounting selection (standard duty 1/4-20)

No.	Material Size	CTC	Overall	Base	Projection	Clearance	Offset	Weight	ANSI A156.6
BF156	1" dia.	8"	9"	1"	3 1/2"	2 1/2"	4"	3.9 lbs.	J402
BF157A	1" dia.	9"	10"	1"	3 1/2"	2 1/2"	4"	4.1 lbs.	J402
BF157	1" dia.	10"	11"	1"	3 1/2"	2 1/2"	4"	4.3 lbs.	J402
BF158	1" dia.	12"	13"	1"	3 1/2"	2 1/2"	4"	4.8 lbs.	J402
BF159	1" dia.	18"	19"	1"	3 1/2"	2 1/2"	4"	6.5 lbs.	J402

ASSA ABLOY
Opening Solutions

Experience a safer
and more open world

800-458-2424 | www.assaabloydooraccessories.us

Check the web site for the up-to-date catalog

Copyright © 2012-2020, ASSA ABLOY Accessories and Door Controls Group, Inc. All rights reserved. Reproduction in whole or in part without the express written permission of ASSA ABLOY Accessories and Door Controls Group, Inc. is prohibited.

T Series 1" Tubular Pulls

The Rockwood T Series diameter offset tubular pulls are made from sturdy .065" thick wall tubing. Solid brass or stainless steel inserts are brazed into the ends to provide a solid area for our guaranteed mounting systems.

Benefits of specifying the T Series push and pulls include:

- Tubular pulls weigh 25% less than their solid counterparts; this 75% weight reduction greatly reduces the environmental impact of harvesting material for their manufacture – a LEED certified building goal
- The lighter weight minimizes the risk of damage in shipping and handling
- The cost of most tubular pulls represents a significant savings over the equivalent solid model

Considering all the benefits, the T Series pulls offer an improved value without any quality sacrifice

T Series is also available in straight pulls (see page B15) and in both Series 47 push bars and push & pull bar sets (see pages A19-A21).

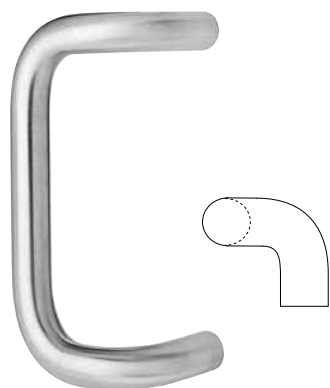

90° Offset Tubular Door Pulls

No. TBF156, TBF157A, TBF157, TBF158, TBF159

Material: Brass, bronze, stainless steel

Finishes: Available in standard architectural finishes (see page 9)

Fastener: 1/4"-20 x 2 1/4" thru bolt & finish washer (standard 1 3/4" door)

Features: Recommended for ADA openings

- Options:**
- Back to back mounting in pairs — use BTB suffix and mounting type number (TBF156BTB16)
 - Concealed mounting single pulls — use C suffix and mounting type number (TBF156C17)
 - Advise if door thickness is other than 1 3/4"
 - See page B27 for mounting selection (standard duty 1/4" - 20)

No.	Material Size	CTC	Overall	Base	Projection	Clearance	Offset	Weight	ANSI A156.6
TBF156	1" dia.	8"	9"	1"	3 1/2"	2 1/2"	4"	1.3 lbs.	J402
TBF157A	1" dia.	9"	10"	1"	3 1/2"	2 1/2"	4"	1.4 lbs.	J402
TBF157	1" dia.	10"	11"	1"	3 1/2"	2 1/2"	4"	1.4 lbs.	J402
TBF158	1" dia.	12"	13"	1"	3 1/2"	2 1/2"	4"	1.5 lbs.	J402
TBF159	1" dia.	18"	19"	1"	3 1/2"	2 1/2"	4"	2.0 lbs.	J402

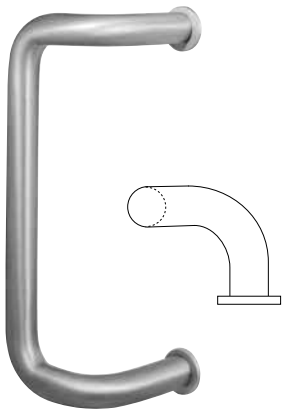

90° Offset Door Pulls with Base Plates

No. YBF150, YBF151, YBF152

- Material:** Aluminum, brass, bronze, stainless steel
- Finishes:** Available in standard architectural finishes, US32DMS, US32D316, US32316, white (WPC), red (RPC), and black (BPC) powder coat finishes (see page 9)
- Fastener:** 1/4 - 20 x 2 1/2" thru bolt & finish washer (standard 1 3/4" door)
- Features:** Base plates improve stability on all doors and are especially recommended for use on wood and glass doors
- Options:**
- Back to back mounting in pairs — use BTB suffix and mounting type number (YBF150BTB16)
 - Concealed mounting single pulls — use C suffix and mounting type number (YBF150C17)
 - Advise if door thickness is other than 1 3/4"
 - See page B27 for mounting selection (standard duty 1/4 - 20)

No.	Material Size	CTC	Overall	Base	Projection	Clearance	Offset	Weight	ANSI A156.6
YBF150	3/4" dia.	8"	9 1/16"	1 1/16"	3 3/4"	2 5/8"	3"	2.4 lbs.	J402
YBF151	3/4" dia.	10"	11 1/16"	1 1/16"	3 3/4"	2 5/8"	3"	2.6 lbs.	J402
YBF152	3/4" dia.	12"	13 1/16"	1 1/16"	3 3/4"	2 5/8"	3"	2.8 lbs	J402

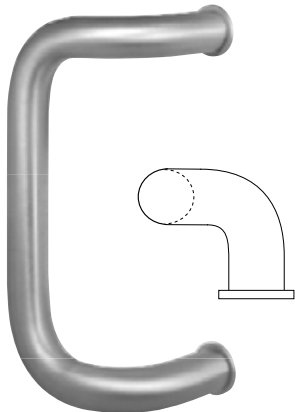

90° Offset Door Pulls with Base Plates

No. YBF156, YBF157A, YBF157, YBF158, YBF159

- Material:** Aluminum, brass, bronze, stainless steel.
- Finishes:** Available in standard architectural finishes, US32DMS, US32D316, US32316, white (WPC), red (RPC), and black (BPC) powder coat finishes (see page 9)
- Fastener:** 1/4 - 20 x 2 1/2" thru bolt & finish washer (standard 1 3/4" door)
- Features:**
- Recommended for ADA openings
 - Base plates improve stability on all doors and are especially recommended for use on wood and glass doors
- Options:**
- Back to back mounting in pairs — use BTB suffix and mounting type number (YBF156BTB16)
 - Concealed mounting single pulls — use C suffix and mounting type number (YBF156C17)
 - Advise if door thickness is other than 1 3/4"
 - Heavy duty versions of most fastening types available — use suffix HD to fastening type number (YBF156BTB16HD)
 - See page B27 for mounting selection (standard duty 1/4 - 20)

No.	Material Size	CTC	Overall	Base	Projection	Clearance	Offset	Weight	ANSI A156.6
YBF156	1" dia.	8"	9 1/4"	1 1/4"	3 5/8"	2 5/8"	4"	4.0 lbs.	J402
YBF157A	1" dia.	9"	10 1/4"	1 1/4"	3 5/8"	2 5/8"	4"	4.2 lbs.	J402
YBF157	1" dia.	10"	11 1/4"	1 1/4"	3 5/8"	2 5/8"	4"	4.4 lbs.	J402
YBF158	1" dia.	12"	13 1/4"	1 1/4"	3 5/8"	2 5/8"	4"	4.9 lbs.	J402
YBF159	1" dia.	18"	19 1/4"	1 1/4"	3 5/8"	2 5/8"	4"	6.6 lbs.	J402

ASSA ABLOY
Opening Solutions

Experience a safer
and more open world

800-458-2424 | www.assaabloydooraccessories.us
Check the web site for the up-to-date catalog

Copyright © 2012-2020, ASSA ABLOY Accessories and Door Controls Group, Inc. All rights reserved. Reproduction in whole or in part without the express written permission of ASSA ABLOY Accessories and Door Controls Group, Inc. is prohibited.

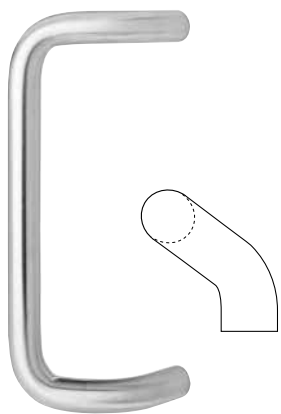

45° Offset Door Pulls No. BF160, BF161, BF162

Material: Aluminum, brass, bronze, stainless steel

Finishes: Available in standard architectural finishes, US32DMS, US32D316, US32316, white (WPC), red (RPC), and black (BPC) powder coat finishes (see page 9)

Fastener: 1/4 - 20 x 2 1/4" thru bolt & finish washer (standard 1 3/4" door)

Options:

- Back to back mounting in pairs — use BTB suffix and mounting type number (BF160BTB16)
- Concealed mounting single pulls — use C suffix and mounting type number (BF160C17)
- Advise if door thickness is other than 1 3/4"
- See page B27 for mounting selection (standard duty 1/4 - 20).
- Use Y prefix (YBF160) when ordering pulls with base plates, Y plate diameter is 1 1/16"; recommended for use on wood and glass doors

No.	Material Size	CTC	Overall	Base	Projection	Clearance	Offset	Weight	ANSI A156.6
BF160	3/4" dia.	8"	8 3/4"	3/4"	3 1/4"	2 1/2"	2 1/4"	1.8 lbs.	J402
BF161	3/4" dia.	10"	10 3/4"	3/4"	3 1/4"	2 1/2"	2 1/4"	2.0 lbs.	J402
BF162	3/4" dia.	12"	12 3/4"	3/4"	3 1/4"	2 1/2"	2 1/4"	2.2 lbs.	J402

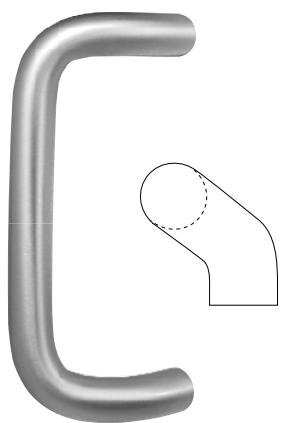

45° Offset Door Pulls

No. BF166, BF167A, BF167, BF168, BF169

Material: Aluminum, brass, bronze, stainless steel

Finishes: Available in standard architectural finishes, US32DMS, US32D316, US32316, white (WPC), red (RPC), and black (BPC) powder coat finishes (see page 9)

Fastener: 1/4 - 20 x 2 1/4" thru bolt & finish washer (standard 1 3/4" door)

Options:

- Back to back mounting in pairs — use BTB suffix and mounting type number (BF166BTB16)
- Concealed mounting single pulls — use C suffix and mounting type number (BF166C17)
- Advise if door thickness is other than 1 3/4"
- Heavy duty versions of most fastening types available — use suffix HD to fastening type number (BF166BTB16HD)
- See page B27 for mounting selection (standard duty 1/4 - 20)
- Use Y prefix (YBF16) when ordering pulls with base plates, Y plate diameter is 1 1/4"; recommended for use on wood and glass doors

No.	Material Size	CTC	Overall	Base	Projection	Clearance	Offset	Weight	ANSI A156.6
BF166	1" dia.	8"	9"	1"	3 1/2"	2 1/2"	2 3/4"	2.8 lbs.	J402
BF167A	1" dia.	9"	10"	1"	3 1/2"	2 1/2"	2 3/4"	3.0 lbs.	J402
BF167	1" dia.	10"	11"	1"	3 1/2"	2 1/2"	2 3/4"	3.2 lbs.	J402
BF168	1" dia.	12"	13"	1"	3 1/2"	2 1/2"	2 3/4"	3.6 lbs.	J402
BF169	1" dia.	18"	19"	1"	3 1/2"	2 1/2"	2 3/4"	5.0 lbs.	J402



Offset Door Pull No. 176-RKW

- Material:** Aluminum, brass, bronze, stainless steel
- Finishes:** Available in standard architectural finishes, except US26 and US26D (see page 9)
- Fastener:** 1/4" - 20 x 2 1/4" thru bolt & finish washer (standard 1 3/4" door)
- Options:**
- Engraving "PUSH" or "PULL" or a corporate logo. Email artwork file for quicker service
 - Advise if door thickness is other than 1 3/4"
 - See page B27 for mounting selection (standard duty 1/4" - 20)

No.	Material Size	CTC	Base	Projection	Clearance	Weight	ANSI A156.6
176-RKW	6" x 12"	10"	1 3/8" x 12"	2 1/4"	1 7/8"	6.8 lbs.	J409



Offset Door Pull No. 177

- Material:** Aluminum, brass, bronze, stainless steel
- Finishes:** Available in standard architectural finishes, except US26 and US26D (see page 9)
- Fastener:** 1/4" - 20 x 2 1/4" thru bolt & finish washer (standard 1 3/4" door)
- Options:**
- Engraving "PUSH" or "PULL" or a corporate logo. Email artwork file for quicker service
 - Advise if door thickness is other than 1 3/4"
 - See page B27 for mounting selection (standard duty 1/4" - 20)

No.	Material Size	CTC	Base	Projection	Clearance	Weight	ANSI A156.6
177	6" x 12"	10"	1 3/8" x 12"	2 1/4"	1 7/8"	3.3 lbs.	J409



Offset Door Pull No. 185

- Material:** Aluminum, brass, bronze, stainless steel
- Finishes:** Available in standard architectural finishes, except US26 and US26D (see page 9)
- Fastener:** 1/4" - 20 x 2 1/4" thru bolt & finish washer (standard 1 3/4" door)
- Options:**
- Engraving "PUSH" or "PULL" or a corporate logo. Email artwork file for quicker service
 - Advise if door thickness is other than 1 3/4"
 - See page B27 for mounting selection (standard duty 1/2" - 20)

No.	Material Size	CTC	Base	Projection	Clearance	Weight	ANSI A156.6
185	5" x 12"	10"	1" x 12"	2 3/8"	1 1/8"	12.5 lbs.	J409

ASSA ABLOY
Opening Solutions

Experience a safer
and more open world

800-458-2424 | www.assaabloydooraccessories.us
Check the web site for the up-to-date catalog

Copyright © 2012-2020, ASSA ABLOY Accessories and Door Controls Group, Inc. All rights reserved. Reproduction in whole or in part without the express written permission of ASSA ABLOY Accessories and Door Controls Group, Inc. is prohibited.



Wooden Door Pull No. 208

- Material:** Maple, oak, walnut, cherry (other woods available upon request)
- Finishes:** Brackets available in standard architectural finishes (see page 9)
Wood available in oiled or clear finish
- Fastener:** 1/4" - 20x2 1/4" thru bolt & finish washer (standard 1 3/4" door)
- Ordering:** Specify type of material, finish of wood, and finish of metal brackets
- Options:**
- Use Y prefix (Y208) when ordering pulls with base plates, Y plate diameter is 1 1/16"; recommended for use on glass or wood doors
 - Back to back mounting — use BTB suffix (208BTB) when ordering two pulls back to back. See page B27 for mounting details
 - Other sizes and shapes available; contact factory
 - Advise if door thickness is other than 1 3/4"

No.	Grip	CTC	Overall	Base	Projection	Clearance	Weight	ANSI A156.6
208	1"	8"	15"	3/4" dia.	2 1/2"	1 3/4"	1.9 lbs.	J401



Tapered Door Pulls No. 215, 215L

- Material:** Aluminum, brass, bronze, stainless steel.
- Finishes:** Available in standard architectural finishes, and US32DMS (see page 9)
- Fastener:** 1/4" - 20x2 1/4" thru bolt & finish washer (standard 1 3/4" door)
- Options:**
- Use Y prefix (Y215) when ordering pulls with base plates, Y plate diameter is 1 1/16"; recommended for use on glass or wood doors
 - Back to back mounting — use BTB suffix (215BTB) when ordering two pulls back to back. See page B27 for mounting details
 - Advise if door thickness is other than 1 3/4"

No.	Material Size	CTC	Overall	Base	Projection	Clearance	Weight	ANSI A156.6
215	1" dia.	8"	16"	3/4" dia.	2 1/2"	1 1/2"	3.5 lbs.	J401
215L	1 1/4" dia.	12"	28"	3/4" dia.	2 3/4"	1 1/2"	9.4 lbs.	J401



Arm Pull with Plate No. AP1007

- Material:** Stainless steel
- Finishes:** US32D, US32DMS, US10BE, BSP, WSP
- Fastener:** #8 x 3/4" OH SMS, 3/8-16 x 2 1/2" thru bolt & finish washer
- Features:** Groove on backside of pull to comfortably accept forearm.
Plate features rounded corners



No.	Pull	Projection	Clearance	Plate Size	Weight
AP1007	3/4" dia.	4"	2 ⁵ / ₃₂ " at center of groove	4" x 16"	4 lbs. 5.7 oz.



Arm Pulls No. AP1140, AP1141

- Material:** 1/8" Thick stainless steel
- Finishes:** US32DMS, US10BE, BSP, WSP
- Fasteners:** #10 x 1 1/4" FH SMS
- Options:** Apply above existing door pull or as new application



No.	Pull Width	Base Plate Width	Projection	Clearance	Weight
AP1140	1 1/2"	2"	4 1/2"	4 ³ / ₈ "	6.4 oz.
AP1141	1 1/2" to 3/4"	2"	4 1/2"	4 ³ / ₈ "	5 oz.



Hand/Arm Pull No. 193

- Material:** Cast brass, stainless steel
- Finishes:** US32D, US32DMS, US3, US4, US10, US10B, 10BE, BSP, WSP, US26, US26D
- Fasteners:** #8 x 3/4 OH SMS
- Options:** Use top portion as hand pull, use bottom portion as arm pull



No.	CTC	Overall	Projection	Clearance	Weight	ANSI A156.6
193	5 ¹⁵ / ₁₆ "	9 1/4"	3 3/4"	1 ⁵ / ₈ "	0.9 lbs.	J401

ASSA ABLOY
Opening Solutions

Experience a safer
and more open world

800-458-2424 | www.assaabloydooraccessories.us
Check the web site for the up-to-date catalog

Copyright © 2012-2020, ASSA ABLOY Accessories and Door Controls Group, Inc. All rights reserved. Reproduction in whole or in part without the express written permission of ASSA ABLOY Accessories and Door Controls Group, Inc. is prohibited.



Foot Pull No. FP1230

- Material:** $\frac{3}{16}$ " Thick stainless steel
- Finishes:** US32D, US32DMS, US10BE, BSP, WSP
- Fastener:** $\frac{1}{4}$ -20 x 1" FH MS
- Features:** Grip on top of pull for ease of use.
- Options:** Place your foot on top grip and pull the door open or put your toe underneath and pull the door towards you.



No.	CTC	Projection	Clearance	Weight
FP1230	6"	3 $\frac{1}{4}$ "	3 $\frac{1}{16}$ "	1 lbs. 1.3 oz.



Door Holder/Foot Pull No. 494-RKW

- Material:** Cast brass
- Finishes:** Available in standard architectural finishes (see page 9)
- Other:** Holder base: 3"w x 3 $\frac{3}{8}$ "h
- Holder Projection:** 2 $\frac{1}{8}$ "
- Strike Base** 2"w x 3"h
- Strike Projection:** 3 $\frac{1}{4}$ "
- Options:** Install strike on the bottom of the door to use as a foot pull. Mount the holder to the wall adjacent to the strike and utilize as a door holder.



No.	Fastener	Strike	Weight
494-RKW	Strike: 3 ea. #12 x 1 $\frac{1}{4}$ " FH WS, 3 ea. Plastic anchors Body: 4 ea. #10 x 1 $\frac{1}{4}$ " FH WS	Door	1.7 lbs.

NOTE: 494-RKW can be used as an Automatic Door Holder with Stop, see page D17.

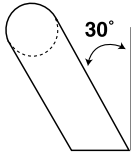

Heavy Duty Offset Door Pulls No. BF257, BF258, BF259, BF260

- Material:** Aluminum, brass, bronze, stainless steel
- Finishes:** Available in standard architectural finishes, US32DMS, US32D316, US32316, white (WPC), red (RPC), and black (BPC) powder coat finishes (see page 6)
- Fastener:** $\frac{3}{8}$ - 16 x 2 $\frac{1}{2}$ " thru bolt & finish washer (standard 1 $\frac{3}{4}$ " door)
- Features:**
- Heavy duty pull and mounting for rough service areas
 - Large footprint on door provides stable mounting
- Options:**
- Advise if door thickness is other than 1 $\frac{3}{4}$ "

No.	Material Size	CTC	Overall	Base	Projection	Clearance	Offset	Weight	ANSI A156.6
BF257	1 $\frac{1}{4}$ " dia.	10"	11 $\frac{1}{4}$ "	1 $\frac{1}{4}$ " x 1 $\frac{7}{16}$ "	3 $\frac{3}{4}$ "	2 $\frac{1}{2}$ "	2 $\frac{5}{16}$ "	8.3 lbs.	J402
BF258	1 $\frac{1}{4}$ " dia.	12"	13 $\frac{1}{4}$ "	1 $\frac{1}{4}$ " x 1 $\frac{7}{16}$ "	3 $\frac{3}{4}$ "	2 $\frac{1}{2}$ "	2 $\frac{5}{16}$ "	9.0 lbs.	J402
BF259	1 $\frac{1}{4}$ " dia.	18"	19 $\frac{1}{4}$ "	1 $\frac{1}{4}$ " x 1 $\frac{7}{16}$ "	3 $\frac{3}{4}$ "	2 $\frac{1}{2}$ "	2 $\frac{5}{16}$ "	11.1 lbs.	J402
BF260	1 $\frac{1}{4}$ " dia.	24"	25 $\frac{1}{4}$ "	1 $\frac{1}{4}$ " x 1 $\frac{7}{16}$ "	3 $\frac{3}{4}$ "	2 $\frac{1}{2}$ "	2 $\frac{5}{16}$ "	13.3 lbs.	J402



No. VRT12



No. VRT22

Vandal Resistant Trim No. VRT12, VRT22

- Material:** Stainless steel
- Finishes:** US32D
- Fastener:** $\frac{1}{4}$ - 20 thru bolt. Other sizes to match locks and exit devices as required
- Features:** VRT22 — soft black textured grip
- Options:**
- Cut for cylinder — use C suffix (VRT22C) when ordering
 - Specify make and model number of exit device when mounting with exit device fastening systems

No.	Material Size	Weight
VRT12	5 $\frac{7}{8}$ " x 12"	2.3 lbs.
VRT22	5 $\frac{7}{8}$ " x 12"	2.3 lbs.

ASSA ABLOY
Opening Solutions

Experience a safer
and more open world

800-458-2424 | www.assaabloydooraccessories.us
Check the web site for the up-to-date catalog

Copyright © 2012-2020, ASSA ABLOY Accessories and Door Controls Group, Inc. All rights reserved. Reproduction in whole or in part without the express written permission of ASSA ABLOY Accessories and Door Controls Group, Inc. is prohibited.

Vandal Resistant Trim No. VRT14, VRT16, VRT24, VRT26



No. VRT14



No. VRT16



No. VRT24



No. VRT26

- Material:** Stainless Steel
- Finishes:** US32D,US32DMS,US10BE
- Fastener:** 1/4 -20 Thru Bolt. Other sizes to match locks and exit devices as required
- Features:**
- Ideal pull for the exterior doors on schools and other public buildings, as well as the rear exit doors of commercial and industrial buildings
 - Vandal Resistant design minimizes opportunity for tampering
 - No exposed fasteners
 - Supplied with thru bolts for non-integrated mounting or can be supplied with mounting points to mate with exit device or mortise lock
 - US Patent No.: D659,507S
- Options:**
- Cut for cylinder use C suffix (VRT24C) when ordering
 - Specify make and model number of exit device when mounting with exit device fastening systems

No.	Integral Latch Guard	Textured Black Grip	Overall	Weight
VRT14	Yes	No	1/8" x 7" x 12"	3.2 lbs.
VRT16	No	No	1/8" x 5 1/2" x 12"	2.5 lbs.
VRT24	Yes	Yes	1/8" x 7" x 12"	3.2 lbs.
VRT26	No	Yes	1/8" x 5 1/2" x 12"	2.5 lbs.

Required Order Information (Please supply all required templates - mating parts and cylinders).

Quantity	Product #	Mating Manufacturer	Mating Part #	Device Template #	Template # for Cylinder Hole Location	Cylinder Diameter	Door Handing	Finish



Vandal Resistant Pull No. VRP 30

Material: 4" x 16" High Strength Steel

Weight: 3.25lbs

Finishes: 10BE, Stock Powder Coats

Fastener: #8 x 3/4" Oval Head Sheet Metal Screws

- Features:**
- Narrow, sloping handle for easy grip and reducing binding opportunities between handles.
 - High strength steel designed for durability and resisting vandalism.
 - Non handed design, reduces risk of installing incorrectly.
 - Backing plate included, removes necessity to repaint opening in retrofit applications.

- Options:**
- Engraving
 - Customer Powder Coat Available
 - Cylinder Option
 - For Mounting with Exit Device: Specify make and model number of exit device and send template when ordering.

Required Order Information (Please supply all required templates - mating parts and cylinders).

Quantity	Product #	Mating Manufacturer	Mating Part #	Device Template #	Template # for Cylinder Hole Location	Cylinder Diameter	Finish

Rockwood Vandal Resistant Order Form

Fill out this form and email to: orders.rockwood@assaabloy.com / or fax to: 800-922-9212

Customer Information

Contact Name: _____ Date: _____
 Company Name: _____ Account #: _____
 Street Address: _____ Phone/Fax: _____ / _____
 City/State/Zip: _____ Email: _____

* Cylinder Prep optional

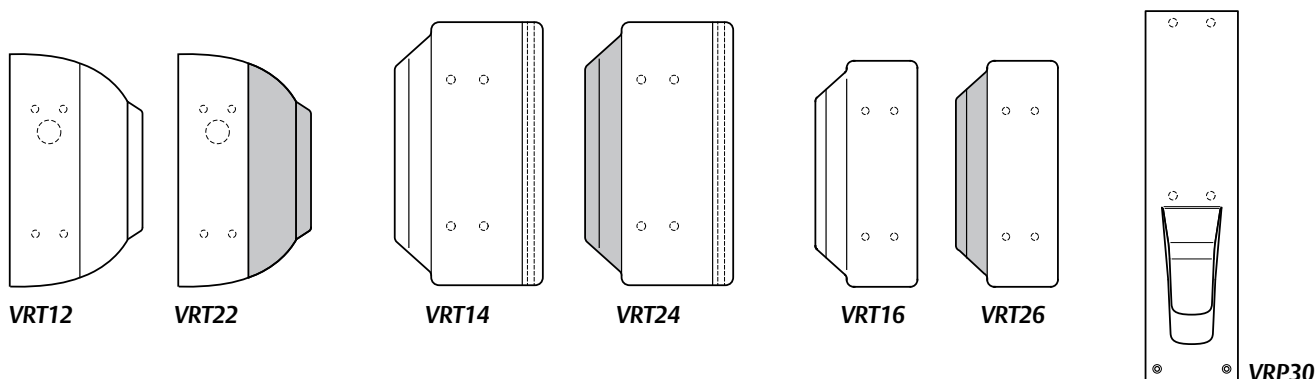

Vandal Resistant Products can be ordered to mount with an exit device, or in conjunction with a mortise lock. Include exit device and mortise lock templates when ordering.

Stud locations shown above are an indication that an exit device can be mated to these pulls. This is not indicating a standard pattern of these studs, we can custom manufacture the pull to the exit device required.

No.	Integral Latch Guard	Textured Black Grip	Size	Weight
VRT12	No	No	5 7/8" x 12"	2.3 lbs
VRT22	No	Yes	5 7/8" x 12"	2.3 lbs
VRT14	Yes	No	6 3/4" x 12"	3.2 lbs
VRT24	Yes	Yes	6 3/4" x 12"	3.2 lbs
VRT16	No	No	5 3/8" x 12"	2.5 lbs
VRT26	No	Yes	5 3/8" x 12"	2.5 lbs
VRP30	N/A	No	4" x 16" - 2 11/16" Proj.	3.25 lbs

Required Order Information (Please supply all required templates)

Qty	Product #	Mating Manufacturer	Part #	Device Template #	Template # for Cylinder Hole Loc.	Cylinder Diameter	Door Handing	Single or Pair	Finish

NOTE: Orders will not be processed until all Templates have been received.
NOTE: Mounting hardware is not provided for VRT to attach with exit device.

800-458-2424 | www.assaabloydooraccessories.us
 Check the web site for the up-to-date catalog

Copyright © 2012-2020, ASSA ABLOY Accessories and Door Controls Group, Inc. All rights reserved. Reproduction in whole or in part without the express written permission of ASSA ABLOY Accessories and Door Controls Group, Inc. is prohibited.

ASSA ABLOY
 Opening Solutions

Experience a safer
 and more open world **B39**

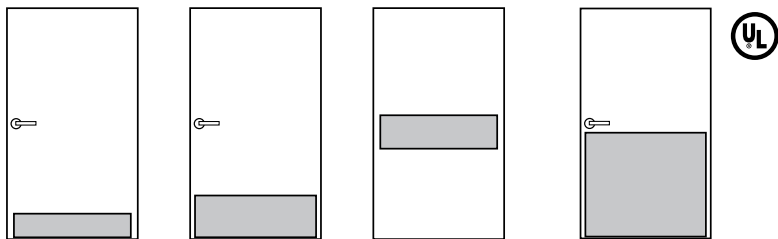

Mop Plate
Up to 6" h x 48" w

Kick Plate
6" to 12" h x 48" w

Stretcher Plate
6" to 12" h and up
to 48" w

Armor Plate
Up to 48" h x 48" w and
available in most finishes

Width of Plates:

Push Side: 2" less than door width.

Pull Side: 1½" less than door width.

NFPA 80 STANDARDS — 2-4.5 Protection Plates:

Factory-installed protection plates shall be installed in accordance with the listing of the door. Field-installed protection plates shall be labeled and installed in accordance with their listing.

Exception: Labeling is not required where the top of the protection plate is not more than 16" (406 mm) above the bottom of the door.

OPTIONAL Self-Drilling TEK Screws: Cuts door plate installation time in half.

Metal Door Plate – Economy Duty No. K1038

Material: .038" aluminum, stainless steel

Finishes: US32D

Fastener: #6 x 5/8" OH SMS

Ordering: Specify height x width x finish code. Add any options

Weight: 8" x 34" = 3.2 lbs

Options:

- SA – self-adhesive mounting
- TORX – security Torx screws
- TEK – self-drilling screws
- Cutouts for locks, louvers, or windows (see worksheets on pages C14-C15 for details on how to order)

Metal Door Plate - Standard Duty No. K1050

Material: .050" Stainless Steel

Finishes: US32D

Fastener: #6 x 5/8" OH SMS

Options:

- Beveled Edge and Counter Sink included
- One day shipping available
- Door markings are not available on quick ship

Metal Door Plate – Standard Duty No. K1050, K1050F

Material: .050" aluminum, brass, bronze, stainless steel

Finishes: US10BE, US32D, US32DMS

Fastener: #6 x 5/8" OH SMS

Ordering: Specify height x width x finish code. Add any options

Weight: 8" x 34" = 4.0 lbs

ANSI: J101 - metal armor plate, J102 - metal kick plate, J103 - metal stretcher & mop plate

Options:

- SA – self-adhesive mounting
- TEK – self-drilling screws
- Beveled 3 or 4 edges, specify B3E or B4E
- Cutouts for locks, louvers, or windows (see worksheets on pages C14-C15 for details on how to order)
- Heavy bevel available, specify HVBEV
- Screw mounting (K1050F) and UL listed for use on 90-minute label wood doors and 3-hour label metal doors
- CSK – countersunk holes
- TORX – security Torx screws

Windstorm Plate – K1050WS

Material: .050" Aluminium, Brass, Bronze, Stainless Steel

Finishes: Standard Architectural Finishes

Fastener: #10 x 5/8" Pan Head Tek Screws

Ordering: Part # when ordering is K1050WS

All plates are UL and Windstorm rated

Options:

- Cutouts for locks, louvers or windows
- Rounded Corners
- Heavy Bevel
- Screw Mount only



Certified to the below standards:

- ICC-500 (2014)

- FEMA Guideline 320 (2014)

- FEMA Guideline 361 (2015)

Part of windstorm assembly cards: ZHLA.45, ZHLA.46, ZHLA.47, ZHLA.51, ZHLA.53, ZHLA.54

800-458-2424 | www.assaabloydooraccessories.us

Check the web site for the up-to-date catalog

Copyright © 2012-2020, ASSA ABLOY Accessories and Door Controls Group, Inc. All rights reserved. Reproduction in whole or in part without the express written permission of ASSA ABLOY Accessories and Door Controls Group, Inc. is prohibited.

ASSA ABLOY
Opening Solutions

Experience a safer
and more open world

Shaped Metal Door Plates – Standard Duty No. K1050-1 thru K1050-8

Material: .050" stainless steel

Finishes: US32, US32D, US32DMS

Fastener: #6x⁵/₈" OH SMS

Ordering: Specify height x width x finish code. Add any options

Weight: 8"x34" = 4.0 lbs

ANSI: J101 – metal armor plate, J102 - metal kick plate, J103 - metal stretcher & mop plate

- Options:**
- TEK – self-drilling screws
 - CSK – countersunk holes
 - Cutouts for locks, louvers, or windows (see worksheets on pages C14-C15 for details on how to order)
 - TORX – security Torx screws
 - Screw mounting (K1050F) and UL listed for use on 90-minute label wood doors and 3-hour label metal doors
 - Any design is possible. Submit your drawings for a custom quote

No. K1050-1

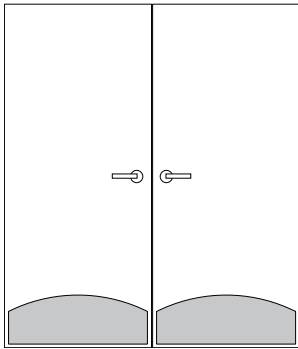

No. K1050-2

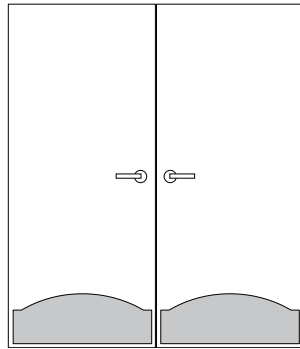

No. K1050-3

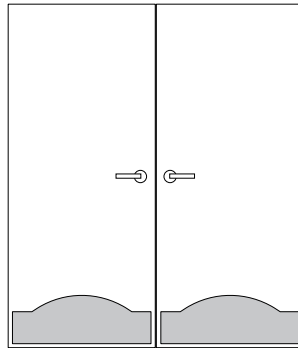

No. K1050-4

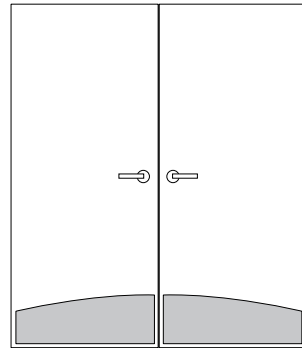

No. K1050-5

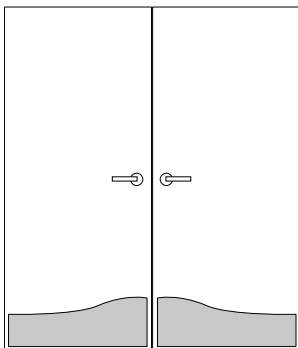

No. K1050-6

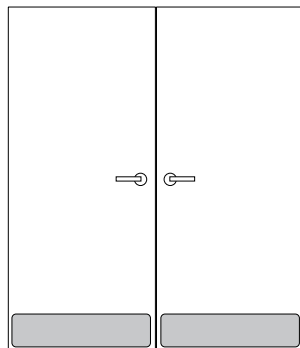

No. K1050-7

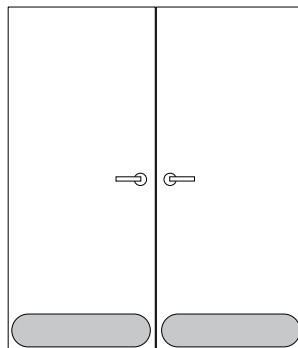

No. K1050-8

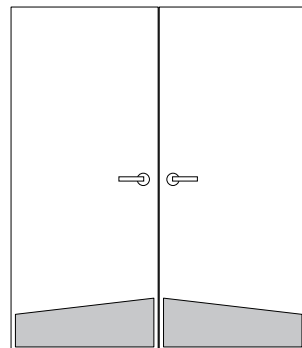

ASSA ABLOY
Opening Solutions

Experience a safer
and more open world

800-458-2424 | www.assaabloydooraccessories.us
Check the web site for the up-to-date catalog

Copyright © 2012-2020, ASSA ABLOY Accessories and Door Controls Group, Inc. All rights reserved. Reproduction in whole or in part without the express written permission of ASSA ABLOY Accessories and Door Controls Group, Inc. is prohibited.

Shaped Metal Armor Plates - Standard Duty No. K1050A-1 thru K1050A-8

Material: .050" stainless steel

Finishes: US32, US32D, US32DMS

Fastener: #6 x 5/8" OH SMS

Ordering: Specify height x width x finish code. Add any options

Weight: 36" x 34" = 18 lbs

ANSI: J101 – metal armor plate, J102 - metal kick plate, J103 - metal stretcher & mop plate

- Options:**
- TEK – self-drilling screws
 - CSK – countersunk holes
 - Cutouts for locks, louvers, or windows (see worksheets on pages C14-C15 for details on how to order)
 - TORX – security Torx screws
 - Screw mounting (K1050F) and UL listed for use on 90-minute label wood doors and 3-hour label metal doors
 - Any design is possible. Submit your drawings for a custom quote

No. K1050A-1

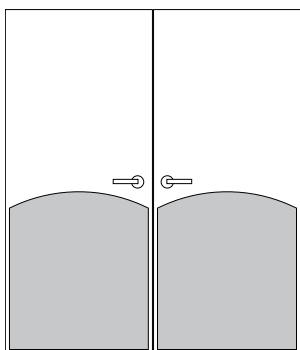

No. K1050A-2

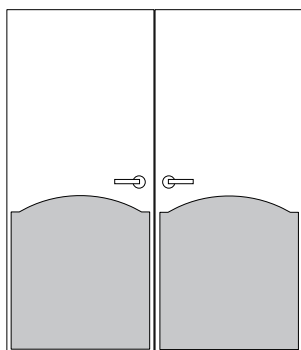

No. K1050A-3

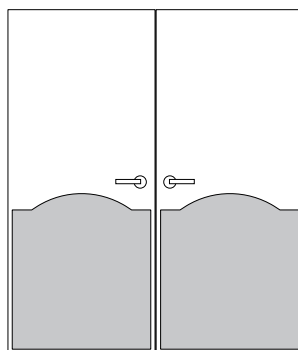

No. K1050A-4

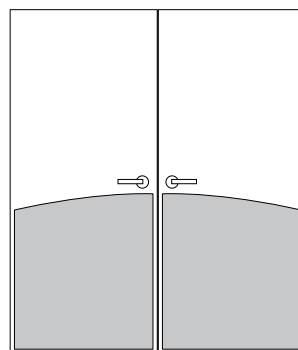

No. K1050A-5

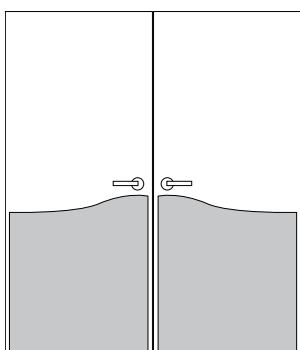

No. K1050A-6

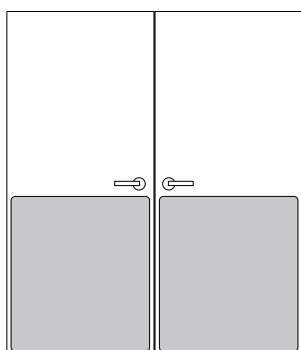

No. K1050A-7

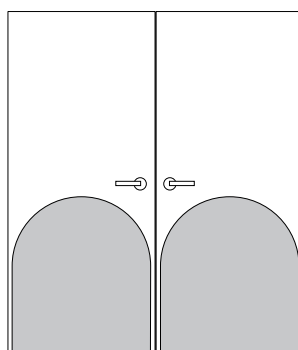

No. K1050A-8

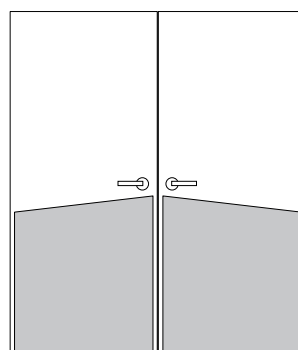

800-458-2424 | www.assaabloydooraccessories.us

Check the web site for the up-to-date catalog

Copyright © 2012-2020, ASSA ABLOY Accessories and Door Controls Group, Inc. All rights reserved. Reproduction in whole or in part without the express written permission of ASSA ABLOY Accessories and Door Controls Group, Inc. is prohibited.

ASSA ABLOY
Opening Solutions

Experience a safer
and more open world

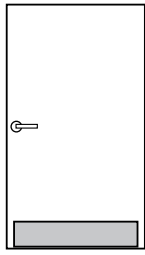
**Mop Plate**

Up to 6" h x 48" w

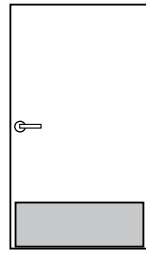
**Kick Plate**

6" to 12" h x 48" w

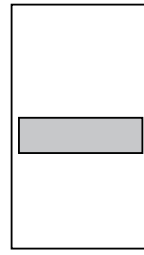
**Stretcher Plate**

6" to 12" h and up to 48" w

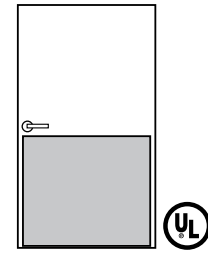
**Armor Plate**Up to 48" h x 48" w
and available in
most finishes**Width of Plates:**

Push side: 2" less than door width. Pull side: 1 1/2" less than door width.

Metal Door Plate – Heavy Duty No. K1062

Material: .062" stainless steel**Finishes:** US10BE, US32D, US32DMS**Fastener:** #6 x 5/8" OH SMS**Ordering:** Specify height x width x finish code. Add any options**Weight:** 8" x 34" = 5.0 lbs**ANSI:** J101 – metal armor plate, J102 – metal kick plate, J103 – metal stretcher & mop plate

- Options:**
- TEK – self-drilling screws
 - CSK – countersunk holes
 - Cutouts for locks, louvers, or windows (see worksheets on pages C14-C15 for details on how to order)
 - Beveled 3 or 4 edges, specify B3E or B4E
 - TORX – security Torx screws
 - Heavy bevel available, specify HVBEV

Metal Door Plate – Extra Heavy Duty No. K1125

Material: .125" aluminum, brass, bronze, stainless steel**Finishes:** Available in standard architectural finishes, US32D**316** (see page 9)**Fastener:** #6 x 5/8" OH SMS**Ordering:** Specify height x width x finish code. Add any options**Weight:** 8" x 34" = 10.0 lbs**ANSI:** J101 – metal armor plate, J102 – metal kick plate, J103 – metal stretcher & mop plate

- Options:**
- TEK – self-drilling screws
 - Beveled 3 or 4 edges, specify B3E or B4E (not applicable on Aluminum Diamond Plate)
 - Cutouts for locks, louvers, or windows (see worksheets on pages C14-C15 for details on how to order)
 - TORX – security Torx screws

Metal Door Plate – Extra Heavy Duty Diamond Plate No. K1125 DIA

Material: .125" aluminum**Finishes:** Polished aluminum diamond plate (ALM DIA)**Fastener:** #6 x 5/8" OH SMS**Ordering:** Specify height x width x finish code. Add any options**Weight:** 8" x 34" = 10.0 lbs**ANSI:** J101 – metal armor plate, J102 – metal kick plate, J103 – metal stretcher & mop plate

- Options:**
- TEK – self-drilling screws
 - Cutouts for locks, louvers, or windows (see worksheets on pages C14-C15 for details on how to order)
 - TORX – security Torx screws

ALM DIA
Polished Aluminum
Diamond Plate**ASSA ABLOY**
Opening SolutionsExperience a safer
and more open world800-458-2424 | www.assaabloydooraccessories.us

Check the web site for the up-to-date catalog

Copyright © 2012-2020, ASSA ABLOY Accessories and Door Controls Group, Inc. All rights reserved. Reproduction in whole or in part without the express written permission of ASSA ABLOY Accessories and Door Controls Group, Inc. is prohibited.

Plastic Door Plate - Heavy Duty No. K2060

- Material:** .060" Kydex® 160 PVC acrylic alloy plastic*
- Finishes:** Beige #72005, calcutta black #52000, chocolate brown #72010, pewter gray #52001
- Fastener:** #6 x³/₄" TH SMS
- Ordering:** Specify height x width x color. Add any options
- Weight:** 8" x 34" = 1.0 lbs
- ANSI:** J105 - plastic armor plate, J106 - plastic kick plate, J107 – plastic stretcher & mop plate
- Options:**
- Cutouts for locks, louvers, or windows (see worksheets on pages C14-C15 for details on how to order)
 - SA – self-adhesive mounting (K2060SA)
 - SA-F – self-adhesive mounting (K2060SA-F) and UL approved for use of 90-minute wood doors and 3-hour metal doors 

Plastic Door Plate – Extra Heavy Duty No. K2125

- Material:** .125" Kydex® 160 PVC acrylic alloy plastic*
- Finishes:** Beige #72005, calcutta black #52000, chocolate brown #72010, pewter gray #52001
- Fastener:** #6 x³/₄" TH SMS
- Ordering:** Specify height x width x color. Add any options
- Weight:** 8" x 34" = 1.8 lbs
- ANSI:** J105 – plastic armor plate, J106 - plastic kick plate, J107 – plastic stretcher & mop plate
- Options:**
- Cutouts for locks, louvers, or windows (see worksheets on pages C14-C15 for details on how to order)
 - CSK – countersunk holes

*Kydex 160 meets Class 1A building code ratings up to .060" thick.

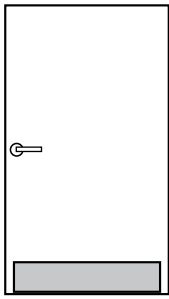
**Mop Plate**

Up to 6" h x 48" w

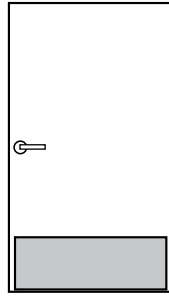
**Kick Plate**

6" to 12" h x 48" w

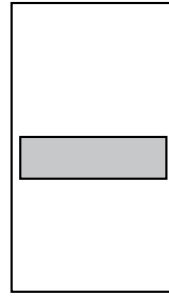
**Stretcher Plate**

6" to 12" h and up to 48" w

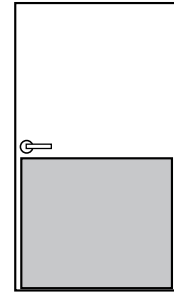
**Armor Plate**

Up to 48" h x 48" w

Width of Plates:

Push side: 2" less than door width. Pull side: 1 1/2" less than door width.

Laminate Plastic Door Plate No. K3125

Material: .125" laminate plastic**Finishes:** Beige, black, brown, pewter gray, white**Fastener:** #6 x 3/4" TH SMS**Ordering:** Specify height x width x finish code x color. Add any options**Weight:** 8" x 34" = 1.8 lbs**ANSI:** J105 – plastic armor plate, J106 - plastic kick plate, J107 – plastic stretcher & mop plate

Options:

- SA – self-adhesive mounting (K3125SA)
- Cutouts for locks, louvers, or windows (see worksheets on pages C14-C15 for details on how to order)
- CSK – countersunk holes

Clear Plastic Door Plate No. K4125

Material: .125" clear plastic**Finishes:** Clear**Fastener:** #6 x 3/4" TH SMS**Features:** Break and scratch resistant**Ordering:** Specify height x width. Add any options**Weight:** 8" x 34" = 1.5 lbs**ANSI:** J105 – plastic armor plate, J106 - plastic kick plate, J107 – plastic stretcher & mop plate

Options:

- Cutouts for locks, louvers, or windows (see worksheets on pages C14-C15 for details on how to order)
- CSK – countersunk holes

ASSA ABLOY
Opening Solutions

Experience a safer
and more open world

800-458-2424 | www.assaabloydooraccessories.us
Check the web site for the up-to-date catalog

Copyright © 2012-2020, ASSA ABLOY Accessories and Door Controls Group, Inc. All rights reserved. Reproduction in whole or in part without the express written permission of ASSA ABLOY Accessories and Door Controls Group, Inc. is prohibited.

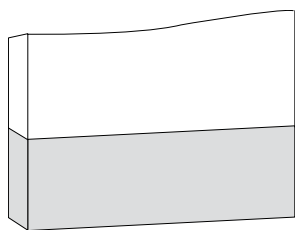

One-Sided Angle Plate No. KB1150

- Material:** .050" aluminum, brass, bronze, stainless steel
- Finishes:** Available in standard architectural finishes (see page 9)
- Fastener:** #6 x $\frac{5}{8}$ " FH/OH SMS
- Ordering:** Provide drawing specifying size, and square or bevel edge door
- 87 degrees - Pull side of beveled door
 - 90 degrees - Push/Pull side of square door
 - 93 degrees - Push side of beveled door
- Options:**
- Beveling, TORX – security Torx screws
 - TEK – self-drilling screws
 - Cutouts for hinges, flush bolts, and locks
 - UL Listed (screw applied)

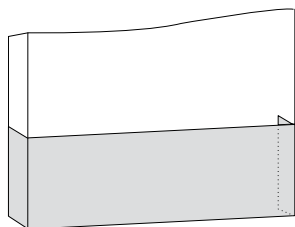

Two-Sided Angle Plate No. KB1151

- Material:** .050" aluminum, brass, bronze, stainless steel
- Finishes:** Available in standard architectural finishes (see page 9)
- Fastener:** #6 x $\frac{5}{8}$ " FH/OH SMS
- Ordering:** Provide drawing specifying size, and square or bevel edge door
- Both 90 degree bends on push or pull side of square door
 - Both 93 degree bends on push side of beveled door
 - One 90 degree bend and One 93 degree bend on push side of beveled/square door
 - Both 87 degree bends on pull side beveled door
 - One 90 degree bend and One 87 degree bend on pull side of beveled/square door
- Options:**
- Beveling, TORX – security Torx screws
 - TEK – self-drilling screws
 - Cutouts for hinges, flush bolts, and locks
 - UL Listed (screw applied)

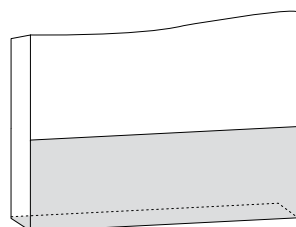

Bottom Angle Plate No. KB1152

- Material:** .050" aluminum, brass, bronze, stainless steel
- Finishes:** Available in standard architectural finishes (see page 9)
- Fastener:** #6 x $\frac{5}{8}$ " FH/OH SMS
- Ordering:** Provide drawing specifying size, and square or bevel edge door
- Always 90 degree bends
- Options:**
- Beveling, TORX – security Torx screws
 - TEK – self-drilling screws
 - UL Listed (screw applied)

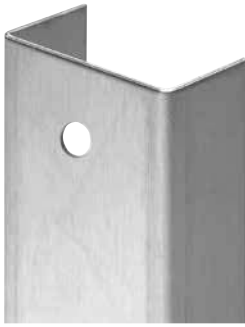

Mortise Door Edges No. 300, 301, 302, 302B

Material: .050" brass, bronze, prime coated steel, stainless steel

Finishes: Available in standard architectural finishes, US32DMS, US32D316, prime painted steel (see page 9)

Fastener: #6 x 5/8" FH SMS

Ordering: Specify any length up to 96" (standard lengths are 42", 84", 96")
 NOTE: 84" and 96" are made to match net door height – specify.

Features: Door edges are sized to be mortised into the surface of 1 3/4" thick wood doors.
 Advise if your door is another thickness
 NOTE: Some wood doors that are nominally 1 3/4" vary significantly.

Options:

- UL fire rated listed for stainless steel, brass and bronze. For use on wood or plastic faced fire doors rated up to and including 1 1/2 hours or hollow metal, steel covered, composite type fire doors rated up to and including 3 hours. Specify UL when ordering (300-UL)
- Cutouts for flush bolts, lock strikes, locks, and hinges (see worksheets on pages C10-C11 or C13-C15 for details on how to order)

NOTE: Your door thickness is a nominal dimension. Doors can vary + or - 1/16" from the nominal dimension. When ordering, verify actual door thickness to assure a working fit of the door edge.

No. 300
ANSI 156.6 - J204

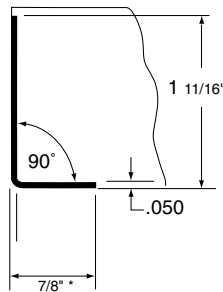

No. 301
ANSI 156.6 - J205

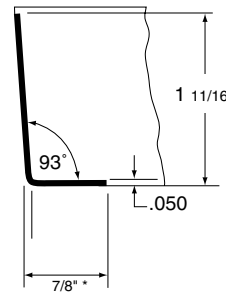

No. 302
ANSI 156.6 - J210

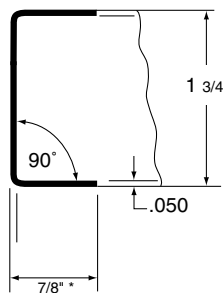

No. 302B
ANSI 156.6 - J211

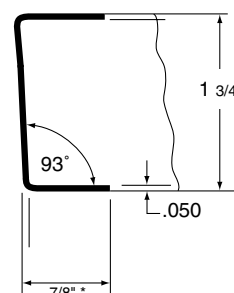

* Modified leg lengths available.



Non-Mortise Door Edges No. 304, 305, 306-RKW, 306-AST, 306B, 306B-AST, 307

Material: .050" brass, bronze, prime coated steel, stainless steel

Finishes: Available in standard architectural finishes, US32DMS, US32D316, prime painted steel (see page 9)

Fastener: #6 x 5/8" FH SMS

Features:

- Door edges are sized for 1 3/4" thick wood or metal doors. Advise if your door is another thickness

NOTE: Some wood doors that are nominally 1 3/4" vary significantly.

- 306-AST and 306B-AST include an astragal, providing additional protection against vandalism

Ordering: Specify any length up to 96" (standard lengths are 42", 84", 96")

NOTE: 84" and 96" are made to match net door height – specify.

Specify wood or metal door

Options:

- UL fire rated listed for stainless steel, brass and bronze. For use on wood or plastic faced fire doors rated up to and including 1 1/2 hours or hollow metal, steel covered, composite type fire doors rated up to and including 3 hours. Specify UL when ordering (306-UL)
- Cutouts for flush bolts, lock strikes, locks, and hinges (see worksheets on pages C10-C11 or C13-C15 for details on how to order)

NOTE: Your door thickness is a nominal dimension. Doors can vary + or - 1/16" from the nominal dimension. When ordering, verify actual door thickness to assure a working fit of the door edge.

No. 304

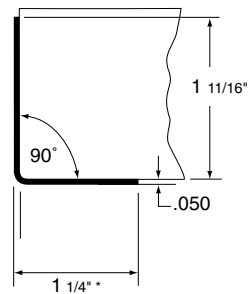

No. 305

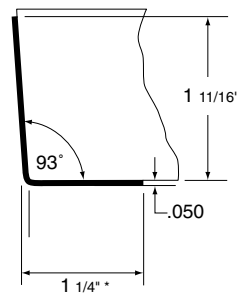

No. 306-RKW

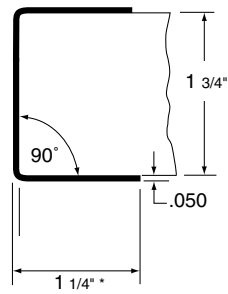

No. 306-AST
(with Astragal)

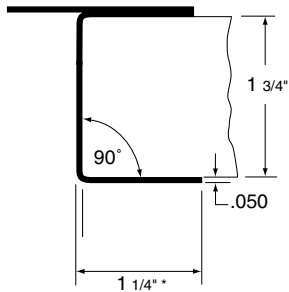

No. 306B

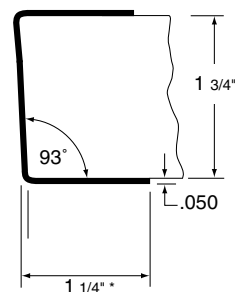

No. 306B-AST
(with Astragal)

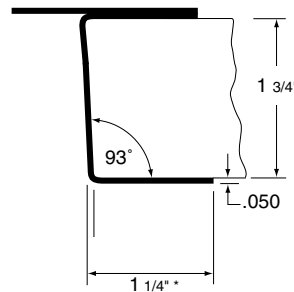

No. 307

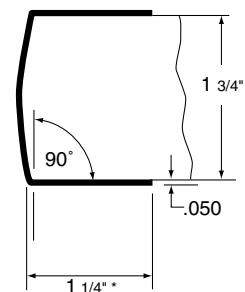

* Modified leg lengths available.

800-458-2424 | www.assaabloydooraccessories.us

Check the web site for the up-to-date catalog

Copyright © 2012-2020, ASSA ABLOY Accessories and Door Controls Group, Inc. All rights reserved. Reproduction in whole or in part without the express written permission of ASSA ABLOY Accessories and Door Controls Group, Inc. is prohibited.

ASSA ABLOY
Opening Solutions

Experience a safer
and more open world

Fill out this form and email/fax form to orders.rockwood@assaabloy.com / or fax to: 800-922-9212.

Customer Information

Company Name: _____ Date: _____

Account#: _____ Phone #/Fax #: _____

Email: _____ PO#: _____

Select a Door Edge

- Mortised: 300 301 302 302B
- Non-Mortised: 304 305 306-RKW 306-AST 306B 306B-AST
- 308 309 310 310B 310BS
- Other _____

Order Line #: _____ Quantity: _____ Handing: _____ Tag. Nos.: _____

Finish: _____

Select Hinge Size, Door Type and Fill in Dimensions

UL Rated

*Door Edge Height if different from net door height

Specify Mounting (if not standard)

- Torx Screws
 Tek Screws

*Standard Door Thickness is 1 3/4" if not please advise:

*Standard Leg Length for non mortised edge is 1 1/4" if not please advise:

*Standard Leg Length for mortised edge is 7/8" if not please advise:

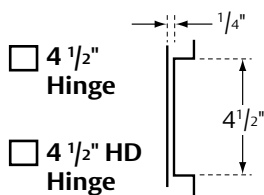
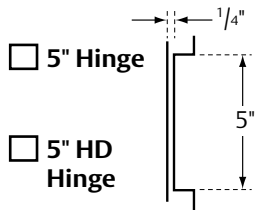

Door with 3 Hinges

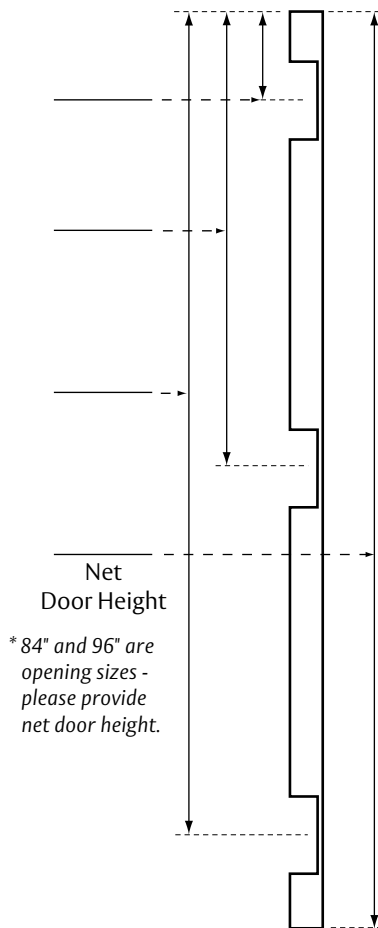

Door with 4 Hinges

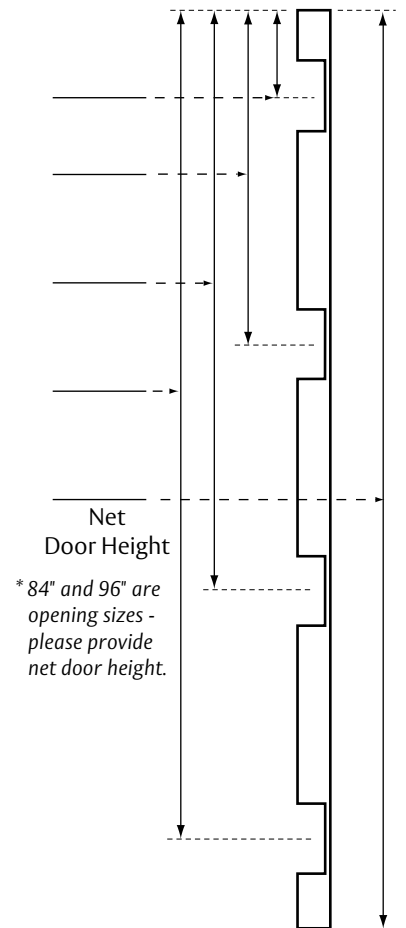

NOTE: Your door thickness is a nominal dimension. Doors can vary + or - 1/16" from the nominal dimension. When ordering, verify actual door thickness to assure a working fit of the door edge.

ASSA ABLOY
Opening Solutions

Experience a safer
and more open world

800-458-2424 | www.assaabloydooraccessories.us
Check the web site for the up-to-date catalog

Copyright © 2012-2020, ASSA ABLOY Accessories and Door Controls Group, Inc. All rights reserved. Reproduction in whole or in part without the express written permission of ASSA ABLOY Accessories and Door Controls Group, Inc. is prohibited.

Fill out this form and email/fax form to orders.rockwood@assaabloy.com / or fax to: 800-922-9212.

Customer Information

Company Name: _____ Date: _____
 Account#: _____ Phone #/Fax #: _____
 Email: _____ PO#: _____

Select a Door Edge

Mortised: 300 301 302 302B
 Non-Mortised: 304 305 306-RKW 306-AST 306B 306B-AST
 308 309 310 310B 310BS
 Other _____

Order Line #: _____ Quantity: _____ Handing: _____ Tag. Nos.: _____
 Finish: _____

Select Cutout, Door Type and Fill in Dimensions

UL Rated
 *Door Edge Height if different from net door height _____
Astragal Side
 (306-AST, 306B-AST ONLY)
 Active Door
 Inactive Door
Specify Mounting
 (if not standard)
 Torx Screws
 Tek Screws

*Standard Door Thickness is 1 3/4" if not please advise:

*Standard Leg Length for non mortised edge is 1 1/4" if not please advise:

*Standard Leg Length for mortised edge is 7/8" if not please advise:

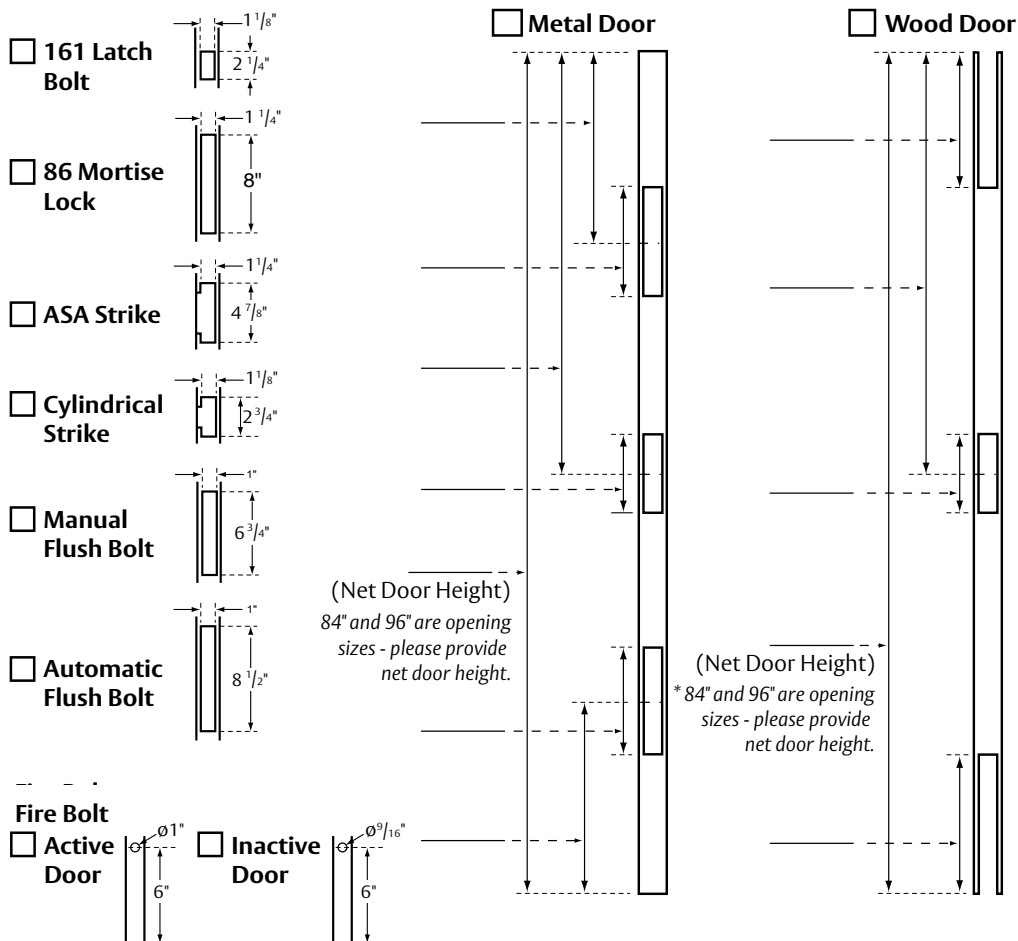

NOTE: Your door thickness is a nominal dimension. Doors can vary + or - 1/16" from the nominal dimension. When ordering, verify actual door thickness to assure a working fit of the door edge.

*Above is a representation of a prep location on the edge of the door.

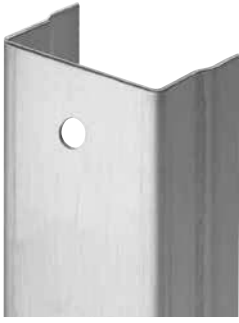

Overlapping Door Edges No. 308, 309, 310, 310S, 310B, 310BS

Material: .050" brass, bronze, prime coated steel, stainless steel

Finishes: Available in standard architectural finishes, US32DMS, US32D316, prime painted steel (see page 9)

Fastener: #6 x 5/8" FH SMS



Ordering: Specify any length (standard length is 42"). Specify wood or metal door

- Options:**
- UL fire rated listed for stainless steel, brass and bronze. For use on wood or plastic faced fire doors rated up to and including 1½ hours or hollow metal, steel covered, composite type fire doors rated up to and including 3 hours. Specify UL when ordering (310-UL)
 - Cutouts for flush bolts, lock strikes, locks, and hinges (see worksheets on pages C10-C11 or C13-C15 for details on how to order)

NOTE: Your door thickness is a nominal dimension. Doors can vary + or - 1/16" from the nominal dimension. When ordering, verify actual door thickness to assure a working fit of the door edge.

No. 308
ANSI 156.6 - J201

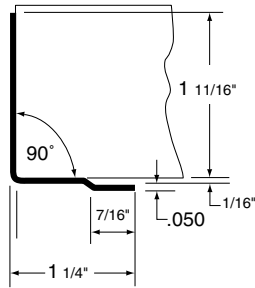

No. 309
ANSI 156.6 - J202

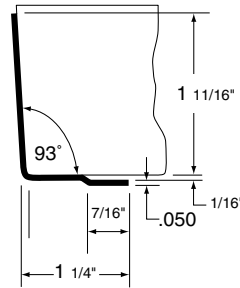

No. 310
ANSI 156.6 - J207

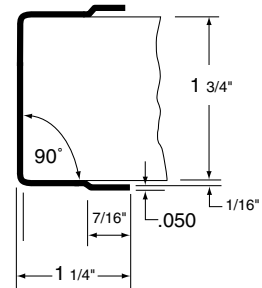

No. 310S
(single side)
ANSI 156.6 - J207

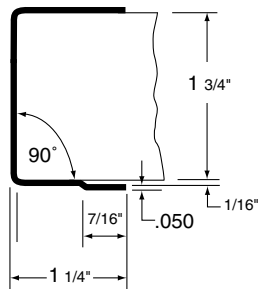

No. 310B
ANSI 156.6 - J208

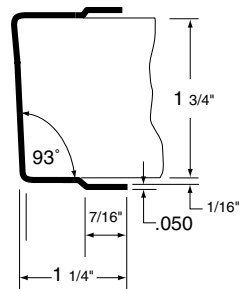

No. 310BS
(single side)
ANSI 156.6 - J208

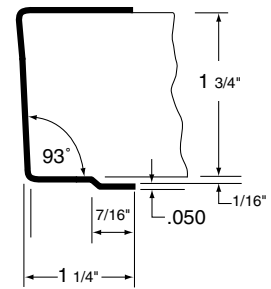

ASSA ABLOY
Opening Solutions

Experience a safer
and more open world

800-458-2424 | www.assaabloydooraccessories.us
Check the web site for the up-to-date catalog

Copyright © 2012-2020, ASSA ABLOY Accessories and Door Controls Group, Inc. All rights reserved. Reproduction in whole or in part without the express written permission of ASSA ABLOY Accessories and Door Controls Group, Inc. is prohibited.

Ordering Instructions

The use of door edges and armor plates not only offers superior protection to expensive doors, it also adds an attractive and functional finishing touch. Armor plates and door edges are available in all architectural finishes. The following two pages are intended to help you determine the cutout locations required on armor plates and door edges. Follow the steps listed to assure complete consideration of all factors concerning cutout locations.

1. Determine the armor plate height. We recommend 48" high. If you cut holes for lock, make the armor plate high enough to provide at least $\frac{1}{2}$ " from edge of the top cutout to the top edge of the plate, or $\frac{1}{2}$ " above the top of the lock front when mortise lock is used. This prevents a cutout running out of the top edge of the plate.
2. Determine the armor plate width. Armor plates are usually mounted on the stop or push side of the door. Measure the net width of the door face and subtract the following depending on the type of door edges you specify:
 - a) non-mortise door edges = $2\frac{5}{8}$ " (for $\frac{1}{8}$ " gap)
 - b) overlapping door edges = 2" (for $\frac{3}{16}$ " overlap)
 - c) no door edges – single door = $1\frac{1}{4}$ "
 - d) no door edges – pairs of doors = 1" (without mullions)
3. List all hardware that will be mounted on the door. Identify those items that will require armor plate and/or door edge cutouts; i.e., lock spindle, cylinder, thumb piece, lock front and strike, flush bolts, hinges, louvers, lites.
4. Determine door undercut and location of armor plate and door edge to bottom of the door. We recommend mounting plates flush with the bottom of the door.
5. Determine location of all hardware cutout centerlines from the bottom of the armor plate.
6. Determine the backset of lock cutouts on the armor plate.

		Square Edge	Bevel Edge
a) with non-mortise door edges	lock backset minus	$1\frac{5}{16}$ "	$1\frac{3}{8}$ "
b) with overlapping door edges	lock backset minus	1"	$1\frac{1}{16}$ "
c) without door edges – single doors	lock backset minus	$\frac{5}{8}$ "	$1\frac{1}{16}$ "
d) without door edges – pair of doors (without mullions)	lock backset minus	$\frac{3}{8}$ "	$\frac{7}{16}$ "

7. Specify the size of cutouts.
8. Determine the hand of the door. Armor plates are typically mounted on the stop or push side of the door. Function holes must be given special attention as they may not be required on reverse bevel doors.

NOTE: Your door thickness is a nominal dimension. Doors can vary + or - $\frac{1}{16}$ " from the nominal dimension. When ordering, verify actual door thickness to assure a working fit of the door edge.

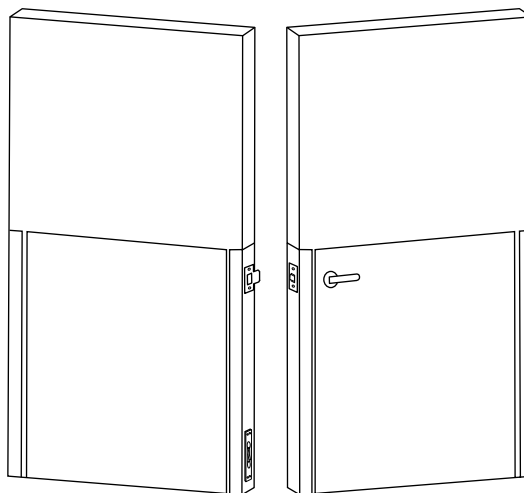

Cutouts

This drawing shows typical location of cutouts on armor plates and door edges. It also illustrates non-mortise door edges, but this can be used as a guide for armor plates with overlapping door edges or no door edges. Use this as a worksheet to make your own drawings or photocopy and fill in your dimensions.

For Hinge Cutouts: Be sure to allow for door undercut and location of edge on door if other than flush with bottom.

For Lock Trim Protection: Consider using a trim protector bar (see pages C16-C20).

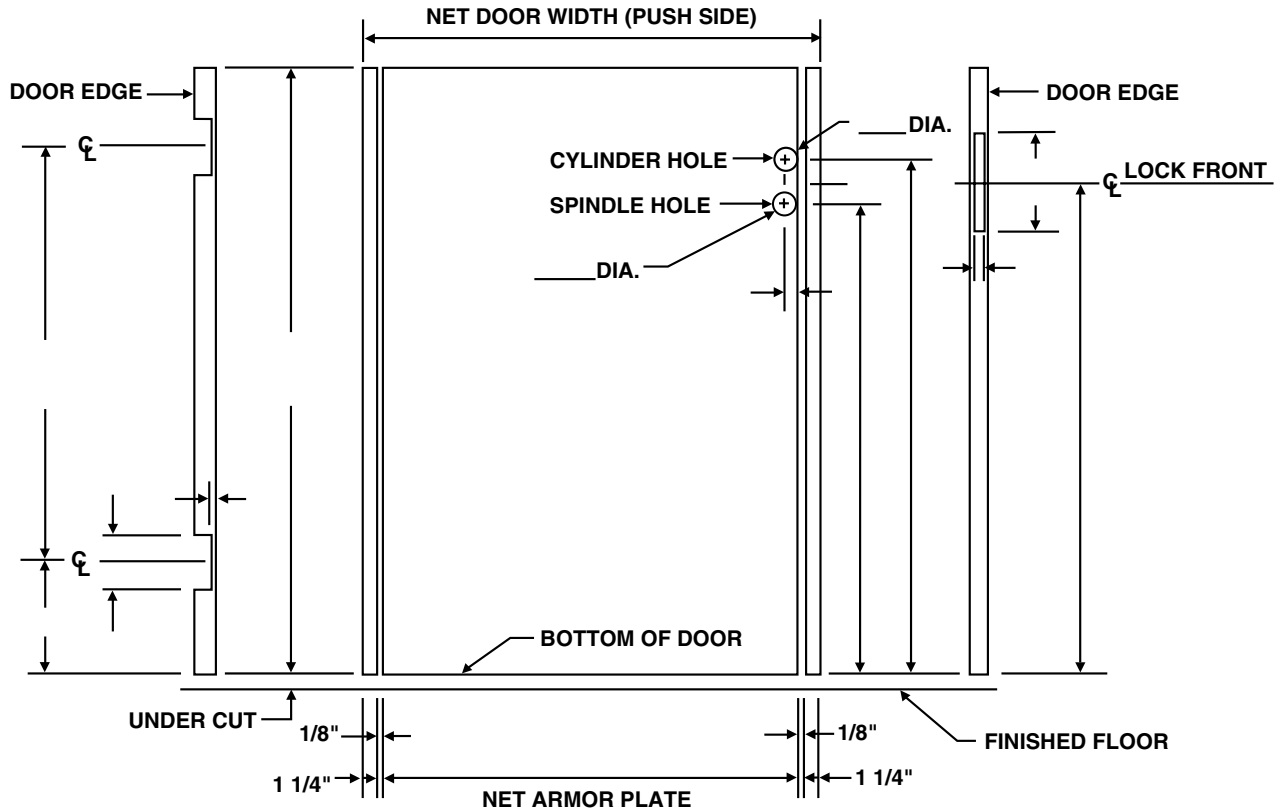

NOTE: Your door thickness is a nominal dimension. Doors can vary + or - 1/16" from the nominal dimension. When ordering, verify actual door thickness to assure a working fit of the door edge.

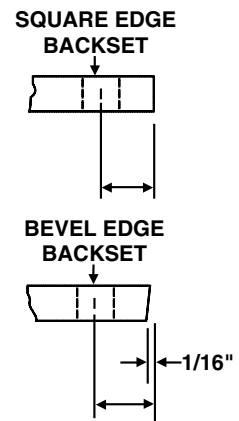

ASSA ABLOY
Opening Solutions

Experience a safer
and more open world

800-458-2424 | www.assaabloydooraccessories.us
Check the web site for the up-to-date catalog

Copyright © 2012-2020, ASSA ABLOY Accessories and Door Controls Group, Inc. All rights reserved. Reproduction in whole or in part without the express written permission of ASSA ABLOY Accessories and Door Controls Group, Inc. is prohibited.

Cutouts

This drawing shows typical location of cutouts on armor plates and door edges. It also illustrates non-mortise door edges, but this can be used as a guide for armor plates with overlapping door edges or no door edges. Use this as a worksheet to make your own drawings or photocopy and fill in your dimensions.

For Hinge Cutouts: Be sure to allow for door undercut and location of edge on door if other than flush with bottom.

For Lock Trim Protection: Consider using a trim protector bar (see pages C16-C20).

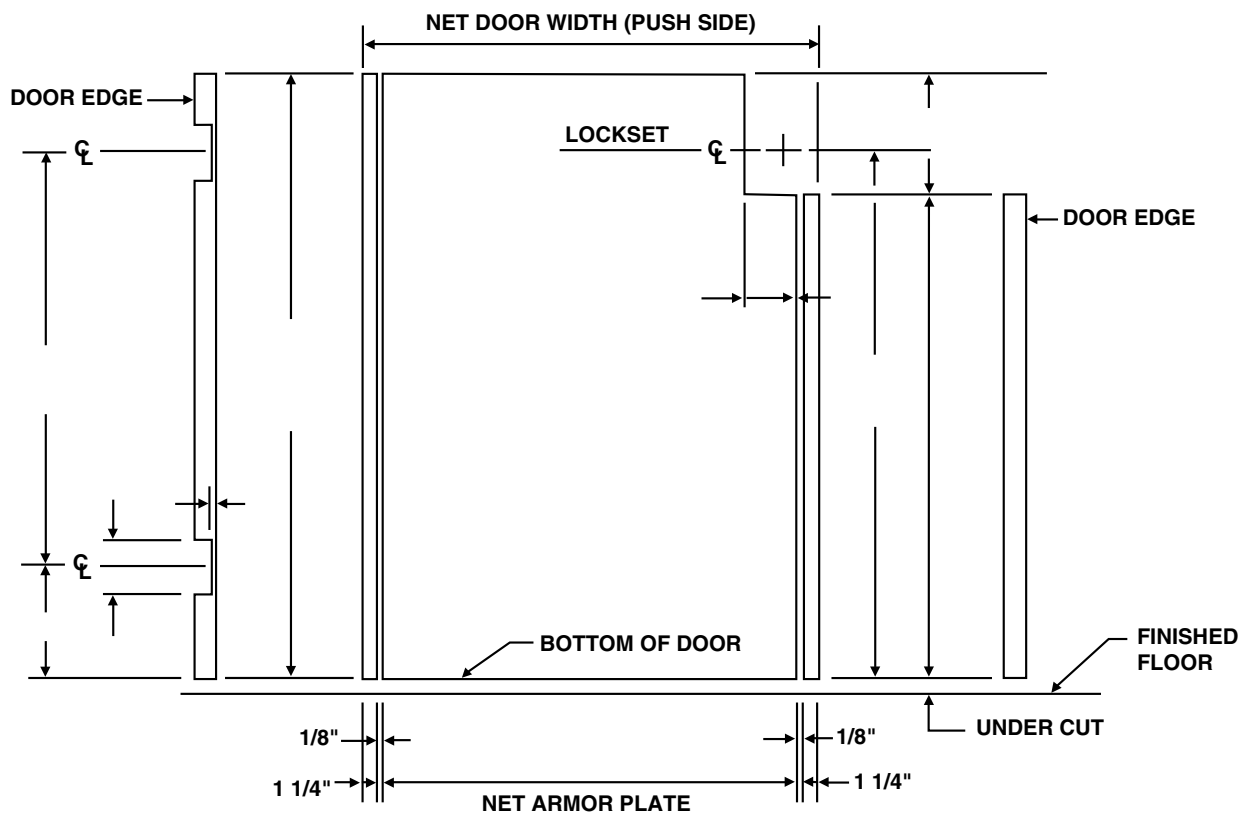

NOTE: Your door thickness is a nominal dimension. Doors can vary + or - 1/16" from the nominal dimension. When ordering, verify actual door thickness to assure a working fit of the door edge.

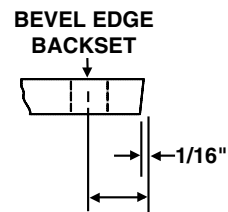
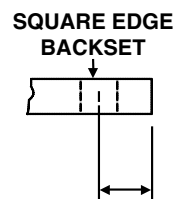

Solutions to Door and Trim Damage

Damage to doors and door trim (exit devices, knobs, levers, etc.) from hallway traffic such as carts and gurneys cost hospitals, schools and other institutions tens of thousands of dollars every year. The following four pages are Rockwood Product's line of Unique, Patented Protection Products designed to prevent this damage. Made from solid stainless steel the line is engineered to deflect traffic safely away from the door or trim.

Our line of trim protector bars is designed to safely deflect traffic away from exit devices, door knobs/levers, or other trim. These bars are made from solid stainless steel and are available in both standard duty ($\frac{3}{16}$ "") and heavy duty ($\frac{3}{8}$ "") versions. The bars are mounted either directly below, over, or in front of the trim depending on the application. They are available in a variety of projections and center to centers to fit your needs. If you require custom designs our engineering department can work with you to meet your needs.

Choosing the correct protection bar:

1. **Determine traffic** – light to moderate use = SD Series, heavy use = HD Series.
2. **Measure projection** – of exit device, door knob, etc.
3. **Review product dimension** – to match bar to your specific needs.



Warning: Do not locate protection bars where they can impede operation of exit devices.

How They Work

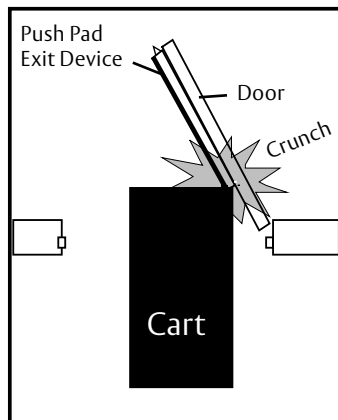

Without Bar – Costly Damage

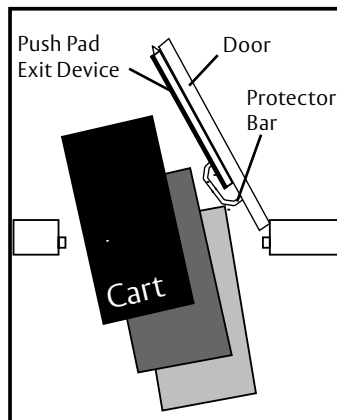

With Bar – Safely Deflected Away

ASSA ABLOY
Opening Solutions

Experience a safer
and more open world

800-458-2424 | www.assaabloydooraccessories.us
Check the web site for the up-to-date catalog

Copyright © 2012-2020, ASSA ABLOY Accessories and Door Controls Group, Inc. All rights reserved. Reproduction in whole or in part without the express written permission of ASSA ABLOY Accessories and Door Controls Group, Inc. is prohibited.

Heavy Duty Application

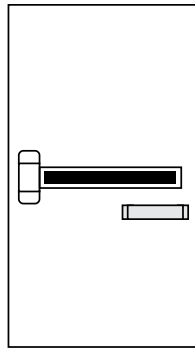

Application shown for product HD2230, HD2240, HD2250.
* Advise if door thickness is other than 1³/₄".

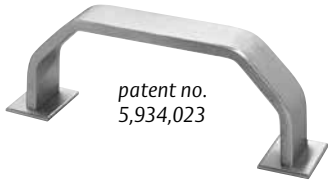

Heavy Duty Protector Bars HD2230, HD2230M

- Material:** Stainless steel
- Finishes:** US32D, US32DMS, US10BE
- Fastener:** 1/4" - 20 x 2 1/4" thru bolt & finish washer (standard 1 3/4" door*)
- Other:** Made to order sizes available

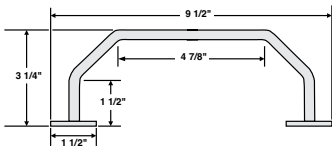

No.	CTC	Material Size	Projection	Weight
HD2230	8"	3/8" x 1 1/2"	3 1/4"	2.3 lbs.
HD2230M	Specify	3/8" x 1 1/2"	3 1/4"	—

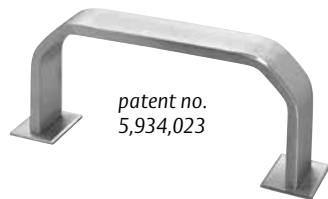

Heavy Duty Protector Bars HD2240, HD2240M

- Material:** Stainless steel
- Finishes:** US32D, US32DMS, US10BE
- Fastener:** 1/4" - 20 x 2 1/4" thru bolt & finish washer (standard 1 3/4" door*)
- Other:** Made to order sizes available

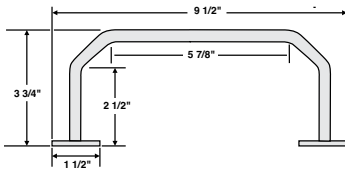

No.	CTC	Material Size	Projection	Weight
HD2240	8"	3/8" x 1 1/2"	3 3/4"	2.5 lbs.
HD2240M	Specify	3/8" x 1 1/2"	3 3/4"	—

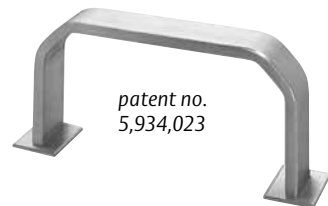

Heavy Duty Protector Bars HD2250, HD2250M

- Material:** Stainless steel
- Finishes:** US32D, US32DMS, US10BE
- Fastener:** 1/4" - 20 x 2 1/4" thru bolt & finish washer (standard 1 3/4" door*)
- Other:** Made to order sizes available

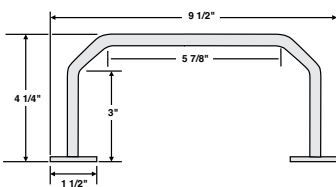

No.	CTC	Material Size	Projection	Weight
HD2250	8"	3/8" x 1 1/2"	4 1/4"	2.7 lbs.
HD2250M	Specify	3/8" x 1 1/2"	4 1/4"	—

800-458-2424 | www.assaabloydooraccessories.us
Check the web site for the up-to-date catalog

Copyright © 2012-2020, ASSA ABLOY Accessories and Door Controls Group, Inc. All rights reserved. Reproduction in whole or in part without the express written permission of ASSA ABLOY Accessories and Door Controls Group, Inc. is prohibited.

ASSA ABLOY
Opening Solutions

Experience a safer
and more open world

Standard Duty Applications

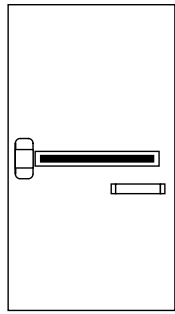

Application shown for product SD1230, SD1240, SD1250.

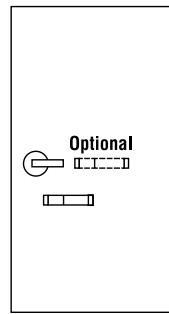

Application shown for product SD1260.



Standard Duty Protector Bar No. SD1230

Material: Stainless steel
Finishes: US32D, US32DMS, US10BE
Fastener: #10-24 x 1 FH MS and sex bolt

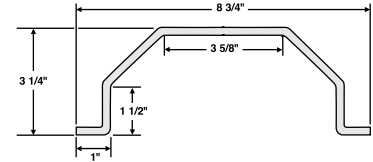

No.	CTC	Material Size	Projection	Weight
SD1230	8"	3/16" x 2"	3 1/4"	1.4 lbs.



Standard Duty Protector Bar No. SD1240

Material: Stainless steel
Finishes: US32D, US32DMS, US10BE
Fastener: #10 - 24 x 1 FH MS and sex bolt

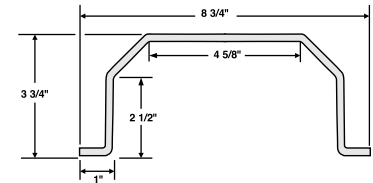

No.	CTC	Material Size	Projection	Weight
SD1240	8"	3/16" x 2"	3 3/4"	1.6 lbs.



Standard Duty Protector Bar No. SD1250

Material: Stainless steel
Finishes: US32D, US32DMS, US10BE
Fastener: #10 - 24 x 1 FH MS and sex bolt

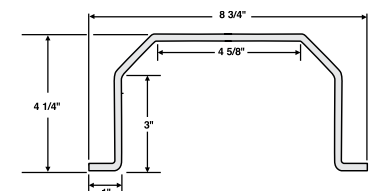

No.	CTC	Material Size	Projection	Weight
SD1250	8"	3/16" x 2"	4 1/4"	1.7 lbs.



Standard Duty Protector Bar No. SD1260

Material: Stainless steel
Finishes: US32D, US32DMS, US10BE
Fastener: #10 - 24 x 1 FH MS and sex bolt

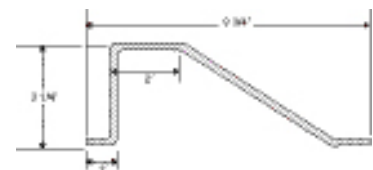

No.	CTC	Material Size	Projection	Weight
SD1260	8"	3/16" x 2"	3 1/4"	1.6 lbs.

ASSA ABLOY
Opening Solutions

Experience a safer and more open world

800-458-2424 | www.assaabloydooraccessories.us
Check the web site for the up-to-date catalog

Copyright © 2012-2020, ASSA ABLOY Accessories and Door Controls Group, Inc. All rights reserved. Reproduction in whole or in part without the express written permission of ASSA ABLOY Accessories and Door Controls Group, Inc. is prohibited.

Applications

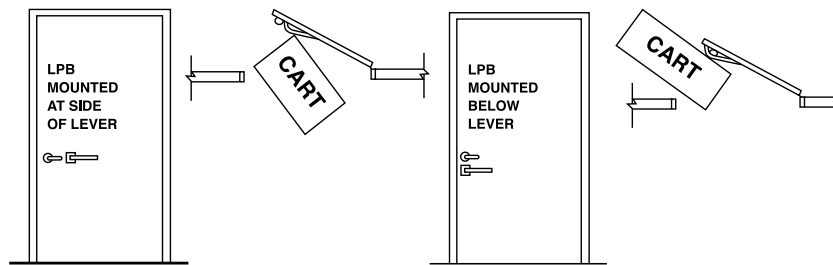

Application shown for product R101LPB thru R115LPB.
* Advise if door thickness is other than 1 3/4".



Trim Protector Bars No. R101LPB, R102LPB

- Material:** Brass, stainless steel
- Finishes:** Available in standard architectural finishes (see page 9)
- Fastener:** 1/4-20 x 2 1/4" thru bolt, 1/4-20 x 2" thru bolt, finish washers (standard 1 3/4" door*)
- Other:** Made to order sizes available

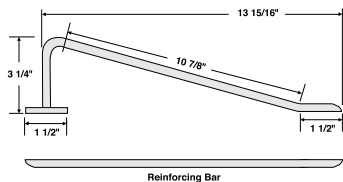

No.	CTC	Material Size	Weight
R101LPB	12"	3/8" x 1 1/2"	2.6 lbs.
R102LPB (with reinforcing bar)	12"	3/8" x 1 1/2"	4.6 lbs.



Trim Protector Bars – Lever Handle No. R111LPB, R112LPB

- Material:** Brass, stainless steel
- Finishes:** Available in standard architectural finishes (see page 9)
- Fastener:** 1/4-20 x 2 1/4" thru bolt, 1/4-20 x 2" thru bolt, finish washers (standard 1 3/4" door*)
- Other:** Made to order sizes available

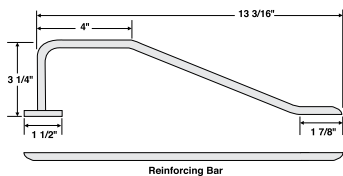

No.	CTC	Material Size	Weight
R111LPB	12"	3/8" x 1 1/2"	2.6 lbs.
R112LPB (with reinforcing bar)	12"	3/8" x 1 1/2"	4.6 lbs.



Trim Protector Bar - Long Lever Handle No. R115LPB

- Material:** Brass, stainless steel
- Finishes:** Available in standard architectural finishes (see page 9)
- Fastener:** 1/4-20 x 2 1/4" thru bolt, 1/4-20 x 2" thru bolt, finish washers (standard 1 3/4" door*)
- Other:** Made to order sizes available

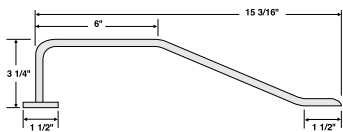

No.	CTC	Material Size	Weight
R115LPB	14"	3/8" x 1 1/2"	3.0 lbs.

EDP Application

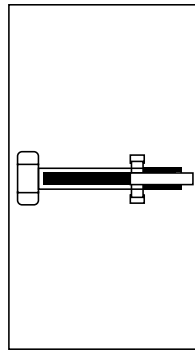

Application shown for product R116EDPL and R116EDPH.
Field cutting hinge end of exit device is required.

* Advise if door thickness is other than 1³/₄".

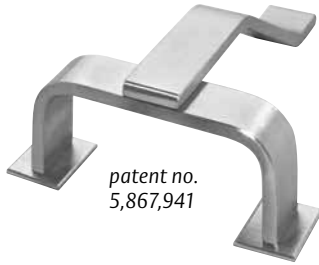

patent no.
5,867,941

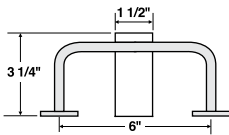
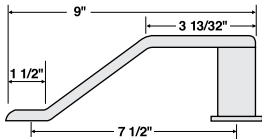

Exit Device Protector No. R116EDPL

Material: Stainless steel

Finishes: US32D, US32DMS, US10BE

Fastener: 2 ea. 1/4-20x2 1/4" thru bolts, 1 ea. 1/4-20x2" thru bolt, finish washers (standard 1³/₄" door*)

Features: Suitable for use with exit devices that project less than 2³/₈" from door face (i.e., SARGENT® 80 series, Monarch® 17 series, and Precision® Apex series)

No.	Material Size	Projection	Weight
R116EDPL	3/8" x 1 1/2"	3 1/4"	3.5 lbs.

® SARGENT 80 series is a registered trademark of Sargent Manufacturing Company.

® Monarch 17 series is a registered trademark of Ingersoll-Rand Company.

® Precision Apex series is a registered trademark of Apex Machine Tool Company.

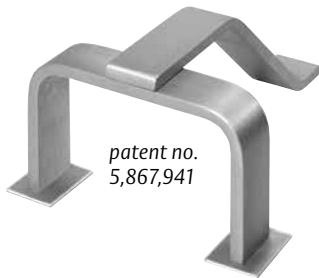

patent no.
5,867,941

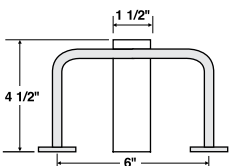
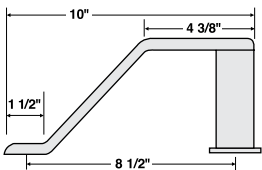

Exit Device Protector No. R116EDPH

Material: Stainless steel

Finishes: US32D, US32DMS, US10BE

Fastener: 2 ea. 1/4-20x2 1/4" thru bolts, 1 ea. 1/4-20x2" thru bolt, finish washers (standard 1³/₄" door*)

Features: Suitable for use with exit devices that project less than 3⁵/₈" from door face (i.e., Von Duprin® 33, 98 and 99 series, Yale® 7000 series, Corbin Russwin® ED500 series)

No.	Material Size	Projection	Weight
R116EDPH	3/8" x 1 1/2"	4 1/2"	3.7 lbs.

® VonDuprin 33, 98, and 99 series is a registered trademark of Ingersoll-Rand Company.

® Yale 7000 series is a registered trademark of Yale Security Group.

® Corbin Russwin ED500 series is a registered trademark of Corbin Russwin, Inc.

ASSA ABLOY
Opening Solutions

Experience a safer
and more open world

800-458-2424 | www.assaabloydooraccessories.us

Check the web site for the up-to-date catalog

Copyright © 2012-2020, ASSA ABLOY Accessories and Door Controls Group, Inc. All rights reserved. Reproduction in whole or in part without the express written permission of ASSA ABLOY Accessories and Door Controls Group, Inc. is prohibited.

Vertical Rod Cover

The vertical rod cover (BFRC) is a sturdy channel made of .050" stainless steel (other finishes available) designed to fit over the vertical rod, protecting it from damage caused by carts, gurneys, etc. It is available in 12" and 24" lengths.

Latch Guard Cover

The latch guard cover (BFLG) is made of .050" material and is designed with a 45° ramp, which when placed over the latch at the base of the door, deflects traffic safely away. It meets ADA requirements for a "smooth bottom door surface". The BFLG is available in 10", 12", and 16" lengths and most architectural finishes.

Application

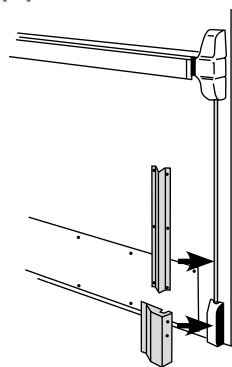

Application shown for products BFRC and BFLG. Protects vertical rod and latch of exit device. Meets ADA "smooth surface" requirements.



Vertical Rod Covers No. BFRC12, BFRC24

Material: .050" brass, bronze, stainless steel
Finishes: Available in standard architectural finishes (see page 9)
Fastener: #6 x 5/8" OH SMS
Other: Made to order sizes available

No.	Height	Width	Projection	Weight
BFRC12	12"	3 1/4"	1 5/8"	0.9 lbs.
BFRC24	24"	3 1/4"	1 5/8"	1.8 lbs.

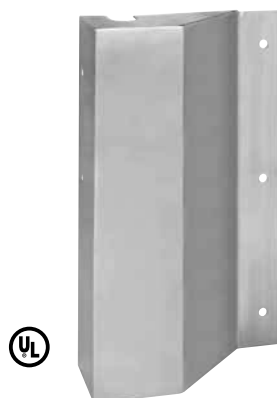

Latch Guard Covers No. BFLG10, BFLG12, BFLG16

Material: .050" stainless steel
Finishes: Available in standard architectural finishes (see page 9)
Fastener: #8 - 32 x 3/4" OH MS; WS available on request
Ordering: Specify handing
Other: Made to order sizes available

No.	Height	Width	Projection	Weight
BFLG10	10"	6"	2 3/8"	1.6 lbs.
BFLG12	12"	6"	2 3/8"	1.9 lbs.
BFLG16	16"	6"	2 3/8"	2.5 lbs.



Vertical Rod Latch Guard Cover No. BFLG1050

Material: .050" Stainless Steel
Finishes: US32D and Stock PC's
Height: 10"
Fastener: #10 x 5/8" Self-Drilling Tek Screws
Ordering: Please specify handing and width of door (push side)

Certified to the below Standards:

- ICC-500 (2014)
- FEMA Guideline 320 (2014)
- FEMA Guideline 361 (2015)

Part of windstorm assembly cards: ZHLA.47 and ZHLA.51

No.	Height	Width	Projection
BFLG1050	10"	Specify	2 3/8"

Rockwood custom strikes are manufactured to your specifications in almost any size, shape and finish. The drawings below represent standard ASA and T strikes. For easy and efficient ordering, please use the order form on the next page and fill in your requirements on drawing(s) and chart then fax or email us the form.

NOTE: Any dimensions are possible. Contact us with your requirements.

Material: .090" brass, bronze, stainless steel

Finishes: US3, US4, US10, US10B, US32D, US32

Fastener: CS-ASA: #12 WS or #12 - 24 MS.
 CS-OM: #12 WS or #12 - 24 MS.
 CS-T: #8 WS or #8 - 24 MS
 590DA: #8 WS or #8 - 24 MS

Bolt Hole: Common sizes are: $1\frac{1}{16}$ " x $1\frac{1}{4}$ " and $\frac{3}{4}$ " x $1\frac{1}{4}$ "; any size available

Options:

- .050", .062", or .125" thickness
- TORX - security Torx screws
- Finish on both sides
- Custom filler plates available
- Full lip

CS-ASA1

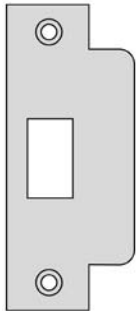

CS-ASA2

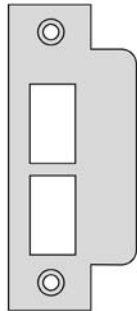

CS-OM

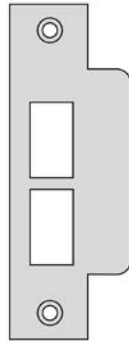

CS-T

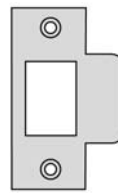

590DA

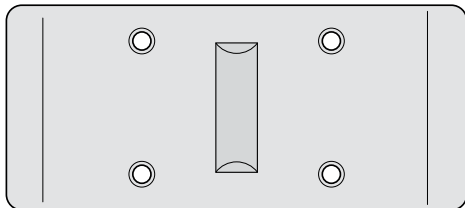

ASSA ABLOY
 Opening Solutions

Experience a safer
 and more open world

800-458-2424 | www.assaabloydooraccessories.us
 Check the web site for the up-to-date catalog

Copyright © 2012-2020, ASSA ABLOY Accessories and Door Controls Group, Inc. All rights reserved. Reproduction in whole or in part without the express written permission of ASSA ABLOY Accessories and Door Controls Group, Inc. is prohibited.

Fill out this form and email/fax form to orders.rockwood@assaabloy.com/800-922-9212.

Customer Information

Contact Name: _____

Date: _____

Company Name: _____

Account #: _____

Address: _____

Phone #/Fax #: _____

City/State/Zip: _____

Email: _____

CS-ASA1

#12 Screw
Specify
Wood
or Metal

Lip to Centerline _____

1 1/4"

4 7/8"

3 3/8"

3/4"

1/8"

Select Bolt Hole Size

1 1/16" x 1 1/4" 3/4" x 1 1/4" Other: W _____ x L _____

CS-ASA2

#12 Screw
Specify
Wood
or Metal

Lip to Centerline _____

1 1/4"

4 7/8"

3 3/8"

3/4"

1/8"

1

2

Select Bolt Hole Size

1. 1 1/16" x 1 1/4" 3/4" x 1 1/4" Other: W _____ x L _____

2. 1 1/16" x 1 1/4" 3/4" x 1 1/4" Other: W _____ x L _____

CS-T

#8 Combo
Screw

Lip to Centerline _____

1 1/8"

2 3/4"

1 1/2"

5/8"

1/8"

Select Bolt Hole Size

1 1/16" x 1 1/4" 3/4" x 1 1/4" Other: W _____ x L _____

CS-OM

#12 Screw
Specify
Wood
or Metal

Lip to Centerline _____

1 1/4"

5 3/4"

3 1/2"

1 1/4"

1/8"

1

2

Select Bolt Hole Size

1. 1 1/16" x 1 1/4" 3/4" x 1 1/4" Other: W _____ x L _____

2. 1 1/16" x 1 1/4" 3/4" x 1 1/4" Other: W _____ x L _____

Order Form for CS-ASA1, CS-ASA2, CS-OM, CS-T

Order Line #	Qty	Part #	Flat or Curved	LH	RH	MS or WS Fastener	Finish
Options							

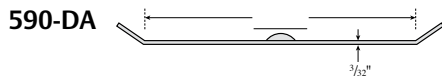

Order Form for 590-DA

Is Door: Center Hung! Flush with Jamb²

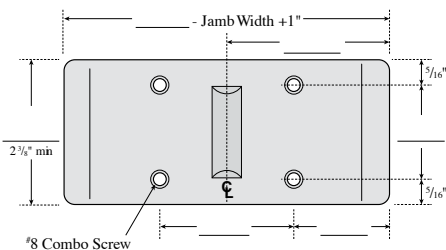

Order Line #	Quantity	Part #	Jamb Width	Finish
Options				

800-458-2424 | www.assaabloydooraccessories.us

Check the web site for the up-to-date catalog

Copyright © 2012-2020, ASSA ABLOY Accessories and Door Controls Group, Inc. All rights reserved. Reproduction in whole or in part without the express written permission of ASSA ABLOY Accessories and Door Controls Group, Inc. is prohibited.

ASSA ABLOY
Opening Solutions

Experience a safer
and more open world **C23**

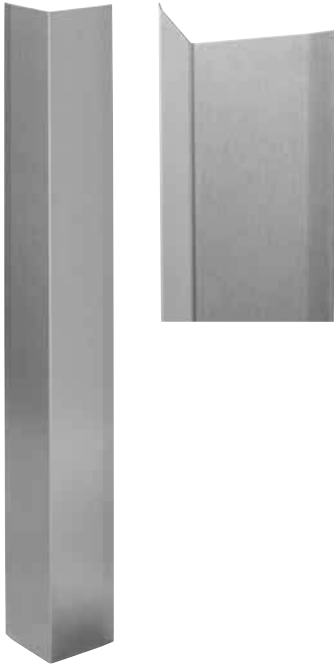

Corner Guards No. 290, 291

- Material:** .050" brass, bronze, stainless steel
Finishes: Available in standard architectural finishes (see page 9)
Mounting: Self-adhesive mounting
Ordering: Specify size
Other: Other lengths available up to 96", leg widths up to 6"

No.	Standard Sizes	Top Corners	Weight
290	2" x 2" x 40"	Square	2.4 lbs.
	2" x 2" x 48"		2.8 lbs.
	3" x 3" x 40"		3.5 lbs.
	3" x 3" x 48"		4.2 lbs.
291	2" x 2" x 40"	Rounded	2.4 lbs.
	2" x 2" x 48"		2.8 lbs.
	3" x 3" x 40"		3.5 lbs.
	3" x 3" x 48"		4.2 lbs.

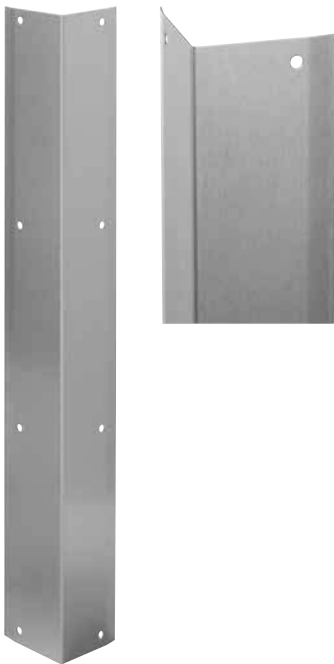

Corner Guards No. 295, 296

- Material:** .050" brass, bronze, stainless steel
Finishes: Available in standard architectural finishes (see page 9)
Fastener: #6 x 5/8" OH SMS
Ordering: Specify size
Other: Other lengths available up to 96", leg widths up to 6"

No.	Standard Sizes	Top Corners	Weight
295	2" x 2" x 40"	Square	2.4 lbs.
	2" x 2" x 48"		2.8 lbs.
	3" x 3" x 40"		3.5 lbs.
	3" x 3" x 48"		4.2 lbs.
296	2" x 2" x 40"	Rounded	2.4 lbs.
	2" x 2" x 48"		2.8 lbs.
	3" x 3" x 40"		3.5 lbs.
	3" x 3" x 48"		4.2 lbs.

ASSA ABLOY
Opening Solutions

Experience a safer
and more open world

800-458-2424 | www.assaabloydooraccessories.us
Check the web site for the up-to-date catalog

Copyright © 2012-2020, ASSA ABLOY Accessories and Door Controls Group, Inc. All rights reserved. Reproduction in whole or in part without the express written permission of ASSA ABLOY Accessories and Door Controls Group, Inc. is prohibited.



Latch Protector No. 320-RKW

- Material:** .105" steel, stainless steel
- Finishes:** US2C (cadmium plated), US32D, and US10BE
- Fastener:** $\frac{5}{16}$ " - 18 carriage bolts and hex drive sex nuts
- Ordering:** Specify product number and finish
- Features:** Jamb pin prevents prying of door. Non-handed

No.	Material Size	Lock Type	Weight
320-RKW	3" x 11"	Cylindrical or mortise	1.2 lbs.

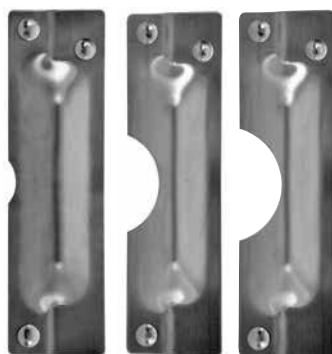

320C

320CL

320CXL

Latch Protectors No. 320C, 320CL, 320CXL

- Material:** .090" steel, stainless steel
- Finishes:** US2C (cadmium plated), US32D, and US10BE
- Fastener:** $\frac{5}{16}$ " - 18 carriage bolts and hex drive sex nuts
- Ordering:** Specify product number and finish
- Features:** Jamb pin prevents prying of door. Non-handed
 No. 320C: Notched for $2\frac{1}{8}$ " or less diameter rose on cylindrical lockset
 No. 320CL: Notched for $2\frac{1}{4}$ " - $3\frac{1}{4}$ " diameter rose on cylindrical lockset
 No. 320CXL: Notched for $2\frac{1}{4}$ " - $3\frac{3}{4}$ " diameter rose on cylindrical lockset

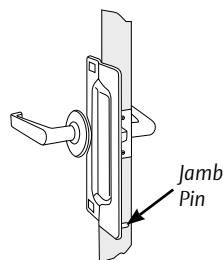

No.	Material Size	Lock Type	Weight
320C	3" x 11"	Cylindrical	1.2 lbs.
320CL	3" x 11"	Cylindrical	1.2 lbs.
320 CXL	3" x 11"	Cylindrical	1.2 lbs.



Latch Protector No. 321

- Material:** .105" steel, stainless steel
- Finishes:** US2C (cadmium plated), US32D, and US10BE
- Fastener:** $\frac{5}{16}$ " - 18 carriage bolts and hex drive sex nuts
- Ordering:** Specify product number and finish

No.	Material Size	Lock Type	Weight
321	$1\frac{1}{2}$ " x 10"	Mortise	0.7 lbs.



Latch Protector No. 322

- Material:** .100" steel, stainless steel
Finishes: US2C (cadmium plated), US32D, and US10BE
Fastener: $\frac{5}{16}$ - 18 carriage bolts and hex drive sex nuts
Ordering: Specify product number and finish
Features: Compact size. Non-handed

No.	Material Size	Lock Type	Weight
322	1 $\frac{5}{8}$ " x 6"	Cylindrical	5.6 oz.



Cast Latch Protector No. 325

- Material:** .375" solid cast brass
Finishes: US26D
Fastener: $\frac{1}{4}$ - 20 thru bolts & finish washer
Ordering: Specify product number and finish
Features: Clean aesthetic design with no exposed fasteners

No.	Material Size	Lock Type	Weight
325	1 $\frac{7}{8}$ " x 9 $\frac{1}{2}$ "	Mortise or cylindrical	1.1 lbs.



Anti-Vandal Latch Protector No. 330

- Material:** .090" stainless steel
Finishes: US32D
Fastener: #8 x $\frac{3}{4}$ " FH stainless steel combo screws
Ordering: Specify product number and finish
Features:
 - Protects cylindrical locks from forced entry and vandalism
 - Fast and simple installation
 - Non-handed
 - Attractive appearance

No.	Material Size	Lock Type	Weight
330	5 $\frac{3}{8}$ " x 6"	Cylindrical	1.8 lbs.

ASSA ABLOY
Opening Solutions

Experience a safer
and more open world

800-458-2424 | www.assaabloydooraccessories.us
Check the web site for the up-to-date catalog

Copyright © 2012-2020, ASSA ABLOY Accessories and Door Controls Group, Inc. All rights reserved. Reproduction in whole or in part without the express written permission of ASSA ABLOY Accessories and Door Controls Group, Inc. is prohibited.



Solid Cast Wall Stops No. 400, 401, 402

Material: Cast brass with rubber bumper

Finishes: Available in standard architectural finishes (see page 9)

Features: Concealed mounting, convex bumper.

No.	Bumper	Fastener	Size	Projection	Weight	ANSI A156.16
400	Convex	#6 x 1 1/2" FH SMS, plastic toggle	2 7/16" dia.	1"	2 lbs./10	L02101
401	Convex	#8 x 1" RH WS, plastic anchor	2 7/16" dia.	1"	2 lbs./10	L02101
402	Convex	#8 - 32 x 1" TH MS, anchor	2 7/16" dia.	1"	2 lbs./10	L02101



Solid Cast Wall Stops No. 403, 404, 405

Material: Cast brass with rubber bumper

Finishes: Available in standard architectural finishes (see page 9)

Features: Concealed mounting, concave bumper.

No.	Bumper	Fastener	Size	Projection	Weight	ANSI A156.16
403	Concave	#6 - 1 1/2" FH SMS, plastic toggle	2 7/16" dia.	1"	2 lbs./10	L02251
404	Concave	#8 x 1" RH WS, plastic anchor	2 7/16" dia.	1"	2 lbs./10	L02251
405	Concave	#8 - 32 x 1" TH MS, anchor	2 7/16" dia.	1"	2 lbs./10	L02251



Wrought Wall Stops No. 406

Material: Wrought brass, bronze, and stainless steel with rubber bumper

Finishes: Available in standard architectural finishes (see page 9)

Features:

- Concealed mounting, convex bumper. Back plate prevents damage to wall
- Accepted by the New York State Office of Mental Health (OMH) for use in high risk areas

No.	Bumper	Fastener	Size	Projection	Weight	ANSI A156.16
406	Convex	#8 x 1 1/4" TH SMS, plastic toggle	2 1/2" dia.	1"	1 1/4 lbs./10	L02101



Wrought Wall Stops No. 409

Material: Wrought brass, bronze, and stainless steel with rubber bumper

Finishes: Available in standard architectural finishes (see page 9)

Features:

- Concealed mounting, concave bumper. Back plate prevents damage to wall
- Accepted by the New York State Office of Mental Health (OMH) for use in high risk area

Options: Rubber bumper available in standard gray or optional black

No.	Bumper	Fastener	Size	Projection	Weight	ANSI A156.16
409	Concave	#8 x 1 1/4" TH SMS, plastic toggle	2 1/2" dia.	1"	1 1/4 lbs./10	L02251



Solid Cast Wall Stop No. 412

- Material:** Cast brass with rubber bumper
- Finishes:** Available in standard architectural finishes (see page 9)
- Features:** For where concealed mounting is not desired. School version
- Options:** Tamperproof Torx screws

No.	Bumper	Fastener	Size	Projection	Weight	ANSI A156.16
412	Convex	#8 x 1 ³ / ₄ " FH SMS	2 ⁷ / ₁₆ " dia.	1"	3.5 lbs./10	L12111



Solid Cast Wall Stop No. 415

- Material:** Cast brass with rubber bumper
- Finishes:** Available in standard architectural finishes (see page 9)
- Features:** Large size with flush back plate spreads impact of heavy or uncontrolled door contact — avoiding damage to wall. Universal screw pack is included for all wall conditions

No.	Bumper	Fastener	Size	Projection	Weight	ANSI A156.16
415	Convex	1 - #8 - 32 x 2" RH MS and toggle bolt	4" dia.	3/4"	10 oz. each	L02111
		1 - #12 - 24 x 1 ¹ / ₄ " RH MS and anchor				
		3 - #8 x 1 ¹ / ₄ " FH SMS and plastic anchors				
		3 - #8 - 32 x 1 ¹ / ₄ " FH MS				



Solid Cast Wall Stop No. 416

- Material:** Cast brass with rubber bumper
- Finishes:** Available in standard architectural finishes (see page 9)
- Features:** For use where concealed mounting is not desired. School version
- Options:** Tamperproof Torx screws

No.	Bumper	Fastener	Size	Projection	Weight	ANSI A156.16
416	Concave	#8 x 1 ³ / ₄ " FH SMS	2 ⁷ / ₁₆ " dia.	1"	3.5 lbs./10	L12261



Wrought Wall Stop No. 426

Material: Wrought brass and stainless steel with rubber bumper

Finishes: US3, US32D

Other: Concealed mounting

No.	Bumper	Fastener	Size	Projection	Weight	ANSI A156.16
426	Concave	#8 x 1 ¹ / ₄ " TH SMS, plastic toggle and plastic anchor	1 ⁷ / ₈ " dia.	1"	1 lbs./10	L02251



Solid Cast Wall Stop No. 430-RKW

Material: Solid brass with rubber bumper

Finishes: Available in standard architectural finishes (see page 9)

Features:

- Compact design for use on hotel bathroom doors swinging into the tub area, or where an inconspicuous bumper is desired.
- Concealed mounting

No.	Bumper	Fastener	Size	Projection	Weight	ANSI A156.16
430-RKW	Convex	#6 x ³ / ₄ " OH SMS, plastic anchor	1" dia	⁷ / ₁₆ "	0.5 lbs./10	L02101



Wall Stop No. 431-RKW

Material: Gray rubber bumper

Finishes: Gray

Features: Economical bumper for applications where a completely concealed mounting is not required

No.	Bumper	Fastener	Size	Projection	Weight	ANSI A156.16
431-RKW	Concave	#8 x 1 ¹ / ₄ " TH SMS, #8 flat washer, plastic toggle	1 ⁹ / ₁₆ " dia.	¹⁵ / ₁₆ "	1.0 lbs./10	—



Wall Stop No. 432W

Material: White rubber bumper

Finishes: White

Features:

- Economical
- Self-adhesive mounting

No.	Bumper	Fastener	Size	Projection	Weight	ANSI A156.16
432W	Concave	Self-adhesive tape	1 ⁹ / ₁₆ " dia.	³ / ₄ "	5 oz./10	—



Low Dome Stops No. 440, 441

- Material:** Solid cast brass with rubber bumper
- Finishes:** Available in standard architectural finishes (see page 9)
- Other:** No. 441 is packed with both WS and MS fasteners
- Features:** For doors without thresholds (not undercut).
- Options:** Exterior pack screw packs, stainless steel plated to match — use EXP suffix (440 x EXP) when ordering.

No.	Fastener	Base	Height	Weight	ANSI A156.16
440	#12 x 1 ¹ / ₄ " FH WS, plastic anchor	¹ / ₄ " h x 1 ⁷ / ₈ " dia.	1 ¹ / ₈ "	1.5 lbs./10	L02141
441	#12 x 1 ¹ / ₂ " FH WS, plastic anchor; #12 - 24 x 1 ¹ / ₂ " FH MS, anchor	¹ / ₄ " h x 1 ⁷ / ₈ " dia.	1 ¹ / ₈ "	2.1 lbs./10	L02141



Dome Stop Combination Unit No. 441CU

- Material:** Solid cast brass with rubber bumper
- Finishes:** Available in standard architectural finishes (see page 9)
- Other:** Set consists of 1 each No. 441 and 1 each No. 444. For use at doors with or without a threshold
- Features:** Convertible for undercut or not undercut doors
- Options:** Exterior pack screw packs, stainless steel plated to match — use EXP suffix (441CU x EXP) when ordering

No.	Fastener	Base	Height	Weight	ANSI A156.16
441CU	#12 x 1 ¹ / ₂ " FH WS, plastic anchor; #12 - 24 x 1 ¹ / ₂ " FH MS, anchor	Dome stop: ¹ / ₄ " h x 1 ⁷ / ₈ " dia. Riser: ³ / ₈ " h x 2" dia.	1 ¹ / ₈ " or 1 ¹ / ₂ "	1.85 lbs./10	L02141/ L02161
444	Cast riser only	³ / ₈ " h x 1 ³ / ₄ " dia.	³ / ₈ "	10 oz. /10	L02141

ASSA ABLOY
Opening Solutions

Experience a safer
and more open world

800-458-2424 | www.assaabloydooraccessories.us
Check the web site for the up-to-date catalog

Copyright © 2012-2020, ASSA ABLOY Accessories and Door Controls Group, Inc. All rights reserved. Reproduction in whole or in part without the express written permission of ASSA ABLOY Accessories and Door Controls Group, Inc. is prohibited.



Cast Universal Dome Stop No. 441H

- Material:** Solid cast brass with rubber bumper
- Finishes:** Available in standard architectural finishes (see page 9)
- Features:** Low lip dome stop with height of high dome stop, eliminates the need to determine requirement for traditional low or high dome stop — one stop for all applications. Integral cast pin for added strength. Universal screw pack included for all floor conditions
- Options:** Exterior pack screw packs, stainless steel plated to match — use EXP suffix (441HxEXP) when ordering.

No.	Fastener	Base	Height	Weight	ANSI A156.16
441H	#12 x 1 ¹ / ₄ " FH WS, plastic anchor	⁷ / ₃₂ " h x 1 ⁷ / ₈ " dia.	1 ¹¹ / ₁₆ "	3.2 lbs./10	L02141
	#12 - 24 x 1" FH MS, anchor				L02161



High Dome Stops No. 442, 443

- Material:** Solid cast brass with rubber bumper
- Finishes:** Available in standard architectural finishes (see page 9)
- Other:** No. 443 is packed with both WS and MS fasteners
- Features:** For doors with thresholds or undercut doors
- Options:** Exterior pack screw packs, stainless steel plated to match — use EXP suffix (442 x EXP) when ordering.

No.	Fastener	Base	Height	Weight	ANSI A156.16
442	#12 x 1 ¹ / ₂ " FH WS, plastic anchor	¹ / ₂ " h x 1 ⁷ / ₈ " dia.	1 ¹ / ₂ "	2.8 lbs./10	L02161
443	#12 x 1 ¹ / ₂ " FH WS, plastic anchor; #12 - 24 x 1" FH MS, anchor	¹ / ₂ " h x 1 ⁷ / ₈ " dia.	1 ¹ / ₂ "	3.2 lbs./10	L02161



No. 445



No. 445H

Heavy Duty Door Stop No. 445, 445H

- Material:** Solid cast brass with rubber bumper
- Finishes:** Available in standard architectural finishes (see page 9)
- Features:** Extra heavy duty dome type stop for heavy and high frequency doors
- Options:** Exterior pack screw packs, stainless steel plated to match — use EXP suffix (445 x EXP) when ordering.

No.	Fastener	Base	Height	Weight
445	2 ea. #12 x 1 ¹ / ₂ " FH SMS, plastic anchor; #12 - 24 x 1" FH MS, anchor	2" x 4"	1 ¹ / ₈ "	4.6 lbs./10
445H	2 ea. #12 x 1 ¹ / ₂ " FH SMS, plastic anchor; #12 - 24 x 1" FH MS, anchor	2" x 4"	1 ¹¹ / ₁₆ "	6 lbs./10



Door Stop Riser No. 449

- Material:** Aluminum
- Finishes:** Mill aluminum or painted to match
- Ordering:** Specify finish and thickness; 1/4", 3/8", 1/2", 5/8", 3/4", 1"
- Other:** Full size carpet riser provides sturdy base for mounting the No. 440 or No. 442 dome stop

No.	Fastener	Base	Height	Weight
449	#12 WS, plastic anchor	1 7/8" dia.	As specified	1.6 lbs./10



Door Stop No. 446

- Material:** Brass with rubber bumper.
- Finishes:** Available in standard architectural finishes (see page 9).
- Features:** Modern style universal stop.
- Options:** Rubber bumper available in standard gray or optional black.

No.	Fastener	Base	Height	Weight
446	#12 x 1 1/2" WS, plastic anchor; #12 - 24 x 1" FH MS, anchor	1 1/4"	1 1/2"	0.5 lbs.

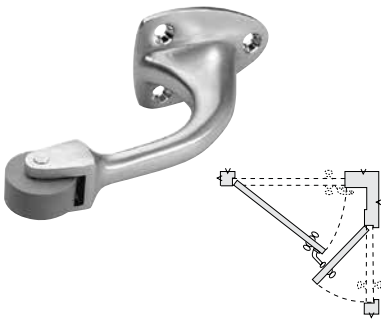

Curved Roller Stop No. 455

- Material:** Solid cast brass with rubber bumper
- Finishes:** Available in standard architectural finishes (see page 9)
- Features:** For use where doors swing into each other at odd angles

No.	Fastener	Base	Projection	Weight	ANSI A156.16
455	3 ea. #8 x 3/4" OH SMS	1 5/8" x 2 1/4"	2 3/4"	5 lbs./10	L02211

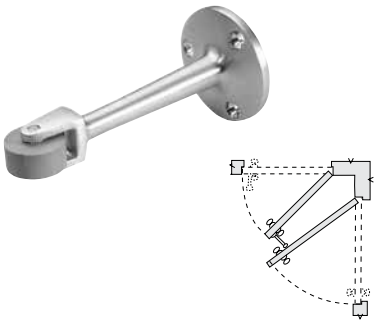

Straight Roller Stop No. 456-RKW

- Material:** Solid cast brass with rubber bumper
- Finishes:** Available in standard architectural finishes (see page 9)
- Features:** For use where doors swing into each other at right angles

No.	Fastener	Base	Projection	Weight	ANSI A156.16
456-RKW	3 ea. #8 x 3/4" OH SMS	2" dia.	4 9/16"	4.1 lbs./10	L02191

ASSA ABLOY
Opening Solutions

Experience a safer
and more open world

800-458-2424 | www.assaabloydooraccessories.us
Check the web site for the up-to-date catalog

Copyright © 2012-2020, ASSA ABLOY Accessories and Door Controls Group, Inc. All rights reserved. Reproduction in whole or in part without the express written permission of ASSA ABLOY Accessories and Door Controls Group, Inc. is prohibited.



Straight Roller Stop No. 456L

- Material:** Solid cast brass with rubber bumper
- Finishes:** Available in standard architectural finishes (see page 9)
- Features:** For use where doors swing into each other at right angles

No.	Fastener	Base	Projection	Weight	ANSI A156.16
456L	3 ea. #8x ³ / ₄ " OH SMS	2" dia.	6 ¹ / ₄ "	4.8 lbs./10	L02191



Kick Down Door Stop No. 458

- Material:** Cast zinc with rubber bumper
- Finishes:** Available in bright brass (BRS), dull bronze (BRZ), and bright chrome plate (CRM)
- Features:**
- Uses replacement bumper No. 461B
 - Rubber bumper provides reliable grip on floor.

No.	Fastener	Base	Projection	Weight	ANSI A156.16
458	3 ea. #8x1" OH SMS	1 ⁵ / ₈ " x 1 ⁷ / ₈ "	4"	3.3 lbs./10	L01382



Spring Loaded Plunger Stop No. 459

- Material:** Solid cast brass with rubber bumper
- Finishes:** Available in standard architectural finishes (see page 9)
- Features:**
- Uses replacement bumper No. 461B
 - Foot operated, spring loaded
 - Rubber bumper provides reliable grip on floor

No.	Fastener	Base	Projection	Weight	ANSI A156.16
459	3 ea. #8x ³ / ₄ " OH SMS	1 ³ / ₈ " x 5 ³ / ₈ "	1 ⁷ / ₈ "	4.7 lbs./10	L01411



Kick Down Door Stop No. 460

- Material:** Solid cast aluminum with rubber bumper
- Finishes:** Spray painted silver (ALM), brass (BRS), bronze (BRZ) or brown to match US10B (ORB)
- Features:**
- Uses replacement bumper No. 461B
 - Rubber bumper provides reliable grip on floor.

No.	Fastener	Base	Projection	Weight	ANSI A156.16
460	4 ea. #8x1" FH SMS	2 ¹ / ₁₆ " x 1 ³ / ₈ "	4"	2.7 lbs./10	L01382



Kick Down Door Stop No. 461

- Material:** Solid cast brass with rubber bumper
- Finishes:** Available in standard architectural finishes (see page 9)
Rubber bumper available in gray or black
- Features:**
- Uses replacement bumper No. 461B
 - Rubber bumper provides reliable grip on floor
 - A unique assembly design that conceals the axle in the base

No.	Fastener	Base	Projection	Weight	ANSI A156.16
461	4 ea. #8 x 3/4" OH SMS	2 1/4" x 1 1/4"	3 5/8"	5.1 lbs./10	L01382



Kick Down Door Stop No. 461L

- Material:** Solid cast brass with rubber bumper
- Finishes:** Available in standard architectural finishes (see page 9).
Rubber bumper available in gray or black
- Features:**
- Uses replacement bumper No. 461B
 - Rubber bumper provides reliable grip on floor
 - A unique assembly design that conceals the axle in the base
 - For use with doors up to 3" door-to-floor clearance

No.	Fastener	Base	Projection	Weight	ANSI A156.16
461L	4 ea. #8 x 3/4" OH SMS	2 1/4" x 1 1/4"	5"	5.7 lbs./10	L01382

ASSA ABLOY
Opening Solutions

Experience a safer
and more open world

800-458-2424 | www.assaabloydooraccessories.us
Check the web site for the up-to-date catalog

Copyright © 2012-2020, ASSA ABLOY Accessories and Door Controls Group, Inc. All rights reserved. Reproduction in whole or in part without the express written permission of ASSA ABLOY Accessories and Door Controls Group, Inc. is prohibited.



Heavy Duty Door Stop No. 462

- Material:** Flame resistant high impact bumper
Finishes: US2C
Mounting: Drill 1" dia. x 2 1/2" deep hole, fill with anchoring grout

No.	Diameter	Height	Mounting Bolt	Weight
462	2" dia.	x 1 1/2" h	5/8" x 2 1/2"	0.6 lbs.



Heavy Duty Door Stop No. 463-RKW

- Material:** Flame resistant high impact bumper
Finishes: US32D
Mounting: Drill 1" dia. x 2 1/2" deep hole, fill with anchoring grout
Other: Replaceable bumper retained by security Torx MS

No.	Diameter	Height	Mounting Bolt	Weight
463-RKW	2" dia.	x 1 3/4" h	1/2" x 2 1/2"	0.5 lbs.



Heavy Duty Door Stop with Holder No. 464-RKW

- Material:** Cast brass and black rubber bumper
Finishes: US26D
Mounting: Body: 1 ea. 1/2 x 4 1/2" lag bolt; 1 ea. shield;
 2 ea. #8 x 1 1/4" FH SMS.
 Cap: 1 ea. #8 - 32 x 3/8" RH MS
Features: Offers maximum protection needed for heavily used doors.
 Supplied with holder and catch

No.	Diameter	Height	Weight
464-RKW	3 1/4" dia.	x 3" h	1.8 lbs.



Heavy Duty Door Stop No. 465

- Material:** Wrought brass and black rubber bumper
Finishes: US26D
Mounting: Body: 1 ea. 1/2 x 4 1/2" lag bolt; 1 ea. shield.
 Cap: 1 ea. #8 - 32 x 3/8" RH MS
Features: Offers maximum protection needed for heavily used doors

No.	Diameter	Height	Weight
465	3 1/4" dia.	x 2 5/8" h	1.3 lbs.



Heavy Duty Door Stop No. 466-RKW

- Material:** Flame resistant molded rubber bumper
- Finishes:** Black
- Mounting:** Drill 1" dia. x 2 1/2" deep hole, fill with anchoring grout
- Features:**
- Ideal for use in high vandalism or security areas
 - No exposed fasteners

No.	Diameter	Height	Mounting Bolt	Weight
466-RKW	2" dia.	x 1 1/2" h	5/8" x 2 1/2"	0.6 lbs.



Heavy Duty Door Stop No. 467-RKW

- Material:** Flame resistant molded rubber bumper
- Finishes:** Black
- Mounting:** Drill 1" dia. x 2 1/2" deep hole, fill with anchoring grout
- Features:**
- Suitable for concrete floor or wall mounting
 - Ideal for use in high vandalism or security areas
 - No exposed fasteners
 - Accepted by the New York State Office of Mental Health (OMH) for use in high risk areas

No.	Diameter	Height	Mounting Bolt	Weight
467-RKW	2" dia.	x 3 1/2" h	5/8" x 2 1/2"	0.9 lbs.



Heavy Duty Door Stop No. 468-RKW

- Material:** Wrought stainless steel and black rubber bumper
- Finishes:** US32D
- Mounting:** Drill 1 1/2" dia. x 7" deep hole, fill with anchoring grout
- Features:**
- Ideal for use in high vandalism or security area
 - No exposed fasteners
 - Accepted by the New York State Office of Mental Health (OMH) for use in high risk areas

No.	Diameter	Height	Mounting Bolt	Weight
468-RKW	2" dia.	x 3" h	1" x 7"	2.6 lbs.

ASSA ABLOY
Opening Solutions

Experience a safer
and more open world

800-458-2424 | www.assaabloydooraccessories.us
Check the web site for the up-to-date catalog

Copyright © 2012-2020, ASSA ABLOY Accessories and Door Controls Group, Inc. All rights reserved. Reproduction in whole or in part without the express written permission of ASSA ABLOY Accessories and Door Controls Group, Inc. is prohibited.



No. 471

Door Stops No. 470, 471

- Material:** Cast brass with rubber bumper
- Finishes:** Available in standard architectural finishes (see page 9)
- Options:** Exterior pack screw packs, stainless steel plated to match — use EXP suffix (470xEXP) when ordering

No.	Fastener	Base	Height	Weight	ANSI A156.16
470	3 ea. #12 x 1 ¹ / ₄ " FH WS; 3 ea. plastic anchors	2 ¹ / ₂ " dia.	3"	0.7 lbs.	L02121
471	1 ea. ⁵ / ₁₆ - 18 x 1 ³ / ₄ " stud, anchor; #8 x ³ / ₄ " OH SMS, plastic anchor	2 ¹ / ₂ " dia.	3"	0.7 lbs.	L02131



No. 473

Door Stops with Keepers No. 472, 473

- Material:** Cast brass with rubber bumper
- Finishes:** Available in standard architectural finishes (see page 9)
- Other:** Keeper size 1" w x 1³/₄" h
- Options:** Exterior pack screw packs, stainless steel plated to match — use EXP suffix (472 x EXP) when ordering

No.	Fastener	Base	Height	Weight	ANSI A156.16
472	3 ea. #12 x 1 ¹ / ₄ " FH WS; 3 ea. plastic anchors Keeper: 2 ea. #12 x 1 ¹ / ₄ " FH WS; 2 ea. plastic anchors	2 ¹ / ₂ " dia.	3 ³ / ₄ "	0.9 lbs.	L01361
473	⁵ / ₁₆ - 18 x 1 ³ / ₄ " stud, anchor; #8 x ³ / ₄ " OH SMS, plastic anchor Keeper: 2 ea. #12 x 1 ¹ / ₄ " FH WS; 2 ea. plastic anchors	2 ¹ / ₂ " dia.	3 ³ / ₄ "	0.9 lbs.	L01371

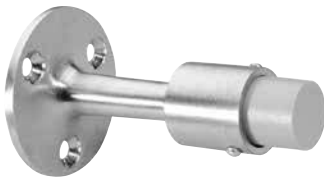

No. 474

Door Stops No. 474, 475

Material: Cast brass with rubber bumper

Finishes: Available in standard architectural finishes (see page 9)

No.	Fastener	Base	Projection	Weight	ANSI A156.16
474	3 ea. #12 x 1 ¹ / ₄ " FH WS, 3 ea. plastic anchors	2 ¹ / ₄ " dia.	3 ³ / ₄ "	0.6 lbs.	L02011
475	1 ea. ⁵ / ₁₆ " - 18 x 1 ³ / ₄ " stud, anchor; #8 x ³ / ₄ " OH SMS, plastic anchor	2 ¹ / ₄ " dia.	3 ³ / ₄ "	0.6 lbs.	L02021



No. 476

Door Stops with Keepers No. 476, 477

Material: Solid cast brass with rubber bumper

Finishes: Available in standard architectural finishes (see page 9)

Other: Keeper size 1"wx1³/₄"h

No.	Fastener	Base	Projection	Weight	ANSI A156.16
476	3 ea. #12 x 1 ¹ / ₄ " FH WS, 3 ea. plastic anchors Keeper: 2 ea. #12 x 1 ¹ / ₄ " FH WS; 2 ea. plastic anchors	2 ¹ / ₄ " dia.	3 ³ / ₄ "	0.8 lbs.	L01341
477	¹⁵ / ₁₆ " - 18 x 1 ³ / ₄ " stud, anchor; #8 x ³ / ₄ " OH SMS, plastic anchor Keeper: 2 ea. #12 x 1 ¹ / ₄ " FH WS; 2 ea. plastic anchors	2 ¹ / ₄ " dia.	3 ³ / ₄ "	0.8 lbs.	L01351

ASSA ABLOY
Opening Solutions

Experience a safer
and more open world

800-458-2424 | www.assaabloydooraccessories.us
Check the web site for the up-to-date catalog

Copyright © 2012-2020, ASSA ABLOY Accessories and Door Controls Group, Inc. All rights reserved. Reproduction in whole or in part without the express written permission of ASSA ABLOY Accessories and Door Controls Group, Inc. is prohibited.



Door Stops No. 481

- Material:** Solid cast brass with rubber bumper
- Finishes:** Available in standard architectural finishes (see page 9)
- Features:**
- Uses replacement bumper 461B
 - Heavy duty and ideal for use on heavy doors or in high traffic areas
- Options:**
- Rubber bumper available in standard gray or optional black
 - Exterior pack screw packs, stainless steel plated to match — use EXP suffix (480 x EXP) when ordering

No.	Fastener	Base	Height	Weight
481	3 ea. #12-24x1" FH MS, 3 ea. anchors	2 ¹ / ₂ " x 1 ³ / ₄ "	1 ⁵ / ₈ "	5.8 lbs./10



Door Stops No. 481H

- Material:** Solid cast brass with rubber bumper
- Finishes:** Available in standard architectural finishes (see page 9)
- Features:**
- Uses replacement bumper 461B
 - Heavy duty and ideal for use on heavy doors or in high traffic areas
- Options:**
- Rubber bumper available in standard gray or optional black
 - Exterior pack screw packs, stainless steel plated to match — use EXP suffix (480H x EXP) when ordering

No.	Fastener	Base	Height	Weight
481H	3 ea. #12-24x1" FH MS, 3 ea. anchors	2 ¹ / ₂ " x 1 ³ / ₄ "	2 ¹ / ₄ "	7.2 lbs./10



Heavy Duty Mounting Plate No. 481MP

- Material:** Aluminum and steel
- Finishes:** Powder coat to match stop finish
- Features:** ³/₈" aluminum base plate for securely anchoring 481 or 481H door stops in heavy use areas
- Requires ³/₂" diameter hole ³/₂" deep. Fill with quick drying cement and set anchor plate flush to finished floor with hole pattern at appropriate location for door stop to interface with door surface

No.	Fastener	Base	Height	Weight
481MP	None	3" dia	Flush to floor	4.5 lbs./10



Door Stop No. 482

- Material:** Solid cast brass with rubber bumper
- Finishes:** Available in standard architectural finishes (see page 9)
- Features:**
- Uses replacement bumper 461B
 - Heavy duty and ideal for use on heavy doors or in high traffic areas
- Options:**
- Rubber bumper available in standard gray or optional black.
 - Exterior pack screw packs, stainless steel plated to match — use EXP suffix (482 x EXP) when ordering.

No.	Fastener	Base	Height	Weight	ANSI A156.16
482	$\frac{5}{16}$ - 18 x $1\frac{3}{4}$ " stud, anchor; #12 x $1\frac{1}{4}$ " FH WS, plastic anchor	$1\frac{1}{2}$ " x $2\frac{1}{2}$ "	$2\frac{1}{8}$ "	6.5 lbs./10	L02131



Door Stop No. 483

- Material:** Solid cast brass with rubber bumper
- Finishes:** Available in standard architectural finishes (see page 9)
- Features:**
- Uses replacement bumper 461B
 - Heavy duty and ideal for use on heavy doors or in high traffic areas
- Options:**
- Rubber bumper available in standard gray or optional black.
 - Exterior pack screw packs, stainless steel plated to match — use EXP suffix (483 x EXP) when ordering.

No.	Fastener	Base	Height	Weight	ANSI A156.16
483	$\frac{5}{16}$ - 18 x $1\frac{3}{4}$ " stud, anchor; #12 x $1\frac{1}{4}$ " FH WS, plastic anchor	$1\frac{5}{8}$ " x $2\frac{5}{8}$ "	$2\frac{3}{4}$ "	6.7 lbs./10	L02131



Door Stop with Keeper No. 485

- Material:** Solid cast brass with rubber bumper
- Finishes:** Available in standard architectural finishes (see page 9)
- Features:**
- Uses replacement bumper 461B
 - Heavy duty and ideal for use on heavy doors or in high traffic areas
- Options:**
- Rubber bumper available in standard gray or optional black
 - Exterior pack screw packs, stainless steel plated to match — use EXP suffix (485 x EXP) when ordering

No.	Fastener	Base	Height	Weight	ANSI A156.16
485	$\frac{5}{16}$ - 18 x $1\frac{3}{4}$ " stud, anchor; #12 x $1\frac{1}{4}$ " FH WS, plastic anchor Keeper: 2 ea. #10 x 1" FH SMS	$1\frac{5}{8}$ " x $2\frac{5}{8}$ " 1" x 2"	3"	7.8 lbs./10	L01371

ASSA ABLOY
Opening Solutions

Experience a safer
and more open world

800-458-2424 | www.assaabloydooraccessories.us
Check the web site for the up-to-date catalog

Copyright © 2012-2020, ASSA ABLOY Accessories and Door Controls Group, Inc. All rights reserved. Reproduction in whole or in part without the express written permission of ASSA ABLOY Accessories and Door Controls Group, Inc. is prohibited.



Angle Door Stop No. 486

- Material:** Steel with rubber bumper
Finishes: US2C
Features: For undercut doors up to 1 1/2"

No.	Fastener	Base	Height	Weight
486	2 ea. #12 x 1 1/2" FH SMS, 2 ea. plastic anchors	1" x 2 1/2"	2 5/8"	4 lbs./10



Heavy Duty Wall Stop No. 487

- Material:** Solid cast brass with rubber bumper
Finishes: US26D
Features: Sloping design resists vandalism

No.	Fastener	Base	Projection	Weight
487	3 ea. #10 x 1" FH SMS, 3 ea. plastic anchors	2 1/4" x 3"	3 3/4"	0.8 lbs.



Door Stop No. 488

- Material:** Solid brass
Finishes: Available in standard architectural finishes (see page 9)
Features: For single doors

No.	Fastener	Base	Height	Weight
488	2 ea. #12 x 1 1/2" FH WS, 2 ea. plastic anchors; 2 ea. #12 - 24 x 1" FH MS	1 1/2" x 2"	1"	2.2 lbs./10



Door Stop No. 489

- Material:** Solid brass
Finishes: Available in standard architectural finishes (see page 9)
Features: For single or pair of doors

No.	Fastener	Base	Height	Weight
489	4 ea. #12 x 1 1/2" FH WS, 4 ea. plastic anchors; 4 ea. #12 - 24 x 1" FH MS	3" x 2"	1"	4.1 lbs./10

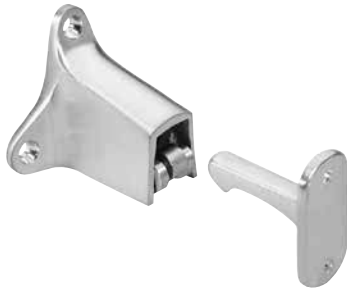

Door Holder with Stop No. 490

- Material:** Cast brass
- Finishes:** US26D
- Other:** Holder base: 2³/₄" w x 2¹/₂" h
Holder projection: 2¹/₈"
Strike base: 1" w x 2" h
Strike projection: 2"

No.	Fastener	Weight	ANSI A156.16
490	5 ea. #8 x 1" OH SMS, 3 ea. plastic anchors; 3 ea. #8 - 32 x 1 ¹ / ₄ " FH MS	0.8 lbs.	L01291



Automatic Door Holder with Stop No. 491-RKW, 491R, 491S

- Material:** Cast brass
- Finishes:** Available in standard architectural finishes (see page 9)
- Other:** Holder base: 3" w x 3³/₈" h
Holder projection: 2¹/₈"
Strike base: 4" w x 2" h
Strike projection: 1¹/₄"
- Options:** Strike risers available for larger clearances
- Features:**
- For applications requiring door hold-open on a frequent basis
 - Screw hole design allows for precise alignment and then permanent attachment

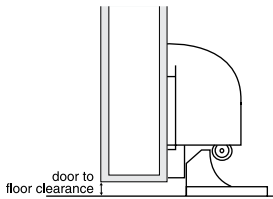

No.	Fastener	Strike	Clearance	Weight	ANSI A156.16
491-RKW	Strike: 3 ea. #12 x 1 ¹ / ₄ " FH WS, 3 ea. plastic anchors Body: 4 ea. #10 x 1 ¹ / ₄ " FH WS	Floor	1/2" or less door to floor	1.5 lbs.	L01301
491R	Strike: 3 ea. 12 - 24 x 1" FH MS, 3 ea. anchors Body: 4 ea. #10 x 1 ¹ / ₄ " FH WS	Floor	1/2" or less door to floor	1.5 lbs.	L01301
491S	Strike: 3 ea. 12 - 24 x 1" FH MS, 3 anchors Body: 4 ea. 10 - 24 x 1" FH MS; 4 ea. 10 - 24 x 1 ³ / ₈ " sex bolt	Floor	1/2" or less door to floor	1.5 lbs.	L01301

ASSA ABLOY
Opening Solutions

Experience a safer
and more open world

800-458-2424 | www.assaabloydooraccessories.us
Check the web site for the up-to-date catalog

Copyright © 2012-2020, ASSA ABLOY Accessories and Door Controls Group, Inc. All rights reserved. Reproduction in whole or in part without the express written permission of ASSA ABLOY Accessories and Door Controls Group, Inc. is prohibited.



Automatic Door Holder with Stop No. 494-RKW, 494R, 494S

Material: Cast brass

Finishes: Available in standard architectural finishes (see page 9)

Other: Holder base: 3" w x 3³/₈" h
Holder projection: 2¹/₈"
Strike base: 2" w x 3" h
Strike projection: 3¹/₄"

Features:

- For applications requiring door-hold-open on a frequent basis
- Screw hole design allows for precise alignment and then permanent attachment

No.	Fastener	Strike	Clearance	Weight	ANSI A156.16
494-RKW	Strike: 3 ea. #12 x 1 ¹ / ₄ " FH WS, 3 ea. plastic anchors Body: 4 ea. #10 x 1 ¹ / ₄ " FH WS	Wall	3 ³ / ₄ " wall to door	1.7 lbs.	L01291
494R	Strike: 3 ea. #12 - 24 x 1" FH MS, 3 ea. anchors Body: 4 ea. #10 x 1 ¹ / ₄ " FH WS	Wall	3 ³ / ₄ " wall to door	1.7 lbs.	L01291
494S	Strike: 3 ea. #12 - 24 x 1" FH MS, 3 ea. anchors Body: 4 ea. #10 - 24 x 1" FH MS; 4 ea. #10 - 24 x 1 ³ / ₈ " sex bolt	Wall	3 ³ / ₄ " wall to door	1.7 lbs.	L01291

NOTE: 494-RKW can be used as Foot Pull and Holder, see page B35.



Door Stops No. 505-RKW, 508

Material: Cast brass with rubber bumper

Finishes: Available in standard architectural finishes (see page 9).

Options: Rubber bumper available in standard white or optional gray and black

No.	Fastener	Base	Projection	Weight	ANSI A156.16
505-RKW	#10 - 24 x 1 1/4" hanger bolt	1" dia.	3 1/8"	1.6 lbs./10	L02031
508	#10 - 24 x 1 1/4" hanger bolt	1" dia.	4 3/16"	2.2 lbs./10	L02031



Aluminum Door Stop No. 517

Material: Cast aluminum with rubber bumper

Finishes: Bright brass (BRS) and burnished aluminum (ALM)

Options: Rubber bumper available in standard white or optional gray and black

No.	Fastener	Base	Projection	Weight	ANSI
517	2 ea. #8 x 3/4" OH SMS	1 1/2" dia.	3 3/4"	1.1 lbs./10	—



Door Stop No. 518

Material: Cast brass with rubber bumper

Finishes: Available in standard architectural finishes (see page 9)

Options: Rubber bumper available in standard white or optional gray and black

No.	Fastener	Base	Projection	Weight	ANSI
518	2 ea. #8 x 3/4" OH SMS	1 1/2" dia.	3 3/4"	1.9 lbs./10	—



Door Stop No. 519

Material: Cast brass with rubber bumper

Finishes: Available in standard architectural finishes (see page 9)

Options: Rubber bumper available in standard white or optional gray and black

No.	Fastener	Base	Projection	Weight	ANSI A156.16
519	#10 - 24 x 1 1/4" hanger bolt	1 1/4" dia.	3 1/4"	1.7 lbs./10	L02031



Replacement Bumper No. 520

Material: Rubber bumper

Weight: 0.7 lbs./10.

Other: Bumper replacement for No. 505, 508, 517, 518, 519.

Options: Available in standard white or optional gray and black.

ASSA ABLOY
Opening Solutions

Experience a safer
and more open world

800-458-2424 | www.assaabloydooraccessories.us

Check the web site for the up-to-date catalog

Copyright © 2012-2020, ASSA ABLOY Accessories and Door Controls Group, Inc. All rights reserved. Reproduction in whole or in part without the express written permission of ASSA ABLOY Accessories and Door Controls Group, Inc. is prohibited.



Spring Base Door Stop No. 525

Material: Spring steel

Finishes: Antique brass (ANT), bright brass (BRS), bright nickel (NP)

Features: Heavy spring construction for durable wear

No.	Fastener	Base	Projection	Weight	ANSI A156.16
525	6x ³ / ₄ " SMS	1" dia.	3"	0.7 lbs./10	L02051



Spring Base Door Stop No. 526

Material: Spring steel

Finishes: Bright brass (BRS), bright nickel (NP)

Features: Heavy spring construction for durable wear

No.	Fastener	Base	Projection	Weight	ANSI A156.16
526	6x ³ / ₄ " SMS	1" dia.	4"	0.8 lbs./10	L02061



Heavy Duty Hinge Pin Stop No. 528

Material: Wrought steel with rubber bumpers

Finishes: Antique brass (ANT), bright brass (BRS), bright nickel (NP)

Features:

- Positive slip proof adjustment
- Heavy wrought steel construction works with both ¹/₄" and ⁵/₁₆" hinge pins

No.	Door Opening Adjustment	Weight	ANSI A156.16
528	70° to 100°	1.3 lbs./10	L02223

Introduction to Overhead Stops & Holders

Rockwood Overhead Stops and Holders are used to extend the life of the door, frame and any door closing devices. They may be necessary if there are strong winds, high traffic or abuse.

- When used in conjunction with a floor closer, you have absolute door control, top and bottom.
- Provides positive deadstop at selected degree
- There are 2 functions, 3 ways to order:
 - Hold Open – door remains held open near deadstop location
 - Stops – door deadstops at a particular degree of opening
 - Multi Function – adaptable as hold open and/or stops
- Available as surface mounted or concealed
- Standard mount on push side of door (See model descriptions for pull side installations)
- Thru bolts are furnished with all surface models and must be used for installation

WARNING: HOLD OPEN FUNCTION CANNOT BE USED ON LABELED OPENINGS!

To Convert from Hold Open to Stop Function:

1. Remove the plastic end cap (#1) at the spring end of the channel.
2. With $\frac{3}{16}$ " hex key wrench, loosen the set screw in shock block.
3. Remove the shock block plate and the hold open spring from channel.
4. Remove the hold open spring from the shock block.
5. Replace the shock block and block plate into channel.
6. Replace the plastic end cap.
7. Install unit on door.
8. Adjust to desired opening and tighten set screw.

To Select Degree of Stop
(Hold Open Models):

1. Engage door in hold open position.
2. Using a $\frac{3}{16}$ " hex wrench, loosen the set screw in the shock block.
3. Open door to desired degree of opening.
4. Tighten set screw.
5. Verify door opening position and re-adjust, if needed.

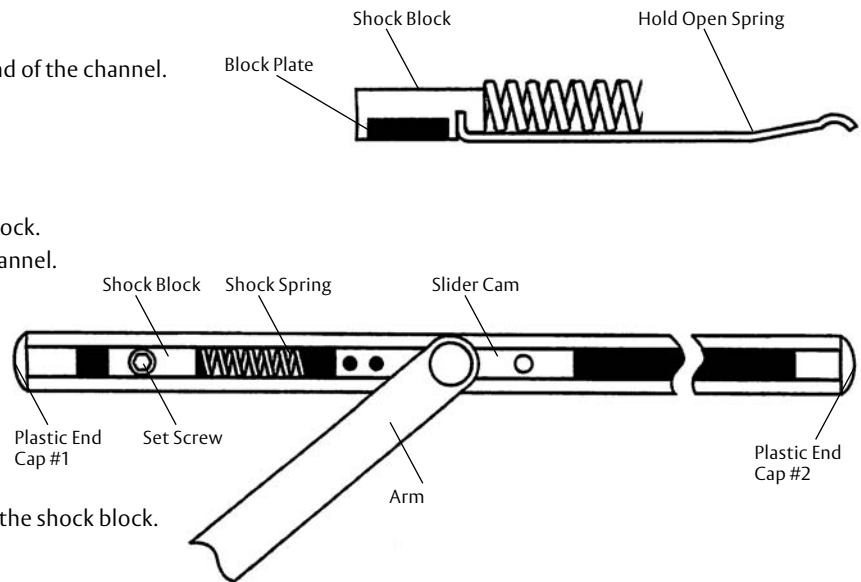

ASSA ABLOY
Opening Solutions

Experience a safer
and more open world

800-458-2424 | www.assaabloydooraccessories.us
Check the web site for the up-to-date catalog

Copyright © 2012-2020, ASSA ABLOY Accessories and Door Controls Group, Inc. All rights reserved. Reproduction in whole or in part without the express written permission of ASSA ABLOY Accessories and Door Controls Group, Inc. is prohibited.

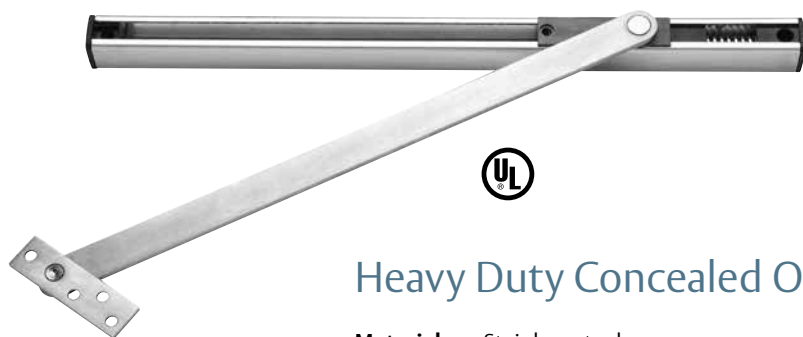

Heavy Duty Concealed OH100 Series

Material: Stainless steel

Finishes: US32D, US10B

Fasteners: Jamb: 1/4 -20 x 3/4" FH MS or #14 x 1 1/2" FH WS
Door: 5/16-18 x 1 1/2" FH MS or #18 x 3" FH WS

- Features:**
- Doors may be single or double acting
 - Non-handed
 - Slide track design
 - Recommended for high traffic, heavy abuse installations
 - Heavy shock absorber spring provides 5-7° compression before deadstop
 - Surface on/off knob on hold open models
 - Complete screw packet for installation in wood and machine screws for door and frame
 - For security areas, Torx® screws available for exposed fasteners.
 - Durable slider cam and shock block
 - 110° maximum opening
 - 1 3/4" minimum door thickness, for thicker doors, note thickness when ordering
 - 1 3/16" square channel
 - Stop function UL listed for fire door assemblies

Door Opening					
No.	Function	Butts/Offset Pivots	Center Hung	Weight	ANSI A156.8
OH101H	Hold open	24" - 28"	-	4.5 lbs.	C01511
OH102H	Hold open	28 1/16" - 33"	30" - 36"	4.5 lbs.	C01511
OH103H	Hold open	33 1/16" - 38"	36 1/16" - 41"	4.5 lbs.	C01511
OH104H	Hold open	38 1/16" - 43"	41 1/16" - 46"	4.5 lbs.	C01511
OH105H	Hold open	43 1/16" - 48"	46 1/16" - 50"	4.5 lbs.	C01511
OH101S	Stop only	24" - 28"	-	4.5 lbs.	C01541
OH102S	Stop only	28 1/16" - 33"	30" - 36"	4.5 lbs.	C01541
OH103S	Stop only	33 1/16" - 38"	36 1/16" - 41"	4.5 lbs.	C01541
OH104S	Stop only	38 1/16" - 43"	41 1/16" - 46"	4.5 lbs.	C01541
OH105S	Stop only	43 1/16" - 48"	46 1/16" - 50"	4.5 lbs.	C01541

800-458-2424 | www.assaabloydooraccessories.us

Check the web site for the up-to-date catalog

Copyright © 2012-2020, ASSA ABLOY Accessories and Door Controls Group, Inc. All rights reserved. Reproduction in whole or in part without the express written permission of ASSA ABLOY Accessories and Door Controls Group, Inc. is prohibited.

ASSA ABLOY
Opening Solutions

Experience a safer
and more open world



Standard Duty Concealed OH200 Series

Material: Stainless steel

Finishes: US32D, US10B

Fasteners: Jamb: #12-24 x 1/2" FH MS or #12 x 1 1/2" FH WS
Door: #12-24 x 1 1/2" FH MS or #12 x 1 1/2" FH WS

- Features:**
- Doors may be single or double acting
 - Non-handed
 - Slide track design
 - Recommended for medium traffic, medium weight doors
 - Degree of opening is fully adjustable and can be adapted to changing needs
 - Heavy shock absorber spring provides 5-7° compression before deadstop
 - Multi-function unit is shipped as a stop. Can be converted to a hold open or friction in the field. MF5012 KIT (Adapter kit) included
 - Complete screw packet kit for installation in wood or metal door and frame
 - For security areas, Torx® screws available for exposed fasteners, but heavy-duty units should be considered for high security applications
 - Durable slider cam and shock block
 - 110° maximum opening
 - 3/4" square channel
 - Stop function UL listed for fire door assemblies

Door Opening

No.	Function	Butts/Offset Pivots	Center Hung	Weight	ANSI A156.8
OH201S	Stop only	18" - 24"	–	3.5 lbs.	C04542
OH202S	Stop only	24 1/16" - 30"	27" - 32"	3.5 lbs.	C04542
OH203S	Stop only	30 1/16" - 36"	32 1/16" - 38 1/2"	3.5 lbs.	C04542
OH204S	Stop only	36 1/16" - 42"	38 9/16" - 45"	3.5 lbs.	C04542
OH205S	Stop only	42 1/16" - 48"	45 1/16" - 48"	3.5 lbs.	C04542
OH201M	Multi-function	18" - 24"	–	3.5 lbs.	–
OH202M	Multi-function	24 1/16" - 30"	27" - 32"	3.5 lbs.	–
OH203M	Multi-function	30 1/16" - 36"	32 1/16" - 38 1/2"	3.5 lbs.	–
OH204M	Multi-function	36 1/16" - 42"	38 9/16" - 45"	3.5 lbs.	–
OH205M	Multi-function	42 1/16" - 48"	45 1/16" - 48"	3.5 lbs.	–

ASSA ABLOY
Opening Solutions

Experience a safer
and more open world

800-458-2424 | www.assaabloydooraccessories.us
Check the web site for the up-to-date catalog

Copyright © 2012-2020, ASSA ABLOY Accessories and Door Controls Group, Inc. All rights reserved. Reproduction in whole or in part without the express written permission of ASSA ABLOY Accessories and Door Controls Group, Inc. is prohibited.



Heavy Duty Surface Mounted OH900 Series

Material: Stainless steel

Finishes: US32D, US10B

Fasteners: Jamb: $\frac{1}{4}$ -20 x $\frac{3}{4}$ " FH MS or #14 x $1\frac{1}{2}$ " FH WS
Door: $\frac{5}{16}$ -18 x 2" FH MS and $\frac{1}{2}$ " dia. sex bolt

- Features:**
- Doors are single acting
 - Non-handed
 - Slide track design
 - Recommended for high traffic, heavy abuse installations
 - Heavy shock absorber spring provides 5-7° compression before deadstop
 - On/off knob on hold open models
 - Complete screw packet with thru-bolts for door, wood and machine screws for frame
 - Torx® screws optional for security applications
 - Durable slider cam and shock block
 - 110° maximum opening
 - $1\frac{3}{4}$ " minimum door thickness
 - $1\frac{3}{16}$ " square channel
 - Stop function UL listed for fire door assemblies
 - For pull side mounting or flush mounting on push side or for rabbeted push side use angle jamb bracket adapter JB900LH or JB900RH

Door Opening

No.	Function	Butts/Offset Pivots	Center Hung	Weight	ANSI A156.8
OH901H	Hold open	24" - 28"	–	4.5 lbs.	C02511
OH902H	Hold open	28 $\frac{1}{16}$ " - 33"	30" - 36"	4.5 lbs.	C02511
OH903H	Hold open	33 $\frac{1}{16}$ " - 38"	36 $\frac{1}{16}$ " - 41"	4.5 lbs.	C02511
OH904H	Hold open	38 $\frac{1}{16}$ " - 43"	41 $\frac{1}{16}$ " - 46"	4.5 lbs.	C02511
OH905H	Hold open	43 $\frac{1}{16}$ " - 48"	46 $\frac{1}{16}$ " - 50"	4.5 lbs.	C02511
OH901S	Stop only	24" - 28"	–	4.5 lbs.	C02541
OH902S	Stop only	28 $\frac{1}{16}$ " - 33"	30" - 36"	4.5 lbs.	C02541
OH903S	Stop only	33 $\frac{1}{16}$ " - 38"	36 $\frac{1}{16}$ " - 41"	4.5 lbs.	C02541
OH904S	Stop only	38 $\frac{1}{16}$ " - 43"	41 $\frac{1}{16}$ " - 46"	4.5 lbs.	C02541
OH905S	Stop only	43 $\frac{1}{16}$ " - 48"	46 $\frac{1}{16}$ " - 50"	4.5 lbs.	C02541

800-458-2424 | www.assaabloydooraccessories.us

Check the web site for the up-to-date catalog

Copyright © 2012-2020, ASSA ABLOY Accessories and Door Controls Group, Inc. All rights reserved. Reproduction in whole or in part without the express written permission of ASSA ABLOY Accessories and Door Controls Group, Inc. is prohibited.

ASSA ABLOY
Opening Solutions

Experience a safer
and more open world



Standard Duty Surface Mounted OH1000 Series

Material: Stainless steel

Finishes: US32D, US10B

Fasteners: Jamb: #12 x 1 1/2" FH WS or #12-24 x 1/2" FH MS
Door: #12-24 x 1 1/2" FH MS and 5/16" dia. sex bolt

- Features:**
- Single acting doors
 - Non-handed
 - Slide track design
 - Recommended for medium traffic, medium weight doors
 - Degree of opening fully adjustable and can be adapted to changing needs
 - Heavy shock absorber spring provides compression before deadstop
 - Multi-function unit is shipped as a stop. Can be converted to a hold open or friction in field. MF5012 KIT (Adapter kit) included
 - Complete screw packet with thru-bolts for door, wood and machine screws for frame
 - Torx® screws optional for security applications, but heavy-duty units should be considered for high-security applications
 - Durable slider cam and shock block
 - 110° maximum opening
 - 3/4" square channel
 - Stop function UL listed for fire door assemblies
 - For pull side mounting or flush and rabbeted mounting on push side use angle jamb bracket adapter JB1000

Door Opening

No.	Function	Butts/Offset Pivots	Center Hung	Weight	ANSI A156.8
OH1001S	Stop only	18" - 24"	21" - 26 1/2"	3.5 lbs.	C05542
OH1002S	Stop only	24 1/16" - 30"	26 9/16" - 32"	3.5 lbs.	C05542
OH1003S	Stop only	30 1/16" - 36"	32 1/16" - 38"	3.5 lbs.	C05542
OH1004S	Stop only	36 1/16" - 42"	38 1/16" - 45"	3.5 lbs.	C05542
OH1005S	Stop only	42 1/16" - 48"	45 1/16" - 48"	3.5 lbs.	C05542
OH1001M	Multi-function	18" - 24"	21" - 26 1/2"	3.5 lbs.	-
OH1002M	Multi-function	24 1/16" - 30"	26 9/16" - 32"	3.5 lbs.	-
OH1003M	Multi-function	30 1/16" - 36"	32 1/16" - 38"	3.5 lbs.	-
OH1004M	Multi-function	36 1/16" - 42"	38 1/16" - 45"	3.5 lbs.	-
OH1005M	Multi-function	42 1/16" - 48"	45 1/16" - 48"	3.5 lbs.	-

ASSA ABLOY
Opening Solutions

Experience a safer
and more open world

800-458-2424 | www.assaabloydooraccessories.us
Check the web site for the up-to-date catalog

Copyright © 2012-2020, ASSA ABLOY Accessories and Door Controls Group, Inc. All rights reserved. Reproduction in whole or in part without the express written permission of ASSA ABLOY Accessories and Door Controls Group, Inc. is prohibited.



Lever Extension Flush Bolt No. 550

Material: Brass

Finishes: Available in standard architectural finishes (see page 9)

Fastener: 8 ea. #8 x 3/4" FH combo screws

Features:

- For Fire Rated Hollow Metal Swinging Doors measuring up to 4'w x 10'h rated up to and including 3 Hours
- 3/4" bolt throw, 3/4" rod backset
- 12" rod length (center of face to bolt end - retracted)
- 1 1/2" adjustable bolt head

Options:

- Other size rods available are 18", 24", 36", 48"
- Use No. 570 Dust Proof Strike (shown on page E4) to prevent dirt blocking bottom strike

No.	Size	Weight	ANSI A156.16
550	Face plate: 1 1/4" x 6 3/4" Strike: 1 5/16" x 2 1/4" Guide: 1" x 2"	1.7 lbs./2	L04251



Rabbit Piece No. 554

Material: Brass

Finishes: Available in standard architectural finishes (see page 9)

Fastener: 2 ea. #8 x 1 1/4" FH WS

Other: For use on rabbeted doors to fill mortise cut

No.	Size	Weight	ANSI A156.16
554	1/2" x 6 3/4"	4.1 lbs./10	W/555 L04101

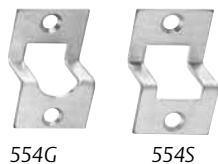

554G

554S

Rabbit Guides No. 554G, 554S

Material: Brass

Finishes: Brass

Fastener: 2 ea. #6 x 3/4" FH combo screws



Lever Extension Flush Bolt No. 555

Material: Brass

Finishes: Available in standard architectural finishes (see page 9)

Fastener: 8 ea. #8 x 3/4" FH combo screws

Features:

- For Fire Rated Hollow Metal Swinging Doors measuring up to 4'w x 10'h rated up to and including 3 Hours
- Fits ANSI A115 door and frame preparation
- 3/4" bolt throw, 3/4" rod backset
- 12" rod length (center of face to bolt end - retracted)
- 1 1/2" adjustable bolt head

Options:

- Other size rods available are 18", 24", 36", 48"
- Extra long bolt head - 2 1/2" (or to your specification)
- Use No. 570 Dust Proof Strike (shown on page E4) to prevent dirt blocking bottom strike

No.	Size	Weight	ANSI A156.16
555	Face plate: 1" x 6 3/4" Strike: 1 5/16" x 2 1/4" Guide: 1" x 2"	1.5 lbs./2	L04251



Lever Extension Flush Bolt with Bottom Fire Bolt No. 555 x 18BFB

Material: Flush bolt – brass
Bottom fire bolt – stainless steel

Finishes: Available in standard architectural finishes (see page 9)

Fastener: 8 ea. #8 x 3/4" FH combo screws

Features:

- For Fire Rated Hollow Metal Swinging Doors measuring up to 4'w x 9'h rated up to and including 3 Hours
- Fits ANSI A115 door and frame preparation
- 3/4" bolt throw, 3/4" rod backset
- 12" rod length (center of face to bolt end - retracted)
- 1 1/2" adjustable bolt head
- When door is subjected to 230°F the plug and black plastic cover will melt allowing the bolt to project, locking the leaves together
- Bottom fire bolt eliminates need for floor prep.
- Oversize fire bolt strike hole allows for slight door misalignment

Options:

- Other size rods available are 18", 24", 36", 48"
- Extra long bolt head – 2 1/2" (or to your specification)

No.	Size	Weight
555 x 18BFB	Top bolt: 1" x 6 3/4" Bottom bolt: 1 3/16" dia.	0.9 lbs.

ASSA ABLOY
Opening Solutions

Experience a safer
and more open world

800-458-2424 | www.assaabloydooraccessories.us
Check the web site for the up-to-date catalog

Copyright © 2012-2020, ASSA ABLOY Accessories and Door Controls Group, Inc. All rights reserved. Reproduction in whole or in part without the express written permission of ASSA ABLOY Accessories and Door Controls Group, Inc. is prohibited.



Lever Extension Flush Bolt No. 556WS Windstorm

The Rockwood 556WS Flush Bolt is part of a UL certified assembly from ASSA ABLOY. Listed for use on both in-swing or out-swing paired applications, the full assembly includes doors from Ceco Door, Curries or Fleming and latching hardware from Corbin Ruswin, SARGENT or Yale.

- Material:** Brass and Stainless Steel
- Finishes:** 26D or 32D.
- Fastener:** 8 ea. #8 - 32 x 1/4" FH MS in Stainless Steel
- Features:**
- 3/4" bolt throw, 3/4" rod backset
 - 12" Stainless Steel rod length (center of face to bolt end - retracted).
 - UL Certified
 - Tested to ASTM E330, E1886, E1996 and the TAS 201, 202, and 203. Assembly approved for use in the state of Florida including the High Velocity Hurricane Zone (HVHZ)

No.	Size	Material	Weight	ANSI A156.16
556WS	Face plate: 1" x 6 3/4" x 1/8" Mortise Body 1" x 5 1/4" x 1 3/8" Rod 12" x 1/2"D Strike: 1 5/16" x 2 1/4" Guide: 1" x 2"	Brass Brass Stainless Steel Stainless Steel Stainless Steel	2.5 lbs./2	L04251



Lever Extension Flush Bolt No. 557

- Material:** Cast brass
- Finishes:** Available in standard architectural finishes (see page 9)
- Fastener:**
- 7 ea. #8 x 3/4" FH combo screws
 - 4 ea. #8 - 32 x 1/2" FH MS
 - 4 ea. #8 counter sunk washer
- Features:**
- For Fire Rated Plastic & Wood Covered Doors measuring up to 4'w x 10'h rated up to and including 1 1/2 Hours
 - 3/4" bolt throw, 3/4" backset; door strength maintained by corner reinforcing plate
- Options:** Use No. 570 Dust Proof Strike (shown on page E4) to prevent dirt blocking bottom strike

No.	Size	Weight	ANSI A156.16
557	Face plate: 1" x 6 3/4" Strike: 1 5/16" x 2 1/4"	1.7 lbs./2	L04261

800-458-2424 | www.assaabloydooraccessories.us
Check the web site for the up-to-date catalog

Copyright © 2012-2020, ASSA ABLOY Accessories and Door Controls Group, Inc. All rights reserved. Reproduction in whole or in part without the express written permission of ASSA ABLOY Accessories and Door Controls Group, Inc. is prohibited.

ASSA ABLOY
Opening Solutions

Experience a safer
and more open world

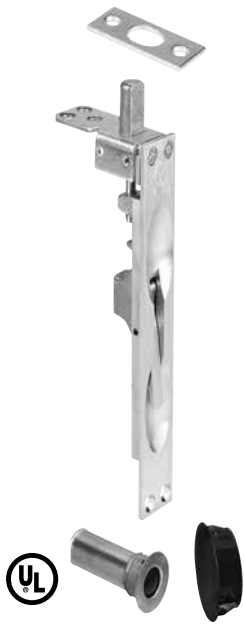

Lever Extension Flush Bolt With Bottom Fire Bolt No. 557 x 19BFB

Material: Flush bolt – brass
Bottom fire bolt – stainless steel

Finishes: Available in standard architectural finishes (see page 9)

Fastener: 7 ea. #8 x 3/4" FH combo screws
4 ea. #8 - 32 x 1/2" FH MS
4 ea. #8 counter sunk washer

Features:

- For Fire Rated Plastic & Wood Covered Fire Doors measuring up to 4'w x 9'h rated up to 20 minutes
- 3/4" bolt throw, 3/4" backset; door strength maintained by corner reinforcing plate
- When door is subjected to 230°F the plug and black plastic cover will melt allowing the bolt to project, locking the leaves together
- Bottom fire bolt eliminates need for floor prep
- Oversize fire bolt strike hole allows for slight door misalignment

No.	Size	Weight
557 x 19BFB	Top bolt: 1" x 6 3/4" Bottom bolt: 1 3/16" dia.	0.9 lbs.



Dust Proof Strike No. 570

Material: Brass

Finishes: Available in standard architectural finishes (see page 9)

Fastener: Adjustment nut
Spanner wrench
2 ea. #8 x 1 OH SMS, 2 ea. plastic anchors
2 ea. #8 - 32 x 3/4" OH MS, 2 ea. anchors

Features:

- Works with all Rockwood manual and automatic flush bolts
- Removable face plate for use with thresholds
- Adjustable height for carpeted areas

No.	Size	Weight	ANSI A156.16
570	Face plate: 1 3/8" x 2 7/8" Barrel: 3/4" dia. x 2" depth	0.4 lbs.	L04021

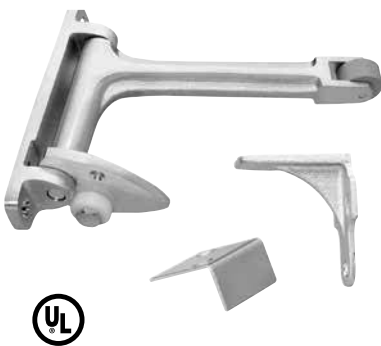

Gravity Door Coordinator No. 576

Material: Cast brass

Finishes: Available in standard architectural finishes (see page 9).

Fastener: Body: 2 ea. #10 x 1" FH SMS, 2 ea. #10 - 24 x 1" FH MS
Strike: 5 ea. #8 x 1" FH SMS

Other:

- For use on door sizes:
 - with Astragal on active door – 18" to 48"
 - with Astragal on inactive door – 18" to 34"
 - with Astragal on both doors – 18" to 30"
- The overlap of the astragal is maximum 7/8" with door hung on standard hinges. Customer must contact the factory for all other astragal situations

Features: Non-handed reversible. Prevents the active door from closing until the inactive door is closed

No.	Size	Projection	Weight	ANSI A156.3
576	1" x 5 7/16"	7"	2.2 lbs.	Type 21

ASSA ABLOY
Opening Solutions

Experience a safer
and more open world

800-458-2424 | www.assaabloydooraccessories.us

Check the web site for the up-to-date catalog

Copyright © 2012-2020, ASSA ABLOY Accessories and Door Controls Group, Inc. All rights reserved. Reproduction in whole or in part without the express written permission of ASSA ABLOY Accessories and Door Controls Group, Inc. is prohibited.

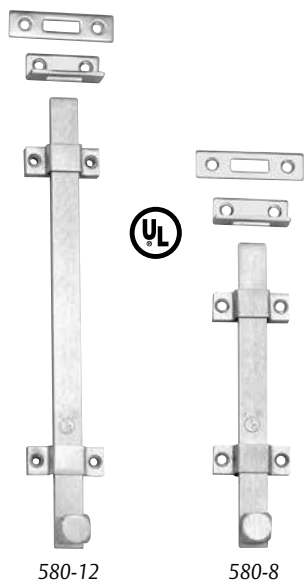

580-12

580-8

Surface Bolts No. 580, 582 Series

- Material:** No. 580: Steel, stainless steel
No. 582: Stainless steel
- Finishes:** US3, US10, US10B painted, US26D, US32D
- Fastener:** No. 580: 8 ea. #10x 1¹/₄" FH SMS, 8 ea. #10 - 24x 1" FH MS
No. 582: Bolt: 4 ea. #10 - 24x 1¹/₂" PH MS; 4 ea. #10x 1¹/₄" PH WS
Strikes: 6 ea. #10 - 32x 1¹/₂" FH MS; 6 ea. #10 - 32x 1¹/₂" FH WS
- Other:** 1¹/₈" bolt throw, 1¹/₄" x 3³/₄" bolt material
- Features:**
- No. 580 Series bolts are UL listed for use on inactive leaf of a pair of 3-hour labeled fire doors
 - No. 580 and No. 582 series both include a universal top strike and a mortise bottom strike
 - No. 582 Series has a bracket for padlock (padlock not included)
- Options:** Sex bolts available for extra secure mounting

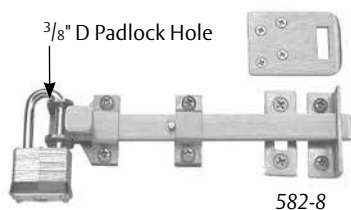

582-8

No.	Bolt Length	Weight	ANSI A156.16
580-8	8"	1.1 lbs.	L04161
580-12	12"	1.4 lbs.	L04161
580-18	18"	1.7 lbs.	L04161
580-24	24"	2.0 lbs.	L04161
582-8	8"	1.3 lbs.	
582-12	12"	1.6 lbs.	

Heavy Duty Surface Bolts No. 585 Series

- Material:** Steel
- Finishes:** US26D
- Fastener:** Bolt: 4 ea. 1¹/₄ - 20x 2¹/₄" FH MS
4 ea. 1¹/₄ - 20x 1⁵/₈" sex bolts
Strike: 2 ea. #14x 2¹/₂" FH SMS, 2 ea. Plastic Anchors
2 ea. 1¹/₄ - 20x 1" FH MS, 2 ea. 1¹/₄ - 20 Anchors
- Other:** 1¹/₄" bolt throw, 3³/₄" x 3³/₄" bolt material
- Features:**
- UL listed for use on inactive leaf of a pair of 3-hour labeled fire doors
 - Includes a universal top strike and a mortise bottom strike
 - Locks in both the up and down position
 - Bolt locks automatically when thrown – can be released only by pressing knob toward door while retracting
 - Can be used on any type of door
 - Accommodates padlock

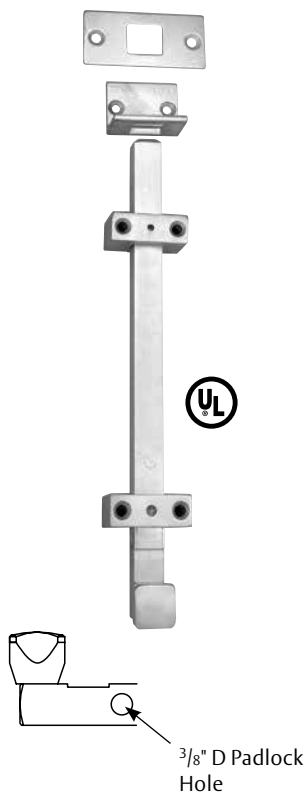

No.	Bolt Length	Weight	ANSI A156.16
585-12	12"	3.9 lbs.	L04161
585-24	24"	6.1 lbs.	L04161

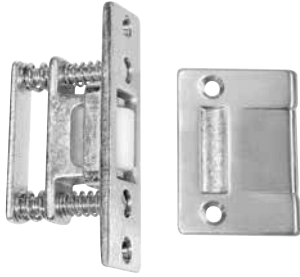

Roller Latch with Cast Strike No. 590

- Material:** Cast brass
- Finishes:** Available in standard architectural finishes (see page 9)
- Fastener:** Body: 2 ea. #8 x 3/4" FH combo screws
Strike: 2 ea. #8 x 3/4" FH combo screws
- Features:**
- Solid nylon roller for durable silent operation
 - Simple adjustment for roller projection

No.	Latch Face	Strike	Weight	ANSI A156.16
590	1" x 3 3/8"	1 11/16" x 2 1/4"	0.6 lbs.	E09091

Double Acting Strike No. 590DA

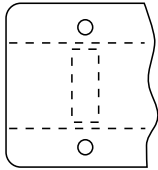

- Material:** Brass
- Finishes:** Available in standard architectural finishes (see page 9)
- Fastener:** Strike: 4 ea. #8 x 3/4" FH combo screws
- Other:** For use on double acting doors and frames with the No. 590
Specify size required
- Features:**
- Solid nylon roller for durable silent operation
 - Simple adjustment for roller projection

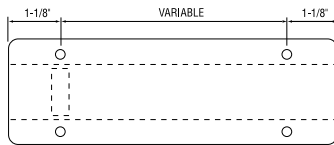

No.	Latch Face	Strike	Weight
590DA (Strike Only)	1" x 3 3/8"	2 3/4" x specify	0.6 lbs.

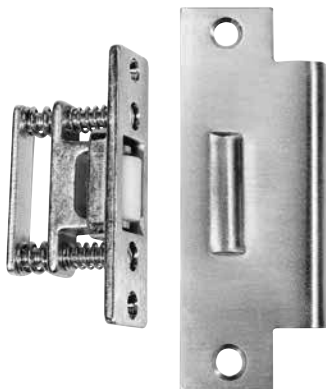

Roller Latch with ASA Strike No. 591

- Material:** Cast brass
- Finishes:** Available in standard architectural finishes (see page 9)
- Fastener:** Body: 2 ea. #8 x 3/4" FH combo screws
Strike: 2 ea. #12 - 24 x 1/2" FH MS
- Features:**
- Solid nylon roller for durable silent operation
 - Simple adjustment for roller projection

No.	Latch Face	Strike	Weight
591	1" x 3 3/8"	1 1/4 x 4 7/8"	0.6 lbs.

ASSA ABLOY
Opening Solutions

Experience a safer
and more open world

800-458-2424 | www.assaabloydooraccessories.us
Check the web site for the up-to-date catalog

Copyright © 2012-2020, ASSA ABLOY Accessories and Door Controls Group, Inc. All rights reserved. Reproduction in whole or in part without the express written permission of ASSA ABLOY Accessories and Door Controls Group, Inc. is prohibited.

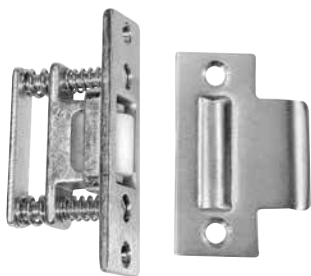

Roller Latch with No. 161 Strike No. 592

- Material:** Cast brass
- Finishes:** Available in standard architectural finishes (see page 9)
- Fastener:** Body: 2 ea. #8 x³/₄" FH combo screws
Strike: 2 ea. #8 x³/₄" FH combo screws
- Features:**
- Solid nylon roller for durable silent operation
 - Simple adjustment for roller projection
 - Accepted by the New York State Office of Mental Health (OMH) for use in high risk areas

No.	Latch Face	Strike	Weight
592	1" x 3 ³ / ₈ "	1 ¹ / ₈ " x 2 ³ / ₄ "	0.6 lbs.



Roller Latch with Angle Stop No. 593

- Material:** Cast brass.
- Finishes:** Available in standard architectural finishes (see page 9)
- Fastener:** Body: 2 ea. #12 x 1¹/₂" FH WS
Strike: 2 ea. #8 x³/₄" FH combo screws
- Features:**
- Mounts in header with strike in top of door
 - Solid nylon roller for durable silent operation
 - Simple adjustment for roller projection

No.	Latch Face	Strike	Projection	Weight	ANSI A156.16
593	1 ¹ / ₂ " x 4 ¹ / ₂ "	1 ¹ / ₈ " x 2 ¹ / ₄ "	⁵ / ₈ "	0.8 lbs.	E09111



Roller Latch with No. 161 Strike No. 594

- Material:** Cast brass
- Finishes:** Available in standard architectural finishes (see page 9)
- Fastener:** Body: 2 ea. #8 x³/₄" FH combo screws
Strike: 2 ea. #8 x³/₄" FH combo screws
- Features:**
- Solid nylon roller for durable silent operation
 - Simple adjustment for roller projection

No.	Latch Face	Strike	Weight
594	1 ¹ / ₈ " x 2 ¹ / ₄ "	1 ¹ / ₈ " x 2 ³ / ₄ "	0.7 lbs.



Secret Gate Latch No. 602

- Material:** Cast brass
- Finishes:** US4, US10, US10B, US10BE, US26D
- Features:**
- Single acting, reversible. Supplied with dummy knob
 - Bolt activated by pressing button concealed on bottom of latch case

No.	Fastener	Size	Weight
602	5 ea. #7 x 1 ¹ / ₄ " OH WS	Case: 2 ¹ / ₁₆ " x 2 ⁷ / ₁₆ " Strike: 2 ¹ / ₁₆ " x 3 ¹ / ₄ "	3.4 lbs./6

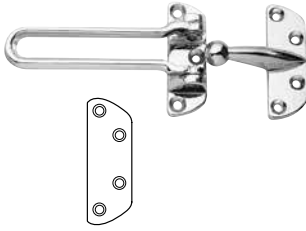

Door Guard No. 603

- Material:** Cast aluminum
- Finishes:** Antique brass (ANT), bright brass (BRS), bright chrome (CRM)
- Options:** 1/8" clear plastic shim - order separately as 603 SHIM

No.	Fastener	Size	Weight	ANSI A156.16
603	Body: 3 ea. #6 x 1 ¹ / ₂ " FH SMS Strike: 4 ea. #6 x 1" FH SMS	Body: 2 ⁹ / ₃₂ " x 2 ¹ / ₂ " Strike: 3 ¹ / ₃₂ " x 2 ¹ / ₂ "	3.3 lbs./10	L33042
603 SHIM		3 ¹ / ₃₂ " x 2 ¹ / ₂ "		

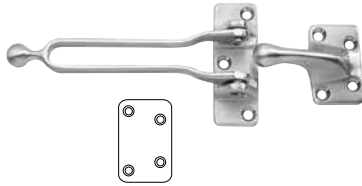

Door Guard No. 604

- Material:** Solid cast brass
- Finishes:** US3, US4, US10, US10B, US26, US26D
- Options:** 1/8" clear plastic shim – order separately as 604 SHIM

No.	Fastener	Size	Weight	ANSI A156.16
604	Body: 3 ea. #6 x 1 ¹ / ₂ " OH SMS Strike: 4 ea. #6 x 3 ³ / ₄ " OH SMS	Body: 1 ¹ / ₁₆ " x 2 ⁹ / ₁₆ " Strike: 1 ⁵ / ₈ " x 1 ¹ / ₁₆ "	4.4 lbs./10	L13042
604 SHIM		1 ¹ / ₁₆ " x 1 ¹ / ₁₆ "		



Door Guard Protection Plates No. 605, 605SMS

- Material:** Brass
- Finishes:** US3, US4, US5, US10, US10B, US26, US26D
- Features:** Protects corner of door from damage by door guard arm

No.	Fastener	Size	Weight
605	Self-adhesive tape	1 ¹ / ₈ " x 1" x 1/2" return	0.3 lbs./10
605SMS	#6 x 5/8" FH SMS	1 ¹ / ₈ " x 1" x 1/2" return	0.3 lbs./10

ASSA ABLOY
Opening Solutions

Experience a safer
and more open world

800-458-2424 | www.assaabloydooraccessories.us
Check the web site for the up-to-date catalog

Copyright © 2012-2020, ASSA ABLOY Accessories and Door Controls Group, Inc. All rights reserved. Reproduction in whole or in part without the express written permission of ASSA ABLOY Accessories and Door Controls Group, Inc. is prohibited.

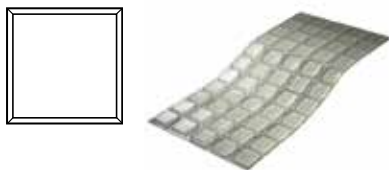

Wall Guard No. 606-RKW

- Material:** Clear rubber
- Other:** Sold in sheets of 55
- Features:** Self-adhesive mounting

No.	Fastener	Size	Weight
606-RKW	Self-adhesive back	1" x 1"	0.4 lbs./55

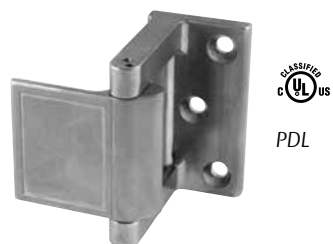

PDL



PDLAA

Privacy Door Latch No. PDL, PDLAA

- Material:** Zinc die cast
- Finishes:** PDLAA: US26D, US26, US15, BSP, US3, US4
PDL: BRS, DBRS, STNN, CRM, DCRM, ORB
- Features:**
- ADA compliant
 - Enhanced in room privacy
 - Easy to install
 - For use with UL Classified fire doors for use with hollow metal steel composite type fire doors rated up to and including 3 hrs
Wood composite type fire doors rated up to and including 1½ hrs and 20 minutes without hose stream

No.	Fastener	Size	Weight
PDL	#12 x 1¼" FH SMS	1½" x 2¾"	0.75 lbs.
PDLAA	#12 x 1-1/4" FH SMS	1½" x 2¾"	0.8 oz.

NOTE: The PDLAA is a design enhancement of the PDL. The PDL will be available for a limited time.

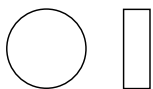

Door Silencer No. 608CA

- Material:** Clear rubber
- Other:** Sold in packages of 300
- Features:** Self-adhesive mounting

No.	Fastener	Size	Weight
608CA	¾" dia. x 1/8"	Metal or wood	0.2 lbs./300

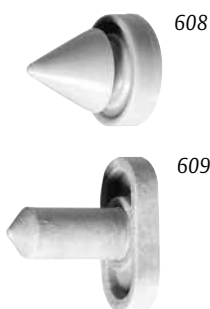

Door Silencers No. 608-RKW, 609

- Material:** Gray rubber
- Other:** Sold in packages of 100

No.	Size	Frame Type	Weight	ANSI A156.16
608-RKW	½" dia. x 5/8"	Metal	1.3 lbs./500	L03011
609	¾" x ¾"	Wood	1.3 lbs./500	L03021

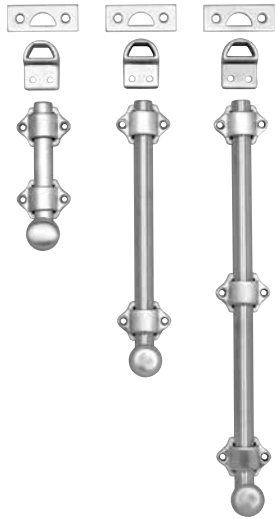

Surface Bolts No. 630 Series

Material: Solid brass

Finishes: US3, US10B, US26D, other finishes available on special order

- Features:**
- Unique fiber gasket provides slide resistance without marring surface of bolt
 - 1" diameter knob
 - Supplied with universal and mortise strike

No.	Fastener	Overall Size	Bolt Size	Bolt Length	Bolt Throw	Guides	Weight
630-4	8 ea. #6 x 3/4" OH SMS	1 5/8" x 4 3/8"	5/8" half round	4"	9/16"	2	2.5 lbs./5
630-8	8 ea. #6 x 3/4" OH SMS	1 5/8" x 8"	5/8" half round	8"	9/16"	2	3.9 lbs./5
630-12	10 ea. #6 x 3/4" OH SMS	1 5/8" x 12"	5/8" half round	12"	9/16"	3	5.3 lbs./5
630-24	12 ea. #6 x 3/4" OH SMS	1 5/8" x 24"	5/8" half round	24"	9/16"	4	11.8 lbs./5

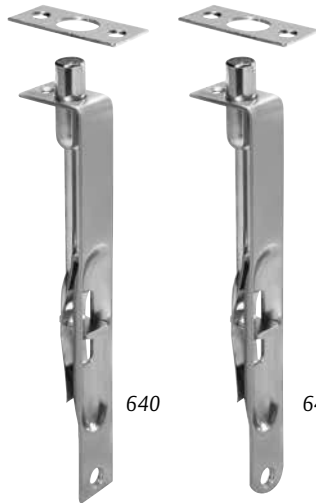

Residential Flush Bolts No. 640, 640RE

Material: Wrought brass

Finishes: US3, US5, US26D

Features: Spring action holds the bolt in either projected or retracted position

No.	Fastener	Overall Size	Bolt Size	Bolt Throw	Guides	Weight
640	4 ea. #6 x 3/4" FH SMS	3/4" x 6"	1/2" dia.	15/16"	7/8" x 2"	1.5 lbs./5
640RE	4 ea. #6 x 3/4" FH SMS	3/4" x 6"	1/2" dia.	15/16"	7/8" x 2"	1.5 lbs./5

ASSA ABLOY
Opening Solutions

Experience a safer
and more open world

800-458-2424 | www.assaabloydooraccessories.us
Check the web site for the up-to-date catalog

Copyright © 2012-2020, ASSA ABLOY Accessories and Door Controls Group, Inc. All rights reserved. Reproduction in whole or in part without the express written permission of ASSA ABLOY Accessories and Door Controls Group, Inc. is prohibited.

Door Coordinators No. 2600 Series

- Material:** Steel
- Finishes:** Black prime coat, silver powder coat
- Fastener:** 7 ea. #12 - 24x 1¹/₄ TH type C tapping screws
- Size:** Standard device size 5⁵/₈" x 1⁵/₈" x 52"
- Features:** Non-handed. Override protection to prevent damage in case of abnormal force on door Mechanism and filler bar completely fill width of opening and when painted to match frame it becomes virtually invisible
- Options:** Specify make and model of exit device for vertical rod preparation
- Ordering:** Stock Sizes



No.	Opening	Weight	ANSI A156.3
2660	60"	7.0 lbs.	Type 21A
2672	72"	8.0 lbs.	Type 21A
2696	96"	9.75 lbs.	Type 21A

Custom Sizes — The 2600 Series coordinators are manufactured in different housing lengths to coordinate the full range of door sizes:

- NX2600 Series: For jamb opening widths (A + B dimension) from 48" - 54". E dimension, 42"
- 2600 Series: For jamb opening widths (A + B dimension) from 54" - 96". E dimension, 52"

Determining Coordinator Item Number

- Active door widths A plus inactive door width B equals the last two or three digits of all 2600 Series coordinator item numbers (2680 is for 80" door opening)
- Less than 48" jamb widths = N2600 Series (N2644 = 44" opening).
- Larger sizes are available (XL, XXL). Contact the factory

NOTE: Some panic hardware requires the coordinator to be factory prepped. Contact factory.

No.	Jamb Widths	Coordinator Length	ANSI A156.3
NX2648- NX2654	48"-54"	42"	Type 21A
2655-2660	55"-60"	52"	Type 21A
2661-2672	61"-72"	52"	Type 21A
2673-2696	73"-96"	52"	Type 21A

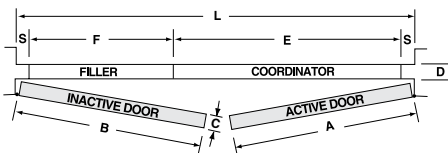

Fillers are usually supplied precut from the factory (filler bars shown on page E14).

NOTE: If "S" dimension is other than 5⁵/₈" advise the factory.

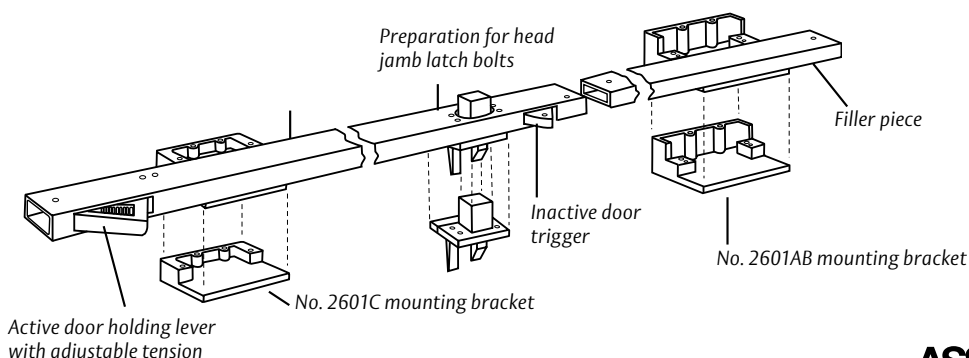

800-458-2424 | www.assaabloydooraccessories.us
 Check the web site for the up-to-date catalog

Copyright © 2012-2020, ASSA ABLOY Accessories and Door Controls Group, Inc. All rights reserved. Reproduction in whole or in part without the express written permission of ASSA ABLOY Accessories and Door Controls Group, Inc. is prohibited.

ASSA ABLOY
Opening Solutions

Experience a safer
and more open world



Carry Bar for No. 1600 /2600 Series Coordinator No. 1100

- Material:** Brass, steel
- Finishes:** US3, US4, US10, US10B, US26, US26D, and black prime coat
- Fastener:** 2 ea. 1/4-20x1 RH MS, 2 ea. 1/4-20x1 11/16 sex bolts
- Other:** A carry bar is used when it is possible to open the inactive door before opening the active door

No.	Size	Weight
1100	1 3/4" x 2 1/4"	0.3 lbs.



Filler Bar for No. 1600 /2600 Series Coordinator No. FB-1, FB-2

- Material:** Steel
- Finishes:** Black prime coat, silver powder coat
- Features:** Filler bar is supplied at no charge with the No. 1600 and 2600 Series coordinator (shown on pages E12 & E13)

No.	Size
FB-1	Specify length from 1 5/8" to 18 5/8"
FB-2	Specify length from 19 5/8" to 42 5/8"

Contact factory for larger sizes.



2601AB



2601C

Mounting Brackets (for Soffit Applied Hardware) No. 2601AB, 2601C

- Material:** Aluminum
- Finishes:** Black prime coat, silver powder coat
- Fastener:** 4 ea. 1/4-20x1/2" FH MS, 4 ea. #12-24x2" FH MS.
- Features:** Used for stop applied hardware. Prevents the inadvertent disabling of the coordinator by fasteners passing through the housing

No.	Soffit Size	Length	Weight
2601AB	7/8" - 2 1/4"	5"	0.9 lbs.
2601C	Over 2 1/4"	5"	0.8 lbs.



Universal Door Coordinator No. 1700

- Material:** Steel
- Finishes:** Black prime coat, US28
- Fastener:** 4 ea. 10-24 x 2" flat head machine screws and #10 x 2" sheet metal screws
- Features:** For pairs of doors. Non-handed. Stop mounted - no mounting brackets required for stop mounted hardware.



No.	Overall Size	Weight	ANSI A156.3
1700	1 5/8" x 20 3/16" x 3 3/4"	2.55 lbs.	Type 21B

NOTE: Not for use with surface vertical panic devices.

ASSA ABLOY
Opening Solutions

Experience a safer
and more open world

800-458-2424 | www.assaabloydooraccessories.us
Check the web site for the up-to-date catalog

Copyright © 2012-2020, ASSA ABLOY Accessories and Door Controls Group, Inc. All rights reserved. Reproduction in whole or in part without the express written permission of ASSA ABLOY Accessories and Door Controls Group, Inc. is prohibited.



Automatic Flush Bolts No. 2840 (Automatic Top Bolt Only) No. 2842 (Set) (replaces the No. 1840 and No. 1842)

Material: Brass, stainless steel

Finishes: US3, US4, US10, US10BE, US26, US26D, US32D

Fastener: No. 2842: 20 ea. #8 x 3/4" FH combo screws, 2 ea. #6-8 plastic anchors
No. 2840: 10 ea. #8 x 3/4" FH combo screws. NOTE: No plastic anchor required for top only

Features:

- For Fire Rated Metal Doors labeled A, B, C, D & E up to 4'w x 8'h
- Non-handed
- Fully automatic— opening active door retracts top and bottom bolts
- Override feature prevents damage to doors or bolts if bolt heads are blocked from entering strikes
- Bolt head rods are adjustable up to 1 1/2"
- Thermal lock automatically locks the inactive door under high heat conditions due to fire

Options: No. 2842 can be used with the No. 570 Dust Proof Strike (shown on page E4).

No.	Size	Weight	ANSI A156.3
2840	1" x 6 3/4"	1.2 lbs.	Type 25
2842	1" x 6 3/4"	2.4 lbs.	Type 25



Combination Flush Bolts No. 2805 (Self Latching Top Bolt Only) No. 2845 (Set) (replaces No. 1805 and No. 1845)

Material: Brass, stainless steel

Finishes: US3, US4, US10, US10BE, US26, US26D, US32D

Fastener: Top: 8 ea. #8 x 3/4" FH combo screws. NOTE: No plastic anchor required for top only.
Bottom (No. 2845 only) 18 ea. #8 x 3/4" FH combo screws, 2 ea. #6-8 plastic anchors.

Features:

- For Fire Rated Metal Doors labeled A, B, C, D & E up to 4'w x 8'h

Top Bolt

- Automatically engages when the inactive door closes. When the active door is opened, the inactive door stays latched at the top until the top bolt is released by pressing the plunger button on the bolt face

Bottom Bolt (No. 2845 only)

- Non-handed
- Fully automatic — opening active door retracts bottom bolt
- Override feature prevents damage to door or bolt if bolt head is blocked from entering strike
- Bolt head rod is adjustable up to 1 1/2"
- Thermal lock automatically locks the inactive door under high heat conditions due to fire

Options: No. 2845 can be used with the No. 570 Dust Proof Strike (shown on page E4)

No.	Size	Weight	ANSI A156.3
2805	1" x 6 3/4"	1.2 lbs.	Type 27
2845	1" x 6 3/4"	2.4 lbs.	Type 27



Automatic Flush Bolt No. 2940 (Automatic Top Bolt Only) No. 2942 (Set) (replaces No. 1940 and No. 1942)

Material: Brass, stainless steel

Finishes: US3, US4, US10, US10B, US10BE, US26, US26D, US32D

Fastener: No. 2940: 6 ea. #8 x 3/4" FH combo screws, 2 ea. #8 - 32 x 1/2" FH MS, 3 ea. #10 x 1" FH WS
NOTE: No plastic anchor required for top only.
 No. 2942: 12 ea. #8 x 3/4" FH combo screws, 4 ea. #8 - 32 x 1/2" FH MS, 6 ea. #10 x 1" FH WS, 2 ea. #6 - 8 plastic anchors

Features:

- For Wood Doors labeled B, C, D & E up to 4'w x 8"h
- Non-handed
- Fully automatic—opening active door retracts top and bottom bolts
- Override feature prevents damage to doors or bolts if bolt heads are blocked from entering strikes
- Bolt head rods are adjustable up to 1/2"
- Thermal lock automatically locks the inactive door under high heat conditions due to fire

Options: No. 2942 can be used with the No. 570 Dust Proof Strike (shown on page E4).

No.	Size	Weight	ANSI A156.3
2940	1" x 8 1/2"	1.5 lbs.	Type 25
2942	1" x 8 1/2"	2.9 lbs.	Type 25



Combination Flush Bolts No. 2905 (Self Latching Top Bolt Only) No. 2945 (Set) (replaces No. 1905 and No. 1945)

Material: Brass, stainless steel

Finishes: US3, US4, US10, US10B, US10BE, US26, US26D, US32D

Fastener: Top: 4 ea. #8 x 3/4" FH combo screws, 2 ea. #8 - 32 x 1/2" FH MS, 3 ea. #10 x 1" FH WS.
NOTE: No plastic anchor required for top only.
 Bottom (No. 2945 only): 10 ea. #8 x 3/4" FH combo screws, 4 ea. #8 - 32 x 1/2" FH MS, 6 ea. #10 x 1" FH WS, 2 ea. #6 - 8 plastic anchors

Features:

- For Wood Doors labeled B, C, D & E up to 4'w x 8'h

Top Bolt

- Automatically engages when the inactive door closes. When the active door is opened, the inactive door stays latched at the top until the top bolt is released by pressing the plunger button on the bolt face

Bottom Bolt (No. 2945 only)

- Non-handed
- Fully automatic — opening active door retracts bottom bolt
- Override feature prevents damage to door or bolt if bolt head is blocked from entering strike
- Bolt head rod is adjustable up to 1/2"
- Thermal lock automatically locks the inactive door under high heat conditions due to fire

Options: No. 2945 can be used with the No. 570 Dust Proof Strike (shown on page E4).

No.	Size	Weight	ANSI A156.3
2905	1" x 8 1/2"	1.5 lbs.	Type 27
2945	1" x 8 1/2"	2.9 lbs.	Type 27

ASSA ABLOY
Opening Solutions

Experience a safer
and more open world

800-458-2424 | www.assaabloydooraccessories.us

Check the web site for the up-to-date catalog

Copyright © 2012-2020, ASSA ABLOY Accessories and Door Controls Group, Inc. All rights reserved. Reproduction in whole or in part without the express written permission of ASSA ABLOY Accessories and Door Controls Group, Inc. is prohibited.



Automatic Flush Bolt with Bottom Fire Bolt No. 2848 (replaces 1848)

Material: Brass, stainless steel

Finishes: US3, US4, US10, US10B, US10BE, US26, US26D, US32D

Fastener: 10 ea. #8x³/₄" FH combo screws, 4 ea. plastic anchors

Features:

- For Fire Rated Metal Doors
- Low (5 lbs. maximum) closing force
- Fully automatic—opening active door retracts top bolt
- Override feature prevents damage to doors or bolt if bolt head is blocked from entering strike
- Bolt head rod is adjustable up to 1¹/₂"
- For fire rated metal doors labeled A, B, C, D, & E up to 4' w x 9' h
- Thermal lock automatically locks the inactive door under high heat conditions due to fire
- Bottom fire bolt eliminates need for floor prep
- Oversize fire bolt strike hole allows for slight door misalignment

No.	Size	Weight
2848	Top bolt: 1" x 6 ³ / ₄ " Bottom bolt: 1 ³ / ₁₆ " dia.	1.3 lbs.



Automatic Flush Bolt with Bottom Fire Bolt No. 2948 (replaces 1948)

Material: Brass, stainless steel

Finishes: US3, US4, US10, US10B, US10BE, US26, US26D, US32D

Fastener: 8 ea. #8x³/₄" FH combo screws, 2 ea. plastic anchors;
3 ea. #10x1" FH WS

Features:

- For Fire Rated Wood Doors
- Low (5 lbs. maximum) closing force
- Fully automatic—opening active door retracts top bolt
- Override feature prevents damage to doors or bolt if bolt head is blocked from entering strike
- Bolt head rod is adjustable up to 1¹/₂"
- For fire rated UL listed 20-minute wood core and composite doors up to 4' w x 9' h
- Thermal lock automatically locks the inactive door under high heat conditions due to fire
- Bottom fire bolt eliminates need for floor prep
- Oversize fire bolt strike hole allows for slight door misalignment

No.	Size	Weight
2948	Top bolt: 1" x 8 ¹ / ₂ " Bottom bolt: 1 ³ / ₁₆ " dia.	1.6 lbs.



Bottom Fire Bolt (for Metal Doors) No. 18BFB

Material: Stainless steel

Finishes: US32D

Features:

- Eliminates the bottom automatic flush bolt and dust proof strike
- When door is subjected to 230°F the plug and gray plastic cover will melt allowing the bolt to project, locking the leaves together
- UL Listed only when used with automatic top bolt

No.	Size	Weight
18BFB	Bolt: $1\frac{3}{16}$ " x $1\frac{9}{16}$ " Plug: $1\frac{7}{32}$ " dia.	0.1 lbs.



Cover Plate Kit (for Metal Doors) No. CPK2840

Material: Brass.

Finishes: US3, US4, US10, US10B, US26, US26D

Fastener: 4 ea. #8 x $\frac{3}{4}$ " FH combo screws

Features: Covers existing bottom 1840 flush bolt prep

No.	Size	Weight
CPK2840	1" x $6\frac{3}{4}$ "	0.1 lbs.



Bottom Fire Bolt (for Wood Doors) No. 19BFB

Material: Stainless steel

Finishes: US32D

Features:

- Eliminates the bottom automatic flush bolt and dust proof strike
- When door is subjected to 230°F the plug and black plastic cover will melt allowing the bolt to project, locking the leaves together
- UL Listed only when used with automatic top bolt

No.	Size	Weight
19BFB	Bolt: $1\frac{3}{16}$ " x $1\frac{9}{16}$ " Plug: $1\frac{13}{64}$ " dia.	0.1 lbs.

ASSA ABLOY
Opening Solutions

Experience a safer
and more open world

800-458-2424 | www.assaabloydooraccessories.us

Check the web site for the up-to-date catalog

Copyright © 2012-2020, ASSA ABLOY Accessories and Door Controls Group, Inc. All rights reserved. Reproduction in whole or in part without the express written permission of ASSA ABLOY Accessories and Door Controls Group, Inc. is prohibited.



Automatic Flush Bolt with Bottom Fire Bolt No. 2960 (replaces 1960)

Material: Brass

Finishes: US3, US4, US10, US10B, US10BE, US26, US26D, US32D

Fastener: 4 ea. #8 x 1" FH SMS, 4 ea. #8 x 3/4" FH combo screws, 2 ea. plastic anchors

- Features:**
- For Fire Rated Wood Core & Composite Doors
 - Durable, tested over 1 million cycles
 - Smaller profile adds stability to the door
 - Only two 1 1/8" diameter holes for easier door preparation
 - Preparation prevents the veneer from splitting at the corners of the door
 - Quiet & smooth activation
 - Fully automatic—opening active door retracts top bolt
 - Non-handed.
 - Override feature prevents damage to doors or bolt if bolt head is blocked from entering strike
 - Low (3 lbs. maximum) closing force. ADA Compliant
 - Adjustable bolt head rod: bolts can be vertically adjusted 1/2" for unusual clearances
 - For up to 4' w x 9' h fire rated wood core & composite doors up to 20 minutes fire rating.

No.	Face Plate Size	Weight
2960	1 1/8" x 2 1/4"	0.9 lbs.

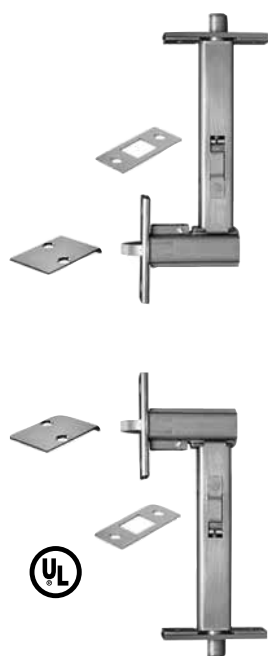

Automatic Flush Bolts No. 2962 (replaces 1962)

Material: Brass, stainless steel

Finishes: US3, US4, US10, US10B, US10BE, US26, US26D, US32D

Fastener: 8 ea. #8 x 1" FH SMS, 8 ea. #8 x 3/4" FH combo screws, 4 ea. plastic anchors

- Features:**
- For Fire Rated Wood Core & Composite Doors
 - Durable, tested over 1 million cycles
 - Smaller profile adds stability to the door
 - Only two 1 1/8" diameter holes for easier door preparation
 - Preparation prevents the veneer from splitting at the corners of the door
 - Quiet & smooth activation
 - Fully automatic—opening active door retracts top & bottom bolts.
 - Non-handed
 - Override feature prevents damage to doors or bolt if bolt head is blocked from entering strike
 - Low (3 lbs. maximum) closing force. ADA Compliant
 - Adjustable bolt head rods: bolts can be vertically adjusted 1/2" for unusual clearances
 - For up to 4' w x 9' h fire rated wood core & composite doors up to 1 1/2 hours fire rating

No.	Face Plate Size	Weight
2962	1 1/8" x 2 1/4"	1.7 lbs.



Self Latching Flush Bolt with Bottom Fire Bolt No. 2849 (replaces 1849)

- Material:** Brass, stainless steel
- Finishes:** US3, US4, US10, US10B, US10BE, US26, US26D, US32D.
- Fastener:** 8 ea. #8 x 3/4" FH combo screws, 4 ea. plastic anchors
- Features:**
- For Fire Rated Metal Doors
 - Non-handed.
 - Low (5 lbs. maximum) closing force
 - Self latching top bolt
 - Override feature prevents damage to doors or bolt if bolt head is blocked from entering strike
 - Bolt head rod is adjustable up to 1 1/2"
 - For fire rated metal doors labeled A, B, C, D, & E up to 4' w x 9' h
 - Thermal lock automatically locks the inactive door under high heat conditions due to fire
 - Bottom fire bolt eliminates need for floor prep
 - Oversize fire bolt strike hole allows for slight door misalignment

No.	Size	Weight
2849	Top bolt: 1" x 6 3/4" Bottom bolt: 1 3/16" dia.	1.3 lbs.



Self Latching Flush Bolt with Bottom Fire Bolt No. 2949 (replaces 1949)

- Material:** Brass, stainless steel
- Finishes:** US3, US4, US10, US10B, US10BE, US26, US26D, US32D
- Fastener:** 6 ea. #8 x 3/4" FH combo screws, 2 ea. plastic anchors, 3 ea. #10 x 1" FH WS
- Features:**
- For Fire Rated Wood Doors
 - Non-handed
 - Low (5 lbs. maximum) closing force
 - Self latching top bolt
 - Override feature prevents damage to doors or bolt if bolt head is blocked from entering strike
 - Bolt head rod is adjustable up to 1/2"
 - For fire rated UL listed 20-minute wood core and composite doors up to 4' w x 8' h
 - Thermal lock automatically locks the inactive door under high heat conditions due to fire
 - Bottom fire bolt eliminates need for floor prep
 - Oversize fire bolt strike hole allows for slight door misalignment

No.	Size	Weight
2949	Top bolt: 1" x 8 1/2" Bottom bolt: 1 3/16" dia.	1.6 lbs.

ASSA ABLOY
Opening Solutions

Experience a safer
and more open world

800-458-2424 | www.assaabloydooraccessories.us
Check the web site for the up-to-date catalog

Copyright © 2012-2020, ASSA ABLOY Accessories and Door Controls Group, Inc. All rights reserved. Reproduction in whole or in part without the express written permission of ASSA ABLOY Accessories and Door Controls Group, Inc. is prohibited.

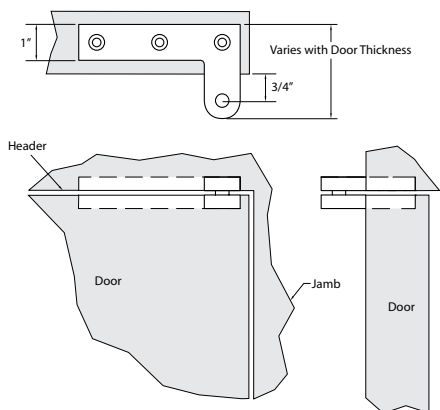

Standard Head Pivot No. CP10, CP10HD

- Material:** Solid brass
- Finishes:** US3, US4, US10, US10B, US26, US26D, other finishes available on request
- Fastener:** 6 ea. #12 x 1¹/₄" FH wood screws
- Ordering:** Specify door thickness
- Features:**
- Mostly invisible when installed
 - Includes Teflon® bearing for smooth silent operation
 - Field changeable handing
 - Standard duty is made from ³/₈" thick brass
 - Heavy duty (HD) is made from ¹/₂" thick brass

No.	Weight
CP10	1.3 lbs.
CP10HD	1.9 lbs.

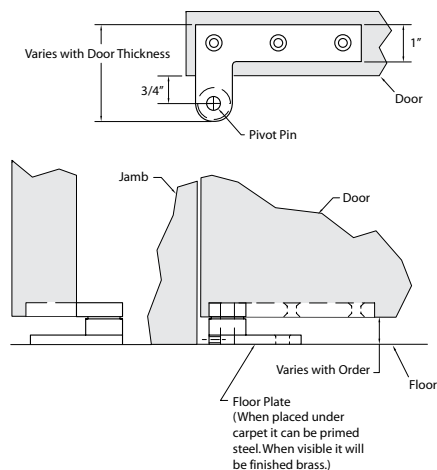

Standard Floor Pivot No. CP40, CP40HD

- Material:** Solid brass
- Finishes:** US3, US4, US10, US10B, US26, US26D, other finishes available on request
- Fastener:** 6 ea. #12 x 1¹/₄" FH wood screws
- Ordering:** Specify door thickness and floor clearing
- Features:**
- Mostly invisible when installed
 - Includes Teflon® bearing for smooth silent operation
 - Field changeable handing
 - Standard duty is made from ³/₈" thick brass
 - Heavy duty (HD) is made from ¹/₂" thick brass

No.	Weight
CP40	1.3 lbs.
CP40HD	1.9 lbs.



Door Knocker No. 611

- Material:** Solid cast brass
- Finishes:** Available in standard architectural finishes (see page 9)
- Fastener:** 2 ea. #8-32x2" FH MS (for standard 1³/₄" doors); 2 ea. #8 finish washers
- Options:**
- Drill for door viewer No. 621 (order viewer separately)
 - Engrave numbers or name. Assorted fonts are available

No.	Size	Weight	ANSI A156.16
611	3 ⁵ / ₈ " x 6 ³ / ₄ "	0.6 lbs.	L03151



No. 614

No. 614V

Door Knockers No. 614, 614V

- Material:** Cast brass
- Finishes:** Available in standard architectural finishes (see page 9)
- Fastener:** 2 ea. #8-32x2" FH MS (for standard 1³/₄" doors); 2 ea. #8 finish washers
- Features:** No. 614V includes door viewer No. 622
- Options:** Engrave numbers or name

No.	Size	Weight	ANSI A156.16
614	2 ¹ / ₈ " x 3"	0.4 lbs.	L03161
614V	2 ¹ / ₈ " x 3"	0.4 lbs.	L03161



No. 619

No. 620/621



No. 624

160° Door Viewers No. 619, 620, 620VC, 621, 624

- Material:** Brass
- Finishes:** Antique bronze (ANT), brass (BRS), bright chrome (CRM), satin nickel (*STNN)
*only available on 619, 620
- Other:** Installation - drill 1/2" hole
- Features:** No. 624 features a privacy cover to prevent visual intrusion from outside of the room

No.	Inside Cover	For Doors	Weight	ANSI A156.16
619	No	1 ¹ / ₁₆ " to 1 ¹ / ₁₆ "	0.05 lbs.	L03222, L03172
620	No	1 ³ / ₈ " to 2"	0.1 lbs.	L03222, L03172
620VC	Cover only		0.1 lbs./10	
621	No	2" to 2 ¹ / ₂ "	0.1 lbs.	L03222, L03172
624	Yes	1 ³ / ₈ " to 2"	0.1 lbs.	L03222, L03172

Recommended Location for Viewers

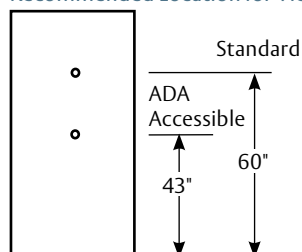

800-458-2424 | www.assaabloydooraccessories.us
Check the web site for the up-to-date catalog

Copyright © 2012-2020, ASSA ABLOY Accessories and Door Controls Group, Inc. All rights reserved. Reproduction in whole or in part without the express written permission of ASSA ABLOY Accessories and Door Controls Group, Inc. is prohibited.

ASSA ABLOY
Opening Solutions

Experience a safer
and more open world



No. 626



No. 622

190° Door Viewer No. 622, 622VC, 626

Material: Brass

Finishes: Antique bronze (ANT), brass (BRS), bright chrome (CRM), dull chrome (DCRM), satin nickel (STNN)

Other: Installation – drill $\frac{9}{16}$ " hole

Features: No. 626 features a privacy cover to prevent visual intrusion from outside of the room

No.	Inside Cover	For Doors	Weight	ANSI A156.16
622	No	$1\frac{3}{8}$ " to $2\frac{1}{8}$ "	0.1 lbs.	L03221, L03171
622VC	Cover only		0.1 lbs./10	
626	Yes	$1\frac{3}{8}$ " to $2\frac{1}{8}$ "	0.1 lbs.	L03221, L03171



No. 627, 628, 629

190° Door Viewer with Heavy Duty Privacy Cover No. 627, 628, 629

Material: Brass

Finishes: Bright chrome (CRM), Black (BLK)

Other: Installation – drill $\frac{9}{16}$ " hole. UL fire rated for 1½ hours

Features: Heavy duty privacy cover to prevent visual intrusion from outside of the room

No.	For Doors	Weight	ANSI A156.16
627	$1\frac{3}{8}$ " to $2\frac{1}{8}$ "	0.1 lbs.	L03221, L03171
628	$\frac{9}{16}$ " to $\frac{13}{16}$ "	0.1 lbs.	L03221, L03171
629	$\frac{15}{16}$ " to $1\frac{1}{4}$ "	0.1 lbs.	L03221, L03171

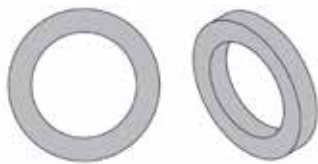

Door Viewer Washer No. 618W

Material: Brass

Finishes: Polished brass (BRS), bright chrome (CRM), satin nickel (STNN), antique bronze (ANT)

Other: Designed for use when the door is not thick enough to meet the specifications of the viewer. Can be used with all Rockwood Door Viewers.

No.	For Doors	Dimensions
618W	$\frac{9}{16}$ " to $2\frac{1}{2}$ "	$\frac{1}{8}$ " width, $\frac{9}{16}$ " inner dia, $\frac{13}{16}$ " outer dia



Card Holder No. 651

Material: Cast brass

Finishes: Available in standard architectural finishes (see page 9)

Fastener: 2 ea. #8 x $\frac{3}{4}$ " OH SMS

No.	Size	Card Size	Opening	Weight
651	$2\frac{1}{2}$ " x $4\frac{1}{4}$ "	2" x $3\frac{1}{2}$ "	$1\frac{3}{4}$ " x $3\frac{1}{4}$ "	0.2 lbs.

ASSA ABLOY
Opening Solutions

Experience a safer
and more open world

800-458-2424 | www.assaabloydooraccessories.us

Check the web site for the up-to-date catalog

Copyright © 2012-2020, ASSA ABLOY Accessories and Door Controls Group, Inc. All rights reserved. Reproduction in whole or in part without the express written permission of ASSA ABLOY Accessories and Door Controls Group, Inc. is prohibited.

- THIS DOOR TO REMAIN UNLOCKED DURING BUSINESS HOURS** No. 660
- THIS DOOR TO REMAIN UNLOCKED WHILE BUILDING IS OCCUPIED** No. 661
- THESE DOORS TO REMAIN UNLOCKED WHILE BUILDING IS OCCUPIED** No. 662-RKW

Decal No. 660, 661, 662-RKW

- Material:** Silver foil
- Fastener:** Self-adhesive mounting
- Other:** Black lettering
- Size:** 1½" x 26½"



Engraved Signs No. 670 Series

- Material:** .125" plastic or .050" aluminum, brass, bronze, stainless steel
- Finishes:** Plastic signs: available in black or brown with white lettering
Metal signs: available in standard architectural finishes (see page 9)
- Fastener:** 2 ea. #6 x 5/8" OH SMS
- Ordering:** Specify product number, finish, and copy
- Features:**
 - Standard letter size is 1" high by 1/8" wide stroke. Other sizes from 1/2" to 3" are available
 - Standard font is US Block, other fonts available
 - Sign size is determined by the height and length of the engraving and is calculated to allow for an appropriate border
- Options:**
 - SA – self-adhesive mounting
 - Custom sizes and messages

No.	Message	Size	ANSI 156.16
670	Specify copy	2" x width required	L03201
670M	MEN	2" x 5"	L03201
670W	WOMEN	2" x 7"	L03201
670R	RESTROOM	2" x 10"	L03201



No. 674L No. 674H

Engraved Signs No. 674H, 674L

- Material:** .125" plastic or .050" aluminum, brass
- Finishes:** Plastic signs: available in black or brown with white lettering
Metal signs: available in standard architectural finishes (see page 9)
- Fastener:** Self-adhesive mounting
- Size:** 1" x 4½"

800-458-2424 | www.assaabloydooraccessories.us
Check the web site for the up-to-date catalog

Copyright © 2012-2020, ASSA ABLOY Accessories and Door Controls Group, Inc. All rights reserved. Reproduction in whole or in part without the express written permission of ASSA ABLOY Accessories and Door Controls Group, Inc. is prohibited.

ASSA ABLOY
Opening Solutions

Experience a safer
and more open world

. MEN .

. WOMEN .

. RESTROOM .

. ADMINISTRATION .

Barrier Free Engraved Signs (with Braille Translation) No. BF680 Series

Material: .125" non-glare plastic or .050" brass, bronze

Finishes: Plastic signs: available in black, blue, brown, or red with white lettering
Metal signs: available in standard architectural finishes (see page 9).

Fastener: 2 ea. #6 x ⁵/₈" OH SMS

Ordering: Specify product number, finish, and copy

Features:

- Plastic signs meet ANSI A117.1-1998 section 703 requirements.
- 1" letter height is standard; other sizes available from ⁵/₈" to 2"
- Meets width to height ratio requirements
- Sign size is determined by the height and length of the engraving and is calculated to allow for an appropriate border
- Grade 2 braille translation on sign
- Screws provided for secure mounting
- Made to order, any copy available
- Plastic signs have easy to read letters and numbers that are raised ¹/₃₂" from sign surface
- Plastic signs characters and background have a non-glare finish of contrasting light on dark color
- Metal signs have easy to read raised black lettering

Options:

- SA – self-adhesive mounting
- Custom sizes and messages

No.	Message	Size	ANSI 156.16
BF680	Specify copy	2 ¹ / ₂ " x width required	L03201
BF680M	MEN	2 ¹ / ₂ " x 5"	L03201
BF680W	WOMEN	2 ¹ / ₂ " x 7"	L03201
BF680R	RESTROOM	2 ¹ / ₂ " x 9"	L03201

ASSA ABLOY
Opening Solutions

Experience a safer
and more open world

800-458-2424 | www.assaabloydooraccessories.us
Check the web site for the up-to-date catalog

Copyright © 2012-2020, ASSA ABLOY Accessories and Door Controls Group, Inc. All rights reserved. Reproduction in whole or in part without the express written permission of ASSA ABLOY Accessories and Door Controls Group, Inc. is prohibited.

BF Series ADA Signs

- Material:** .125" non-glare plastic or .050" brass, bronze
- Finishes:** Plastic signs: available in black, blue, brown, or red with standard 1" white lettering
Metal signs: available in standard architectural finishes (see page 9)
- Fastener:** 4 ea. #6 x 5/8" OH SMS
- Size:** 8" x 8"
- Ordering:** Specify background finish along with any options
- Features:** **Plastic signs:**
- Raised characters and Grade 2 Braille translation
 - Meets ADAAG Section 4.30 requirements
- Metal signs:**
- Raised black lettering and Grade 2 Braille translation.
 - Attractive architectural finishes
- Options:**
- SA – self-adhesive mounting

No. BF683



No. BF684



No. BF685



No. BF686



No. BF687



No. BF688



No. BF689



Recommended Mounting Location for Signs

Excerpts from ADA Accessibility Guidelines for Buildings and Facilities (ADAAG).

4.30.6 Mounting Location and Height: Where permanent identification is provided for rooms and spaces, signs shall be installed on the wall adjacent to the latch side of the door. Where there is no wall space to the latch side of the door, including at double leaf doors, signs shall be placed on the nearest adjacent wall. Mounting height shall be 60" (1525 mm) above the finish floor to the centerline of the sign. Mounting location for such signage shall be so that a person may approach within 3" (76 mm) of signage without encountering protruding objects or standing within the swing of a door.

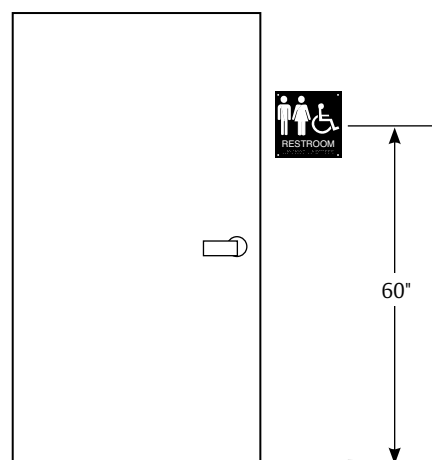

BFM Series ADA Molded Plastic Signs

- Material:** Molded plastic
- Colors:** 5/8" white lettering on choice of blue or black background
- Fastener:** Self-adhesive mounting
- Size:** 6" x 9"
- Ordering:** Specify product number and background color
- Features:**
 - Raised lettering and Grade 2 Braille translation
 - Meets ADAAG Section 4.30 requirements
 - Economical molded plastic

No. BFM682



No. BFM684



No. BFM685



No. BFM686



No. BFM687



No. BFM688



No. BFM689



All Gender Restroom Signs

Economical molded plastic; 6" x 9" and 12" diameter. White lettering on Blue background. Self-adhesive mounting. BFM625 has raised lettering and Grade 2 Braille translation.



BFM624



BFM625

Recommended Mounting Location for Signs

Excerpts from ADA Accessibility Guidelines for Buildings and Facilities (ADAAG).

4.30.6 Mounting Location and Height: Where permanent identification is provided for rooms and spaces, signs shall be installed on the wall adjacent to the latch side of the door. Where there is no wall space to the latch side of the door, including at double leaf doors, signs shall be placed on the nearest adjacent wall. Mounting height shall be 60" (1525 mm) above the finish floor to the centerline of the sign. Mounting location for such signage shall be so that a person may approach within 3" (76 mm) of signage without encountering protruding objects or standing within the swing of a door.

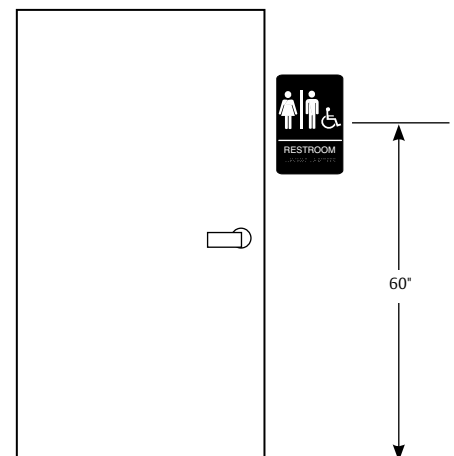



Hand Rail Brackets No. 700, 701, 702

Material: Cast brass

Finishes: Available in standard architectural finishes (see page 9)

	Fastener:	
	Wood rail	Metal rail
700	$\frac{5}{16}$ " - 18x1 $\frac{1}{2}$ " FH MS, anchor; 3 ea. #12 - 24x1" FH MS; 2 ea. #8x $\frac{3}{4}$ " OH SMS; 1 ea. back plate	$\frac{5}{16}$ " - 18x1 $\frac{1}{2}$ " FH MS, anchor; 3 ea. #12 - 24x1" FH MS; 2 ea. #8 - 32x $\frac{3}{4}$ " OH MS; 1 ea. back plate.
701	$\frac{5}{16}$ " - 18x3" FH MS, toggle; 3 ea. #12 - 24x1" FH MS; 2 ea. #8x $\frac{3}{4}$ " OH SMS; 1 ea. back plate.	$\frac{5}{16}$ " - 18x3" FH MS, toggle; 3 ea. #12 - 24x1" FH MS; 2 ea. #8 - 32x $\frac{3}{4}$ " OH MS; 1 ea. back plate.
702	3 ea. #12x2 FH WS; 2 ea. #8x $\frac{3}{4}$ " OH SMS.	3 ea. #12x2" FH WS; 2 ea. #8 - 32x $\frac{3}{4}$ " OH MS.

Ordering: Specify wood rail or metal rail

No.	Base	Projection (to rail centerline)	Weight
700	2 $\frac{13}{16}$ "	3 $\frac{1}{2}$ "	2.0 lbs.
701	2 $\frac{13}{16}$ "	3 $\frac{1}{2}$ "	1.8 lbs.
702	2 $\frac{13}{16}$ "	3 $\frac{1}{2}$ "	1.5 lbs.



Small Coat Hook No. 790

- Material:** Cast brass
Finishes: Available in standard architectural finishes (see page 9)
Fastener: 2 ea. #6 x ⁵/₈" OH SMS

No.	Size	Projection	Weight	ANSI A156.16
790	1 ¹ / ₄ " w x 1 ³ / ₈ " h	1 ⁷ / ₈ "	.9 lbs./10	L03111



Small Double Coat Hook No. 796

- Material:** Cast brass
Finishes: Available in standard architectural finishes (see page 9)
Fastener: 2 ea. #6 x ³/₄" OH SMS

No.	Size	Projection	Weight
796	1 ¹ / ₈ " w x 1 ¹ / ₈ " h	1 ¹ / ₈ "	1 lbs./10



Medium Coat Hook No. 802

- Material:** Cast brass
Finishes: Available in standard architectural finishes (see page 9)
Fastener: 2 ea. #6 x ³/₄" RH WS

No.	Size	Projection	Weight	ANSI A156.16
802	1 ³ / ₁₆ " w x 1 ¹ / ₂ " h	3"	1.1 lbs./10	L03111



Medium Coat Hook No. 806

- Material:** Cast brass
Finishes: Available in standard architectural finishes (see page 9)
Fastener: 2 ea. #6 x ³/₄" OH WS

No.	Size	Projection	Weight	ANSI A156.16
806	1 ¹ / ₁₆ " w x 1 ¹ / ₄ " h	3 ¹ / ₈ "	1.4 lbs./10	L03111

ASSA ABLOY
Opening Solutions

Experience a safer
and more open world

800-458-2424 | www.assaabloydooraccessories.us
Check the web site for the up-to-date catalog

Copyright © 2012-2020, ASSA ABLOY Accessories and Door Controls Group, Inc. All rights reserved. Reproduction in whole or in part without the express written permission of ASSA ABLOY Accessories and Door Controls Group, Inc. is prohibited.



1¹/₈" Ball Knob No. 841

- Material:** Solid brass.
Finishes: US3, US26, other finishes available upon request.
Fastener: #8 - 32 x 1" TH MS.
Options: Other screw lengths available upon request.

No.	Base	Projection	Weight	ANSI A156.9
841	³ / ₄ " dia.	1 ¹ / ₈ "	2.5 lbs./10	B02131



Utility Pull No. 845

- Material:** Aluminum, brass.
Finishes: US3, US4, US10, US10B, US26, US26D, burnished aluminum (ALM).
Fastener: 4 ea. #8 x ³/₄" OH SMS.

No.	Size	Projection	Weight
845	1 ⁷ / ₈ " x 5 ⁷ / ₈ "	1 ¹ / ₂ "	1.6 lbs./10 (aluminum) 2.5 lbs./10 (brass)



Solid Wire Pull No. 850, 851, 852, 853

- Material:** Brass, stainless steel.
Finishes: US3, US4, US10, US10B, US26, US26D, US32D, US32DMS.
Fastener: #8 - 32 x 1" TH MS.
Options: Other CTC's available upon request.

No.	Size	CTC	Projection	Weight	ANSI A156.9
850	⁵ / ₁₆ " dia.	2 ³ / ₄ "	1 ¹ / ₄ "	3.4 lbs./25	B02011
851	⁵ / ₁₆ " dia.	3"	1 ¹ / ₄ "	3.8 lbs./25	B02011
852	⁵ / ₁₆ " dia.	3 ¹ / ₂ "	1 ¹ / ₄ "	3.9 lbs./25	B02011
853	⁵ / ₁₆ " dia.	4"	1 ¹ / ₄ "	4.0 lbs./25	B02011



Heavy Wire Pull No. 856-RKW

- Material:** Brass, bronze, stainless steel.
Finishes: US3, US4, US10, US10B, US26, US26D, US32D, US32DMS.
Fastener: #8 - 32 x 1" TH MS.
Options: Other CTC's available upon request.

No.	Size	CTC	Projection	Weight	ANSI A156.9
856-RKW	¹ / ₂ " dia.	4"	1 ³ / ₄ "	4.5 lbs./10	B02011



Flush Cup Pull No. 860

- Material:** Brass, stainless steel
Finishes: US3, US10B, US10BE, US32D
Fastener: 2 ea. #4 x 5/8" OH WS
Other: See website for installation template

No.	Size	Weight	ANSI A156.14
860	2 1/2" dia.	0.9 lbs./10	B02201



Wrought Flush Pull No. 870

- Material:** Brass, stainless steel
Finishes: US3, US10B, US10BE, US32D
Fastener: 2 ea. #4 x 5/8" OH WS

No.	Size	Weight	ANSI A156.14
870	1 3/8" x 3 3/16"	0.5 lbs./10	D0781

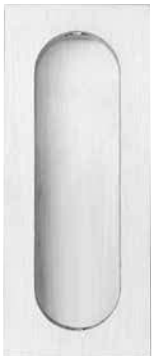

Cast Flush Pull No. 872

- Material:** Cast brass
Finishes: US3, US10B, US10BE, US32D
Fastener: 2 ea. #4 x 5/8" OH WS

No.	Size	Weight	ANSI A156.14
872	1 5/16" x 3 1/8"	0.2 lbs.	D0781

ASSA ABLOY
Opening Solutions

Experience a safer
and more open world

800-458-2424 | www.assaabloydooraccessories.us
Check the web site for the up-to-date catalog

Copyright © 2012-2020, ASSA ABLOY Accessories and Door Controls Group, Inc. All rights reserved. Reproduction in whole or in part without the express written permission of ASSA ABLOY Accessories and Door Controls Group, Inc. is prohibited.



Cast Lever Edge Pull No. 880

Material: Cast brass
Finishes: US3, US10B, US26D
Fastener: 2 ea. #6x $\frac{3}{4}$ " FH SMS

No.	Size	Weight	ANSI A156.14
880	$\frac{3}{4}$ "x $3\frac{7}{8}$ "	0.2 lbs.	D2801



Concealed Edge Pull No. 885-RKW

Material: Brass
Finishes: Available in standard architectural finishes (see page 9)
Fastener: 2 ea. #6x1" FH WS

No.	Size	Weight
885-RKW	1"x $4\frac{1}{4}$ "	0.5 lbs.



Pocket Door Pull No. 890

Material: Brass
Finishes: US3, US10B, US26, US26D
Fastener: 2 ea. #6x $\frac{5}{8}$ " OH SMS
Other: For use on $1\frac{3}{8}$ " and $1\frac{3}{4}$ " doors

No.	Size	Weight	ANSI A156.14
890	$2\frac{1}{2}$ " w x $2\frac{3}{4}$ " h	0.4 lbs.	D0821



Pocket Door Privacy Latch No. 891

Material: Brass
Finishes: US3, US10B, US26, US26D
Fastener: 4 ea. #6x $\frac{5}{8}$ " OH SMS
Other: For use on $1\frac{3}{8}$ " and $1\frac{3}{4}$ " doors
Features:

- Turn piece locks to jamb strike
- Emergency release on opposite side

No.	Size	Weight	ANSI A156.14
891	$2\frac{1}{2}$ " w x $2\frac{3}{4}$ " h	0.4 lbs.	D0831



Heavy Duty Magnetic Catch No. 900

- Material:** Aluminum
- Finishes:** Brass (BRS), natural aluminum (ALM)
- Fastener:** Body: 2 ea. #6 x 1/4" TH SMS
Strike: 2 ea. #6 x 1/2" FH SMS
- Features:**
- Includes installation instructions
 - Dual double-pole, self-aligning magnets
 - Packed with two short strikes and one long strike
 - Can be used on pair of doors or single door

No.	Body Size	Strike Size	Weight	ANSI A156.9
900	9/16" x 3 1/8" x 1"	1 ea. 5/8" x 3 1/8" 2 ea. 5/8" x 1 1/8"	0.25 lbs.	B03161



Extra Heavy Duty Magnetic Catch No. 901

- Material:** Aluminum
- Finishes:** Brass (BRS), natural aluminum (ALM)
- Fastener:** Body: 2 ea. #6 x 1/2" TH SMS
Strike: 2 ea. #6 x 1/2" FH SMS
- Features:**
- Includes installation instructions
 - Dual triple-pole, self-aligning magnets
 - Packed with two short strikes and one long strike
 - Can be used on pair of doors or single door

No.	Body Size	Strike Size	Weight	ANSI A156.9
901	13/16" x 3 1/8" x 1"	1 ea. 7/8" x 3 1/8" 2 ea. 7/8" x 1 1/8"	0.35 lbs.	B03161

ASSA ABLOY
Opening Solutions

Experience a safer
and more open world

800-458-2424 | www.assaabloydooraccessories.us
Check the web site for the up-to-date catalog

Copyright © 2012-2020, ASSA ABLOY Accessories and Door Controls Group, Inc. All rights reserved. Reproduction in whole or in part without the express written permission of ASSA ABLOY Accessories and Door Controls Group, Inc. is prohibited.



No. 910

Adjustable Ball Catch - Square Corners No. 910, 911

- Material:** Brass
- Finishes:** US3, US26D
- Fastener:** 4 ea. #6 x 3/4" FH SMS
- Other:** No. 910: Narrow strike for mounting on door, catch in jamb
No. 911: Wide strike for mounting on jamb, catch in door
- Features:** Dual adjustment for door clearance and holding strength

No.	Body Size	Strike Size	Weight	ANSI A156.9
910	1" x 2 1/8"	1 1/16" x 2 1/8"	0.2 lbs.	B03017
911	1" x 2 1/8"	1 3/8" x 2 1/8"	0.2 lbs.	B03017



No. 911RC

Adjustable Ball Catch - Round Corners No. 910RC, 911RC

- Material:** Brass
- Finishes:** US3, US26D
- Fastener:** 4 ea. #6 x 3/4" FH SMS
- Other:** No. 910RC: Narrow strike for mounting on door, catch in jamb
No. 911RC: Wide strike for mounting on jamb, catch in door
- Features:**
- 1/4" radius corners for easy mortise installation
 - Dual adjustment for door clearance and holding strength

No.	Body Size	Strike Size	Weight	ANSI A156.9
910RC	1" x 2 1/8"	1 1/16" x 2 1/8"	0.2 lbs.	B03017
911RC	1" x 2 1/8"	1 3/8" x 2 1/8"	0.2 lbs.	B03017



Door Edge Filler Plate No. DF86

- Material:** Steel
Finishes: Prime coat
Fastener: 2 ea. #12-24x $\frac{1}{2}$ " FH MS
Other: For gov. 86 mortise lock face

No.	Size	Weight	Pack Quantity
DF86	1 $\frac{1}{4}$ " x 8" x $\frac{3}{16}$ "	11.9 lbs./25	25



Frame Hinge Filler Plate No. DFF4

- Material:** Steel
Finishes: Prime coat
Fastener: 2 ea. #12-24x $\frac{1}{2}$ " FH MS
Other: For 1 $\frac{3}{4}$ " rabbet frames

No.	Size	Weight	Pack Quantity
DFF4	1 $\frac{5}{8}$ " x 4 $\frac{1}{2}$ "	6.8 lbs./25	25

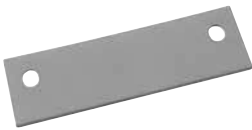

Frame Hinge Filler Plate No. DFF5

- Material:** Steel
Finishes: Prime coat
Fastener: 2 ea. #12-24x $\frac{1}{2}$ " FH MS
Other: For 1 $\frac{3}{4}$ " rabbet frames

No.	Size	Weight	Pack Quantity
DFF5	1 $\frac{5}{8}$ " x 5"	7.9 lbs./25	25



Beveled Door Hinge Filler Plate No. DHF4B

- Material:** Steel
Finishes: Prime coat
Fastener: 2 ea. #12-24x $\frac{1}{2}$ " FH MS
Other: For handed doors (beveled)

No.	Size	Weight	Pack Quantity
DHF4B	1 $\frac{1}{2}$ " x 4 $\frac{1}{2}$ "	6.4 lbs./25	25

ASSA ABLOY
Opening Solutions

Experience a safer
and more open world

800-458-2424 | www.assaabloydooraccessories.us
Check the web site for the up-to-date catalog

Copyright © 2012-2020, ASSA ABLOY Accessories and Door Controls Group, Inc. All rights reserved. Reproduction in whole or in part without the express written permission of ASSA ABLOY Accessories and Door Controls Group, Inc. is prohibited.



Square Door Hinge Filler Plate No. DHF4S

- Material:** Steel
- Finishes:** Prime coat
- Fastener:** 2 ea. #12 - 24 x 1/2" FH MS
- Other:** For non-handed doors (square edge)

No.	Size	Weight	Pack Quantity
DHF4S	1 3/4" x 4 1/2"	7.7 lbs./25	25



Beveled Door Hinge Filler Plate No. DHF5B

- Material:** Steel
- Finishes:** Prime coat
- Fastener:** 2 ea. #12 - 24 x 1/2" FH MS
- Other:** For handed doors (beveled)

No.	Size	Weight	Pack Quantity
DHF5B	1 1/2" x 5"	7.2 lbs./25	25

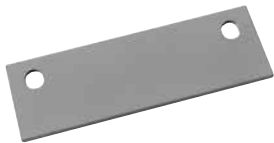

Square Door Hinge Filler Plate No. DHF5S

- Material:** Steel
- Finishes:** Prime coat
- Fastener:** 2 ea. #12 - 24 x 1/2" FH MS
- Other:** For non-handed doors (square edge)

No.	Size	Weight	Pack Quantity
DHF5S	1 3/4" x 5"	8.5 lbs./25	25



Flush Bolt Filler Plate No. FBF48

- Material:** Steel
- Finishes:** Prime coat
- Fastener:** 2 ea. #8 - 32 x 1/2" FH MS

No.	Size	Weight	Pack Quantity
FBF48	1" x 6 3/4"	6.4 lbs./25	25



Flush Bolt Strike Filler Plate No. FBS48

Material: Steel
Finishes: Prime coat
Fastener: 2 ea. #8-32 x 1/2" FH MS

No.	Size	Weight	Pack Quantity
FBS48	1 ⁵ / ₁₆ " x 2 ¹ / ₄ "	1.3 lbs./25	25

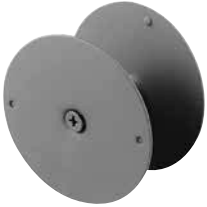

Door Face Filler Plate No. FC161

Material: Steel
Finishes: Prime coat
Fastener: Sex bolt and sleeve
Other: To cover up to 2¹/₈" lock hole

No.	Size	Weight	Pack Quantity
FC161	2 ⁵ / ₈ " dia.	4.0 lbs./25	25



Door Face Filler Plate No. FD160

Material: Steel
Finishes: Prime coat
Fastener: Sex bolt and sleeve
Other: To cover up to 1¹/₂" lock hole

No.	Size	Weight	Pack Quantity
FD160	1 ³ / ₄ " dia.	2.0 lbs./25	25

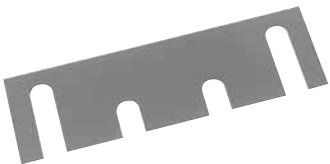

4¹/₂" Hinge Shim – .028" Thick No. HS42

Material: Steel
Finishes: Galvanized coat

No.	Size	Weight	Pack Quantity
HS42	1 ⁷ / ₁₆ " x 4 ¹ / ₂ "	2.2 lbs./50	50

ASSA ABLOY
Opening Solutions

Experience a safer
and more open world

800-458-2424 | www.assaabloydooraccessories.us
Check the web site for the up-to-date catalog

Copyright © 2012-2020, ASSA ABLOY Accessories and Door Controls Group, Inc. All rights reserved. Reproduction in whole or in part without the express written permission of ASSA ABLOY Accessories and Door Controls Group, Inc. is prohibited.



4 1/2" Hinge Shim – .065" Thick No. HS44

Material: Steel
Finishes: Galvanized coat

No.	Size	Weight	Pack Quantity
HS44	1 7/16" x 4 1/2"	4.4 lbs./50	50

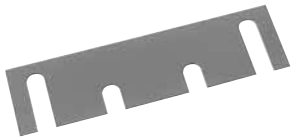

5" Hinge Shim – .028" Thick No. HS52

Material: Steel
Finishes: Galvanized coat

No.	Size	Weight	Pack Quantity
HS52	1 7/16" x 5"	2.3 lbs./50	50



5" Hinge Shim – .065" Thick No. HS54

Material: Steel
Finishes: Galvanized coat

No.	Size	Weight	Pack Quantity
HS54	1 7/16" x 5"	4.5 lbs./50	50



Latch Adapter Plate No. LA86

Material: Steel
Finishes: Prime coat
Fastener: 2 ea. #12 - 24 x 1/2" FH MS
Other: Change 86 cutout to 161 template

No.	Size	Weight	Pack Quantity
LA86	1 1/4" x 8"	7.5 lbs./25	25



Door Edge Filler Plate No. LF161

Material: Steel
Finishes: Prime coat
Fastener: 2 ea. #8-32 x 1/2" FH MS
Other: For gov. 161 latch

No.	Size	Weight	Pack Quantity
LF161	1 1/8" x 2 1/4"	2.5 lbs./25	25



Strike Filler Plate No. SF160

Material: Steel
Finishes: Prime coat
Fastener: 2 ea. #8-32 x 1/2" FH MS
Other: For gov. 160 latch

No.	Size	Weight	Pack Quantity
SF160	1 1/8" x 2 3/4"	2.1 lbs./25	25

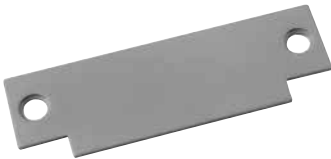

Strike Filler Plate No. SFASA

Material: Steel
Finishes: Prime coat
Fastener: 2 ea. #12-24 x 1/2" FH MS
Other: For ASA strike

No.	Size	Weight	Pack Quantity
SFASA	1 1/4" x 4 7/8"	4.9 lbs./25	25



Strike Filler Plate No. SFB160

Material: Steel
Finishes: Prime coat
Fastener: 2 ea. #8-32 x 1/2" FH MS
Other: For Schlage "B" lock and other dead lock strikes

No.	Size	Weight	Pack Quantity
SFB160	1 1/8" x 2 3/4"	1.9 lbs./25	25

ASSA ABLOY
Opening Solutions

Experience a safer
and more open world

800-458-2424 | www.assaabloydooraccessories.us
Check the web site for the up-to-date catalog

Copyright © 2012-2020, ASSA ABLOY Accessories and Door Controls Group, Inc. All rights reserved. Reproduction in whole or in part without the express written permission of ASSA ABLOY Accessories and Door Controls Group, Inc. is prohibited.

The ASSA ABLOY Group is the global leader in access solutions.
Every day, we help billions of people experience a more open world.

ASSA ABLOY
Opening Solutions

ASSA ABLOY Opening Solutions leads the development within door openings and products for access solutions in homes, businesses and institutions. Our offering includes doors, frames, door and window hardware, mechanical and smart locks, access control and service.



ASSA ABLOY Opening Solutions
Architectural Accessories Group
300 Main Street
Rockwood, Pennsylvania 15557
Phone: 800 458 2424
Fax: 800 922 9212
www.assaabloydooraccessories.us
orders.rockwood@assaabloy.com

ASSA ABLOY Opening Solutions
Door Security Solutions Canada
160 Four Valley Drive
Vaughan, ON L4K 4T9
www.assaabloydss.ca
1 800 461 3007