

Condensed Catalog



introduction

Yale Locks & Hardware is solely dedicated to the engineering, design, and manufacture of builders' hardware. Yale® offers a complete line of locksets and door control hardware designed for the needs of the architect and end user.

In addition to superior product quality, *Yale* offers a mix of product expertise that is unsurpassed in the hardware industry. A constant exchange of information among lock specialists, exit hardware professionals and door closer experts ensures comprehensive door hardware capability. It is an important reservoir of knowledge that is available for every architectural specification you prepare.

Our Technical Product Specialists can provide answers to all your hardware applications questions, from a special high school exit device application to deep frame reveals or cylinder matching in a 1920 restoration project. The *Yale* Customer Service Department provides answers on availability and order tracking quickly to ensure on-time delivery to the job site. A toll-free call can take care of all your concerns.

Yale education programs, instructed by veteran hardware professionals, are considered the best in the industry. Hundreds of distributors, specifiers, locksmiths, and owners annually attend *Yale* Product Maintenance Schools, Architectural Hardware Schools and special traveling presentations on keying and other hardware subjects.

This catalog is a condensed version of the *Yale* library of catalogs. *Yale* provides complete catalogs on more than 2,000 door opening hardware items.

For further information contact your sales representative, call toll-free at 1-800-438-1951, or visit us at www.yalelocks.com.

americans with disabilities act (a.d.a.)

Title III of the Americans With Disabilities Act (A.D.A.), Public Law 101-336, became effective on January 28, 1992. The A.D.A. "prohibits discrimination on the basis of disability by private entities in places of public accommodation and that the commercial facilities be designed and constructed so as to be readily accessible to and usable by persons with disabilities..." (Federal Register, Vol. 56, No. 144/7-26-91/Rules and Regulations).



Yale locksets and door controls that comply with A.D.A. requirements are indicated as such by the accessibility symbol in this catalog.

contents

- Introduction 2
- Reflections® Decorative Levers 3
- Mortise Locksets 4
- Mortise Lock Trim 5-6
- Cylindrical Locksets 7-15
- Monolocks 16
- Auxiliary Locks 17
- Lockset Functions 18-23
- Multi-point Locking Systems 24
- Exit Devices 25-27
- Exit Device Trim 28-29
- Cylinders and Keying 30
- Door Controls 31-33
- Electrified Products 34-39
- Residential 40-49

microshield®

Yale locks and exit devices are available with *MicroShield* antimicrobial coating. *MicroShield* is a revolutionary hardware finish coating, using a silver ion based technology, which inhibits the growth of bacteria, algae, yeast, fungus, mold and mildew. *MicroShield* is non-toxic and lasts for the lifetime of the finish to which it is applied. To order, suffix option code "YMS".



Note: *MicroShield* coating may vary finish color from architectural standards. Locksets and exit devices available with *MicroShield* will be indicated as such by the *MicroShield* icon. *MicroShield* is not intended as a substitute for traditional infection control programs such as hand hygiene or use of disinfectants. Coated products must still be cleaned to insure the surfaces will be free of destructive microbes. *Yale* makes no representations or warranties, express or implied, as to the efficacy of *MicroShield*.



**8800 Series
Mortise Locksets
See Page 4**



**5400LN Series
Lever Locksets
See Page 7**



**D Series
Cylindrical Deadbolts
See Page 17**



**7100/7200 Series
Exit Devices
See Page 25**

Reflections® stylized door levers

For more than 150 years, Yale has distinguished itself as an innovative designer and manufacturer of locksets and door control hardware. That tradition continues with Reflections® by Yale®, a comprehensive line of highly stylized door levers and coordinating hardware.

This premier product series is available for Yale® 8800RL mortise locks, RL tubular locks and exit device trim, creating a continuity of beautiful design throughout a building.

The *Reflections* offering consists of 30 dynamic and distinctive levers within six groups: Hudson, Danube, Seine, Thames, Victoria and Niagara. Each captures a unique beauty and spirit of design unlike any other. These exquisite levers offer Yale quality and exceptional elegance to a variety of high-end commercial projects, including office buildings, museums, upscale hotels and resorts, and large multi-use projects such as apartment and condominium complexes.

Let Reflections® by Yale® inspire your vision of great design.

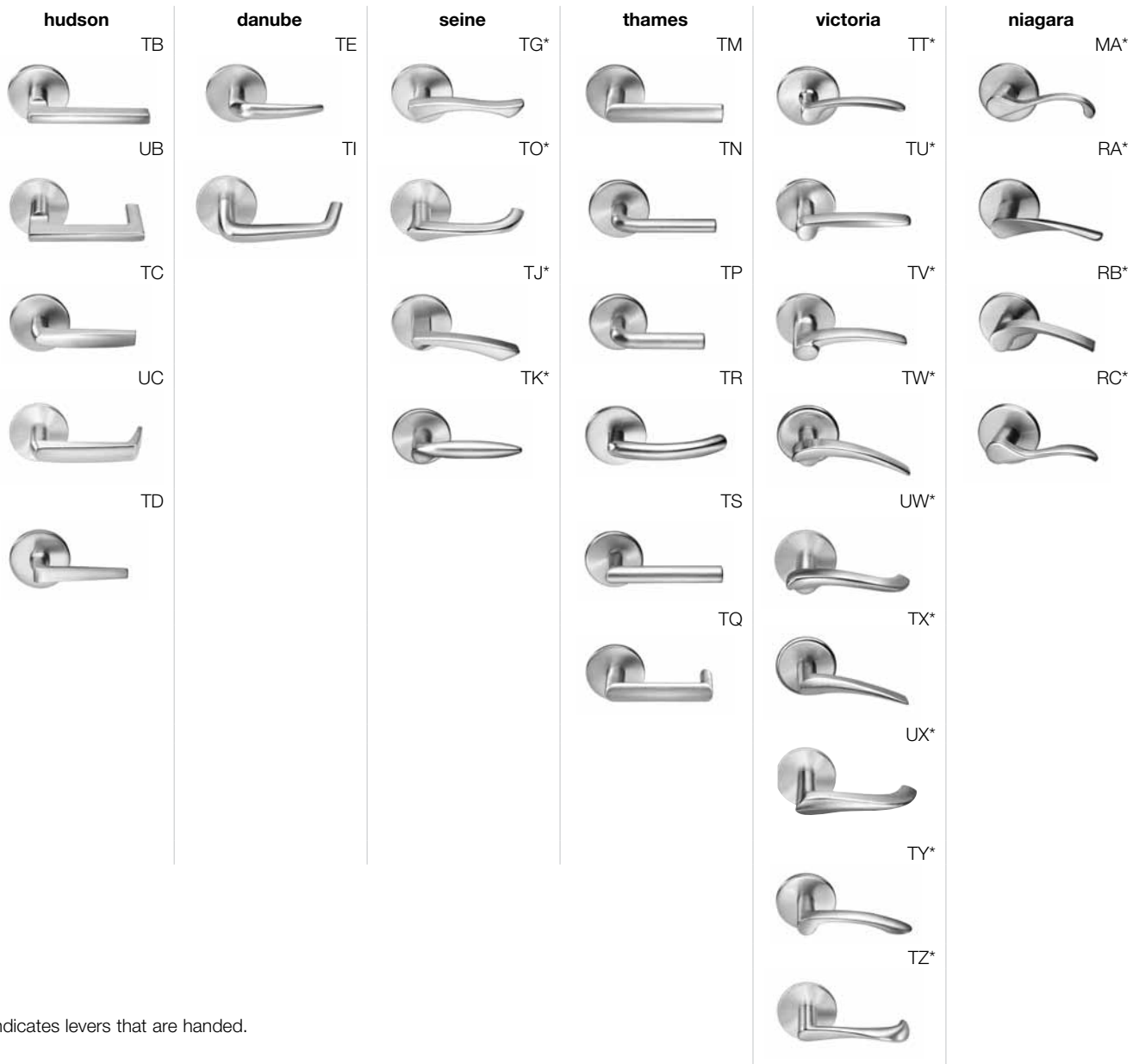

*Indicates levers that are handed.



mortise locksets



8800 series mortise locksets

 The 8800 provides steadfast dependability and is the choice of architects and owners who require superior performance in even the toughest applications. As a longtime industry standard of quality, the Yale® steel case mortise lock continues to provide the highest level of security. This mortise lock brings versatility as well as uncompromising strength and durability. With quick lever handing and a tamper-proof, quick-reversible latchbolt, lockset handing takes only seconds. Options, such as an occupancy indicator for privacy functions, provide flexibility and ease of use.

When it comes to strength, the *Yale* 8800 series brings a new measure of security to the door. Its 1" throw stainless steel deadbolt extends further back into the reinforced steel case when in the locked position, providing added stability and resistance to abuse. Solid trim packages also provide deterrence to vandalism, making the 8800 series number one in the total opening package. See pages 34-35 for electrified information.



features

- ANSI/BHMA:** A156.13, Series 1000 Grade 1 
- UL-cUL:** UL-cUL fire-rated up to 3 hours
- Windstorm:** Certified (refer to local codes)  Hurricane
- Lock Case and Cover:** Heavy-gauge wrought steel, zinc-plated, dichromated
- Backset:** 2-3/4" only
- Deadbolt:** Stainless steel, 1" throw
- Latchbolt:** 2 pc - stainless steel, mechanical anti-friction 3/4" throw
- Guardbolt:** Non-handed. Deadlocks latchbolt when door is closed
- Armor Front:** 8" x 1-1/4"
- Rabbeted Doors:** Non-handed for 1/2" rabbet
- Lead Shielding:** Available to order
- Cylinders:** Brass, 6-pin, keyed-random cylinder with two keys furnished standard, 7-pin available to order. For other cylinder and keying options see page 30.
- Reversibility:** Locksets are handed and offer quick field reversibility
- Strikes:** 1-1/4" Non-handed curved lip standard; other curved lip and flat available to order
- Finishes:** Available in 16 finishes
- Warranty:** 10-year mechanical

heavy-duty escutcheon trim

8800 series locks with escutcheon trim are provided standard with the Camden (CN) escutcheon. This zinc die cast escutcheon features one-piece casting for superior strength.

Locks with this escutcheon are ANSI/BHMA certified operational and security Grade 1 and will retrofit to existing *Yale* escutcheon preps. The aesthetics of the CN escutcheon provide a design continuum with *Yale* exit device trim for a consistent look throughout the facility.

mortise lock trim

8800FL series standard lever trim
All through-bolted.



Arcadia*		Augusta	
ARR	AR x CN	AUR	AU x CN
Carmel		Jefferson	
CRR	CRR x CN	JNR	JN x CN
Monroe		Pacific Beach	
MOR	MO x CN	PBR	PB x CN
Pinehurst		Virginia	
PNR	PN x CN	VIR	VI x CN

* Indicates levers that are handed.



8800 series standard knob trim
All through-bolted.

Copenhagen	
COR	CO x CN
Litchfield	
LFR	LF x CN

8800FL designer trim
All through-bolted.

Hampton	
HAR1	HAE1

optional designer rose
and escutcheon

R2	E2
HAR1	HAE1



mortise lock trim

Reflections® decorative levers

Yale® 8800RL mortise locks are available with *Reflections* lever trim, a comprehensive line of highly stylized lever handles. *Reflections* lever handles are made from solid brass or stainless steel and can withstand years of abuse. Available in a multitude of finishes, the levers complement any wood grain or other door exterior. Each lever is hand-polished and specially designed for ergonomics and style.

features

- All 8800RL series lever trims feature through-bolted installation. For sectional trims, this ensures positive alignment of the trim with the lock case.
- All outside trim is held in place by threaded posts. For sectional trims, the posts fit through holes in the lock case and are secured by through-bolts from the inside trim. For escutcheon trims, the posts fit through the door and are secured by through-bolts from the inside trim.
- Outside escutcheon trims have no visible screws - a great deterrent to vandalism.
- 8800RL mortise locks feature an internal heavy-duty spring cartridge which prevents lever sag.
- All 8800RL trims are UL-cUL listed for fire door applications.
- Available for 1-3/4" to 3-1/4" thick doors.
- Lever designs are available as shown on page 3.

Reflections® roses

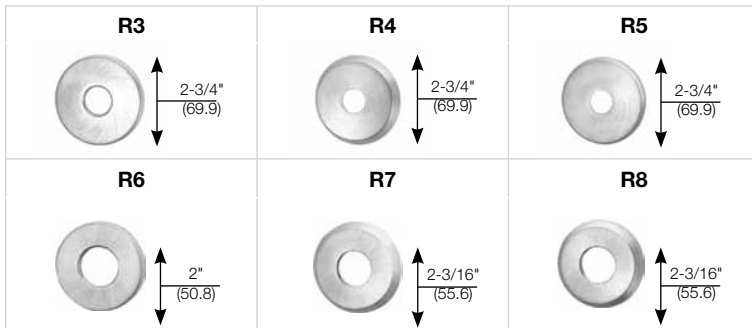

Reflections® escutcheons





cylindrical locksets

5400LN series cylindrical lever locksets



 Designed for industrial, commercial and institutional use, the *Yale* 5400LN offers no compromise when it comes to reliability and performance. With construction features such as our Free Wheeling lever mechanism, wear-resistant chassis plates, heavy-duty return springs and patented (Patent No. 6,131,970) door thickness adjustment, it's easy to see why it's a favorite among those who demand the highest standard of product quality. See pages 34-35 for electrified information.

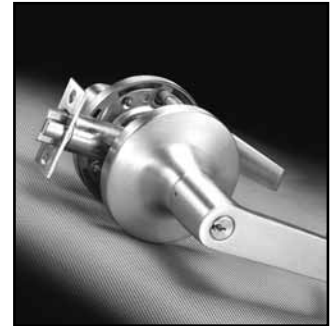

All 5400LN functions feature the Free Wheeling lever mechanism. When the outside lever is locked, it will rotate freely up and down while remaining securely locked.



features

- ANSI/BHMA:** A156.2, Series 4000 Grade 1 
- UL-cUL:** UL-cUL fire-rated up to 3 hours
- Windstorm:** Certified (refer to local codes)  Hurricane
- Mechanism:** Heavy-gauge steel, zinc-plated, dichromated
- Backset:** 2-3/4" standard; 3-3/4" or 5" extension link available to order
- Latchbolt:** 1/2" stainless steel throw standard; 3/4" throw available to order
- Guardbolt:** Deadlocks latchbolt when door is closed; standard on all locking functions
- Door Thickness:** Adjustable from 1-3/4" to 2". Available to 2-1/4" doors to order.
- Fronts:** 2-1/4" x 1-1/8" beveled standard; flat fronts available to order
- Lead Shielding:** Available to order
- Cylinders:** Brass, 6-pin, keyed-random cylinder with two keys furnished standard, 7-pin available to order. For other cylinder and keying options, see page 30.
- Reversibility:** Non-handed
- Strikes:** 1-1/4" curved lip for 1-3/4" door standard; other lip lengths available to order; all reversible
- Finishes:** Available in 12 finishes
- Warranty:** 7-year mechanical

5400LN series trim



Levers available to accept small format interchangeable cores and large format interchangeable cores from ASSA®, Medeco® and Schlage®. Fixed core cylinders available with keyways from Corbin®, Corbin Russwin®, Russwin®, Sargent® and Schlage®.





cylindrical locksets

5400 series cylindrical knob locksets

Yale® highest-quality knob locksets offer the finest cylindrical lock mechanisms available. The 5400 series is assembled with superbly engineered components of high-grade materials for long-lasting reliability. Manufactured for the industrial, commercial and institutional markets, this lockset features security, dependability and versatility in attractive designs and finishes.



features

- ANSI/BHMA:** A156.2, Series 4000 Grade 1 
- UL-cUL:** UL-cUL fire-rated up to 3 hours
- Windstorm:** Certified (refer to local codes)  Hurricane
- Mechanism:** 5400 series heavy-gauge steel, zinc-plated, dichromated
- Backset:** 2-3/4" standard; 3-3/4" or extension links thru 42" available to order
- Latchbolt:** 1/2" stainless steel throw standard; 5/8" and 3/4" throw available to order
- Guardbolt:** Deadlocks latchbolt when door is closed; standard on all locking functions
- Door Thickness:** Adjustable from 1-3/8" to 2" standard; 1-1/4" to 1-3/8" or 2" to 2-1/4" available to order for most trim
- Fronts:** 2-1/4" x 1-1/8" beveled standard; flat fronts available to order
- Lead Shielding:** Available to order
- Cylinders:** Brass, 6-pin, keyed-random cylinder with two keys furnished standard, 7-pin available to order. For other cylinder and keying options, see page 30.
- Reversibility:** Non-handed
 - Strikes:** 1-1/4" curved lip for 1-3/4" door standard; other lip lengths available to order; all reversible
 - Finishes:** Available in 15 finishes
 - Warranty:** 1-year mechanical

5400 series trim

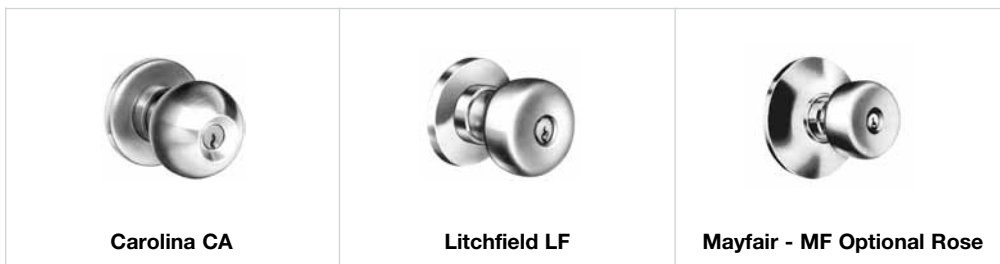

cylindrical locksets

5300LN series cylindrical lever locksets



 This revolutionary lockset boasts features such as a vandal-resistant Free Wheeling lever mechanism and a patented adjustable door thickness design (Patent No. 6,131,970) that makes installation a breeze. Through-bolting provides a secure fit that resists rattling and shaking. With three lever designs and twelve finishes, you have the freedom and ability to match any decor. See pages 34-35 for electrified information.



All 5300LN functions feature the Free Wheeling lever mechanism. When the outside lever is locked, it will rotate freely up and down while remaining securely locked.



features

- ANSI/BHMA:** A156.2, Series 4000 Grade 2 
- UL-cUL:** UL-cUL fire-rated up to 3 hours
- Windstorm:** Certified (refer to local codes)  Hurricane
- Mechanism:** Heavy-gauge steel, zinc-plated, dichromated
- Backset:** 2-3/4" standard; 2-3/8", 3-3/4" or 5" extension links available to order
- Latchbolt:** 1/2" stainless steel throw
- Guardbolt:** Deadlocks latchbolt when door is closed; standard on all locking functions
- Door Thickness:** Adjustable from 1-3/4" to 2". Available for 1-3/8" or 2-1/4" doors to order.
- Fronts:** Universal for both flat and beveled door edges
- Lead Shielding:** Not available
- Cylinders:** Brass, 6-pin, keyed-random cylinder with two keys furnished standard, 7-pin not available. For other cylinder and keying options see page 30.
- Reversibility:** Non-handed
 - Strikes:** 1-1/4" curved lip for 1-3/4" door standard; other lip lengths available to order; all reversible
 - Finishes:** Available in 12 finishes
 - Warranty:** 5-year mechanical

5300LN series trim



Levers available to accept small format interchangeable cores and large format interchangeable cores from ASSA®, Medeco® and Schlage®. Fixed core cylinders available with keyways from Corbin®, Corbin Russwin®, Russwin®, Sargent® and Schlage®.



cylindrical locksets

4800LN series lever interconnected locksets

 The Yale® 4800LN series interconnected locksets combine our key-in-lever locksets with the added safety and security of a deadbolt. From the inside, both the latchbolt and the deadbolt are retracted simultaneously in a single motion for a quick and easy egress. The 4800LN series is ideal for multi-family dwellings, assisted living facilities, office and light-duty commercial use.



features

- UL-cUL:** UL-cUL fire-rated up to 1-1/2 hours
- Windstorm:** Certified (refer to local codes)  Hurricane
- Mechanism:** Heavy-gauge steel, zinc-plated, dichromated
- Backset:** 2-3/4" standard; 2-3/8" available to order
- Deadbolt:** Face removable standard for quick re-keying
- Latchbolt:** 1/2" stainless steel throw
- Guardbolt:** Deadlocks latchbolt when door is closed; standard on all locking functions
- Door Thickness:** Adjustable from 1-3/8" to 2"
- Fronts:** Square corner front standard; round corner available to order
- Cylinders:** Brass, 6-pin, keyed-random cylinder with two keys furnished standard, 7-pin not available. For other cylinder and keying options see page 30.
- Reversibility:** Non-handed
- Strikes:** 1-1/4" curved lip T-strike standard for lockset, 1-1/8" x 2-3/4" standard for deadbolt; others available to order
- Finishes:** Available in 7 finishes
- Warranty:** 1-year mechanical

4800LN series trim



cylindrical locksets



4700(LN) series cylindrical locksets

Yale® 4700(LN) cylindrical locks are the ideal choice for a wide variety of commercial applications where consistent quality, ease of use and installation are required at an economical price. The 4700(LN) series is certified to ANSI/BHMA Grade 1 standards and is UL fire-listed for all functions ensuring reliability and peace of mind. See pages 34-35 for electrified information.



All 4700LN functions feature the Free Wheeling lever mechanism. When the outside lever is locked, it will rotate freely up and down while remaining securely locked.

features

- ANSI/BHMA:** A156.2, Series 4000 Grade 1 
- UL-cUL:** UL-cUL fire-rated up to 3 hours
- Windstorm:** 4700LN Certified (refer to local codes)  Hurricane
- Mechanism:** Heavy-gauge steel, die-cast, zinc-plated, chromated
- Backset:** 2-3/4" standard
- Latchbolt:** 1/2" stainless steel throw standard
- Guardbolt:** Deadlocks latchbolt when door is closed; standard on all locking functions
- Door Thickness:** 4700LN adjustable from 1-3/4" to 2", available for 1-3/8" or 2-1/4" doors to order. 4700 adjustable from 1-3/4" to 2"
- Fronts:** 2-1/4" x 1-1/8" beveled standard; flat fronts available to order
- Cylinders:** Brass, 6-pin, keyed-random cylinder with two keys furnished standard, 7-pin not available. For other cylinder and keying options see page 30.
- Reversibility:** Non-handed
- Strikes:** ANSI strike 4-7/8" x 1-1/4" x 1-1/4" lip to center supplied standard. Optional T-strike available to order for 4700LN.
- Finishes:** 4700LN available in 7 finishes, 4700 available in satin stainless steel (630) only.
- Warranty:** 5-year mechanical

4700 series trim



4700LN series trim

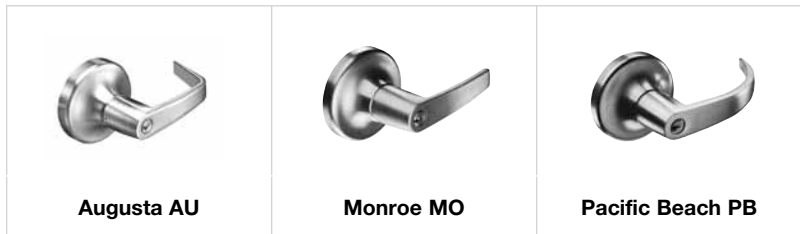

Levers and knob available to accept 6- and 7- pin small format interchangeable cores. Fixed core cylinders available with keyways from Corbin®, Corbin Russwin®, Russwin®, Sargent® and Schlage®.



cylindrical locksets



4600(LN) series cylindrical locksets

Yale® 4600(LN) cylindrical locks are the ideal choice for a wide variety of commercial applications where consistent quality, ease of use and installation are required at an economical price. The 4600(LN) series is certified to ANSI/BHMA Grade 2 standards and is UL fire-listed for all functions ensuring reliability and peace of mind.

4600LN cylindrical lever locks are supplied with optional through-bolts. Installation of through-bolts is at the discretion of the installer.



features

- ANSI/BHMA:** A156.2, Series 4000 Grade 2 
- UL-cUL:** UL-cUL fire rated up to 3 hours
- Windstorm:** 4600LN Certified (refer to local codes)  Hurricane
- Mechanism:** Heavy-gauge steel, zinc plated, dichromated
- Backset:** 2-3/4" standard; 2-3/8" to order
- Latchbolt:** 1/2" stainless steel throw
- Guardbolt:** Deadlocks latchbolt when door is closed; standard on all locking functions
- Door Thickness:** Adjustable from 1-3/8" to 1-3/4"
- Fronts:** Universal for both flat and beveled door edges
- Cylinders:** Brass, 6-pin, keyed-random cylinder with two keys furnished standard, 7-pin not available. For other cylinder and keying options see page 30.
- Reversibility:** Non-handed
- Strikes:** 1-1/4" curved lip for 1-3/4" door standard; other lip lengths to special order; all reversible
- Finishes:** Available in 6 finishes
- Warranty:** 3-year mechanical

4600 series trim



4600LN series trim



Levers and knob available to accept 6- and 7-pin small format interchangeable cores. Fixed core cylinders available with keyways from Corbin®, Corbin Russwin®, Russwin®, Sargent® and Schlage®.

cylindrical locksets

4300LN series tubular lever locksets



An economical, light/medium-duty lever lockset that provides an outstanding combination of value and performance. It is the ideal lever lockset for light commercial and heavy-duty residential applications, including multi-family housing units, nursing homes, retail complexes, restaurants and hotels.



features

- ANSI/BHMA:** A156.2, Series 4000 Grade 2 
- UL-cUL:** UL-cUL fire-rated up to 1-1/2 hours
- Mechanism:** Heavy-gauge steel, zinc-plated, dichromated
- Backset:** 2-3/4" standard; 2-3/8" available to order
- Latchbolt:** 1/2" stainless steel throw
- Guardbolt:** Deadlocks latchbolt when door is closed; standard on all functions
- Door Thickness:** Adjustable from 1-3/8" to 1-3/4"
- Fronts:** Square corner front standard; round corner available to order
- Cylinders:** Brass, 6-pin, keyed-random cylinder with two keys furnished standard, 7-pin not available. For other cylinder and keying options, see page 30.
- Reversibility:** Non-handed
- Strikes:** 1-1/4" curved lip T-strike standard; ANSI and full lip strikes available to order
- Finishes:** Available in 7 finishes
- Warranty:** 1-year mechanical

4300LN series trim





cylindrical locksets

4300 series tubular knob locksets

An economical, light/medium-duty knob lockset that provides an outstanding combination of value and performance. It is the ideal knob lockset for light commercial and heavy-duty residential applications, including multi-family housing units, nursing homes, retail complexes, restaurants, and hotels.



features

- ANSI/BHMA:** A156.2, Series 4000 Grade 2 
- UL-cUL:** UL-cUL fire-rated up to 1-1/2 hours
- Mechanism:** Heavy-gauge steel, zinc-plated, dichromated
- Backset:** 2-3/4" standard; 2-3/8" available to order
- Latchbolt:** 1/2" stainless steel throw
- Guardbolt:** Deadlocks latchbolt when door is closed; standard on all functions
- Door Thickness:** Adjustable from 1-3/8" to 1-3/4"
- Fronts:** Square corner fronts standard; round corner available to order
- Cylinders:** Brass, 6-pin, keyed-random cylinder with two keys furnished standard, 7-pin not available. For other cylinder and keying options, see page 30.
- Reversibility:** Non-handed
- Strikes:** 1-1/4" curved lip T-strike standard; ANSI and full lip strikes available to order
- Finishes:** Available in 2 finishes
- Warranty:** 1-year mechanical

4300 series trim



RL series tubular locksets

RL series tubular locks are designed to work with Yale® Reflections® decorative levers. Engineered for ease of installation with the quality you expect from Yale, the RL series will meet and exceed the expectations of the most demanding architects and design professionals. Ideal interior applications include hospitality, multi-use facilities, apartments and condominiums.



features

- UL-cUL:** Available UL-cUL fire-rated up to 3 hours
- Backset:** 2-3/4" standard or 2-3/8" available to order
- Latchbolt:** 1/2" brass throw
- Door Thickness:** Adjustable from 1-3/8" to 1-3/4"
- Fronts:** 2-3/4" backset furnished standard with a 1-1/8" wide square corner front. 2-3/8" backset furnished standard with a 1" wide square corner front.
- Reversibility:** Non-handed
- Strikes:** 1-1/4" curved lip T-strike standard; ANSI and full lip strikes available to order
- Finishes:** Available in 14 finishes
- Warranty:** 1-year mechanical

RL series trim

See page 3 for Reflections® decorative levers.



monolocks

6400LN series monolocks

 Based on the Yale® 5400LN Grade 1 cylindrical lockset, the 6400LN Monolock continues the tradition of quality and dependability as a preassembled lock series designed to retrofit existing Yale® Monolock as well as Corbin Russwin Unit Lock and Falcon® Retrofit Lock installations with 1-3/4" latch height.



All 6400LN functions feature the Free Wheeling lever mechanism. When the outside lever is locked, it will rotate freely up and down while remaining securely locked.



features

- UL-cUL:** UL-cUL fire-rated up to 1-1/2 hours
- Mechanism:** Heavy-gauge steel, zinc-plated, dichromated
- Backset:** 2-3/4"
- Latchbolt:** 1/2" stainless steel throw
- Guardbolt:** Deadlocks latchbolt when door is closed; standard on all locking functions
- Door Thickness:** 1-3/4" only
- Lead Shielding:** Available to order
- Cylinders:** Brass, 6-pin, keyed-random cylinder with two keys furnished standard, 7-pin available to order. For other cylinder and keying options, see page 30.
- Reversibility:** Handing must be specified for all functions and designs
- Strikes:** 1-1/4" lip ANSI strike supplied; other lip lengths and strikes available to order; all reversible
- Finishes:** Available in 1 finish
- Warranty:** 7-year mechanical

6400LN series trim



Levers available to accept small format interchangeable cores and large format interchangeable cores from ASSA®, Medeco® and Schlage®. Fixed core cylinders available with keyways from Corbin®, Corbin Russwin®, Russwin®, Sargent® and Schlage®.

auxiliary locks

D100 series cylindrical deadbolts

ANSI/BHMA:	A156.5, Grade 1 
UL-cUL:	UL-cUL fire-rated up to and including 3 hours. cUL fire-rated for wood doors up to 90 minutes.
Backset:	2-3/4" or 2-3/8" available to order
Door Preparation:	Can be installed on metal doors prepared to ANSI/BHMA A156.115 Specifications
Cross Bore Wood Doors:	Standard - 2-1/8" diameter
Edge Bore:	1" diameter
Deadbolt:	1" throw, solid steel deadbolt with hardened, free spinning, steel pin insert.
Door Thickness:	1-3/8" to 1-3/4" standard
Cylinders:	Brass, 6-pin, keyed-random cylinder with two keys furnished standard. For other cylinder and keying options, see page 30.
Reversibility:	Non-handed
Strikes:	2-3/4" x 1-1/8" metal and wood door strikes with strike reinforcement standard
Finishes:	Available in 7 finishes
Warranty:	1-year mechanical



D200 series cylindrical deadbolts

ANSI/BHMA:	A156.5, Grade 2 
UL-cUL:	UL-cUL fire-rated up to and including 3 hours. cUL fire-rated for wood doors up to 90 minutes.
Backset:	2-3/4" or 2-3/8" available to order
Door Preparation:	Can be installed on metal doors prepared to ANSI/BHMA A156.115 Specifications
Cross Bore Wood Doors:	Standard - 2-1/8" diameter
Edge Bore:	1" diameter
Deadbolt:	1" throw, solid steel deadbolt with hardened, free spinning, steel pin insert.
Door Thickness:	1-3/8" to 1-3/4" standard
Cylinders:	Brass, 6-pin, keyed-random cylinder with two keys furnished standard. LFIC not available. For other cylinder and keying options, see page 30.
Reversibility:	Non-handed
Strikes:	2-3/4" x 1-1/8" metal and wood door strikes with strike reinforcement standard
Finishes:	Available in 7 finishes
Warranty:	1-year mechanical



350 series auxiliary mortise deadlock

UL-cUL:	UL-cUL fire-rated up to and including 3 hours. cUL fire-rated for wood doors up to 90 minutes.
Case:	Heavy wrought steel, zinc-plated and dichromated
Backset:	2-3/4"
Deadbolt:	Laminated stacked steel with hardened pin, 1" throw.
Door Thickness:	1-3/8" to 4" maximum, must be specified
Front:	Universal for both flat and beveled door edges
Thumbturn:	Brass, bronze or stainless steel. Thumbturn attaches directly to lock case for added security.
Cylinder:	Brass, 6-pin, keyed-random cylinder with two keys furnished standard, 7-pin available to order. For other cylinder and keying options, see page 30.
Reversibility:	Non-handed
Finishes:	Available in 15 finishes
Warranty:	1-year mechanical





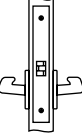
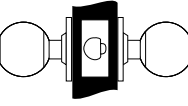
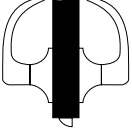
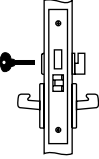
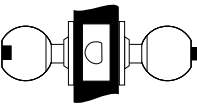

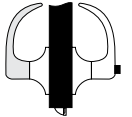
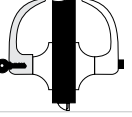
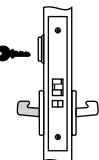
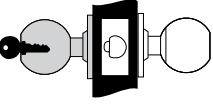
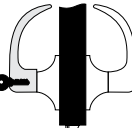
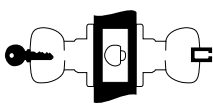
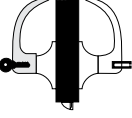
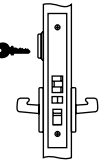
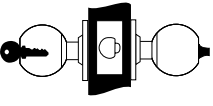
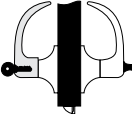
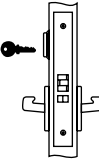
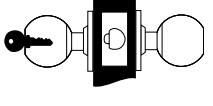
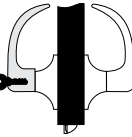

lockset functions

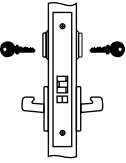
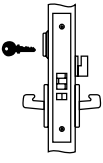
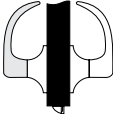
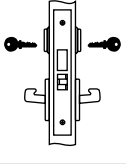
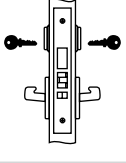
Function/ Application	(ANSI) Model Nos.	Mortise Locksets	(ANSI) Model Nos.	Cylindrical Knob Locksets	(ANSI) Model Nos.	Cylindrical Lever Locksets/ Monolocks
Passage or Closet Latch	(F01) Knob 8801 Levers 8801FL SL8801FL 8801RL		(F75) 5401 4701 4601 4301		(F75) 5401LN 5301LN 4701LN 4601LN 4301LN 6401LN	
Privacy, Bedroom or Bath Lock	(F19) Knob 8802 Levers 8802FL SL8802FL 8802RL		(F76A&B) 5402 4702 4602 4302		(F76A&B) 5402LN 5302LN 4702LN 4602LN 4302LN 6402LN	
Patio or Privacy Lock	N/A	N/A	N/A	N/A	(F77) 5403LN 5303LN 4703LN 6403LN	
Entry Lock	N/A	N/A	N/A	N/A	(F82A&B) 5404LN 5304LN 4704LN 4604LN 6404LN	
Storeroom or Closet Lock	(F07) Knob 8805 Levers 8805FL SL8805FL 8805RL		(F86) 5405 4705 4605 4305		(F86) 5405LN 5305LN 4705LN 4605LN 4305LN 6405LN	
Service Station Lock	N/A	N/A	(F92) 5406		(F92) 5406LN 5306LN 4706LN 6406LN	
Entry Lock	(F04) Knob 8807 Levers 8807FL SL8807FL 8807RL		(F109) 5407 4707 4607 4307		(F109) 5407LN 5307LN 4707LN 4607LN 4307LN 6407LN	
Classroom Lock	(F05) Knob 8808 Levers 8808FL SL8808FL 8808RL		(F84) 5408 4708 4608 4308		(F84) 5408LN 5308LN 4708LN 4608LN 4308LN 6408LN	
	Note: Shaded area denotes rigid lever or knob.		Note: Shaded area denotes rigid knob.		Note: Shaded area denotes Free Wheeling lever (except 4300LN and 4600LN).	

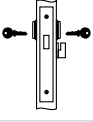
lockset functions

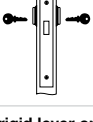
Function/ Application	(ANSI) Model Nos.	Mortise Locksets	(ANSI) Model Nos.	Cylindrical Knob Locksets	(ANSI) Model Nos.	Cylindrical Lever Locksets/ Monolocks
Intruder Latchbolt Lock	(F32) Knob 8808-2 Levers 8808-2FL SL8808-2FL 8808-2RL			N/A		N/A
Classroom or Office Lock (Mortise) Exit Latch (Cylindrical)	Knob 8809 Levers 8809FL SL8809FL 8809RL			N/A	(F89) 5409LN 5309LN 4709LN 6409LN	
Intruder Deadbolt Lock	(F33) Knob 8811-2 Levers 8811-2FL SL8811-2FL 8811-2RL			N/A		N/A
Intruder Deadbolt Lock	(F34) Knob 8812-2 Levers 8812-2FL SL8812-2FL 8812-2RL			N/A		N/A
Classroom Deadlock	(F29) 8813ST			N/A		N/A
Classroom Deadlock	8813ST-2			N/A		N/A
Deadlock	(F18) 8814			N/A		N/A
Deadlock	(F16) 8814-2			N/A		N/A
	Note: Shaded area denotes rigid lever or knob.		Note: Shaded area denotes rigid knob.		Note: Shaded area denotes Free Wheeling lever.	

lockset functions

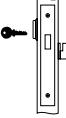
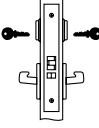
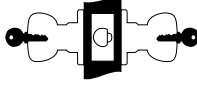
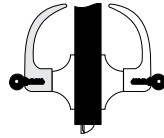
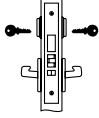
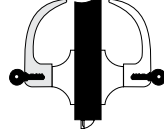
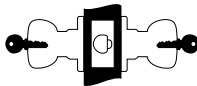
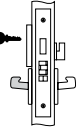
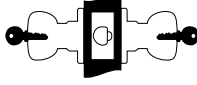
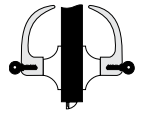
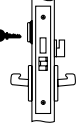
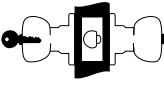
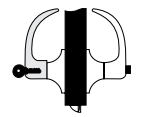
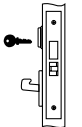
Function/ Application	(ANSI) Model Nos.	Mortise Locksets	(ANSI) Model Nos.	Cylindrical Knob Locksets	(ANSI) Model Nos.	Cylindrical Lever Locksets/ Monolocks
Deadlock	(F17) 8815			N/A		N/A
Apartment, Exit or Public Toilet Lock	(F09) Knob 8817-2 Levers 8817-2FL SL8817-2FL 8817-2RL		(F88) 5417		(F88) 5417LN 6417LN	
Classroom Security Intruder Lock	Knob 8818-2 Levers 8818-2FL SL8818-2FL 8818-2RL			N/A	(F110) 5418LN 5318LN 4718LN 6418LN	
Store Door Lock	N/A		(F91) 5419		N/A	
Hotel Guest Lock	(F15) Knob 8820 Levers 8820FL SL8820FL 8820RL			N/A	N/A	
Communicating Lock	N/A		(F80) 5421		(F80) 5421LN 5321LN 4721LN 6421LN	
Dormitory, Exit or Corridor Lock	(F13) Knob 8822 Levers 8822FL SL8822FL 8822RL		(F90) 5422		(F90) 5422LN 5322LN 4722LN 6422LN	
Storeroom Lock	Knob 8823 Levers 8823FL SL8823FL 8823RL			N/A	N/A	
	Note: Shaded area denotes rigid lever or knob.		Note: Shaded area denotes rigid knob.		Note: Shaded area denotes Free Wheeling lever.	

lockset functions

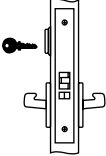
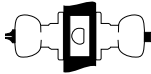
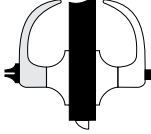
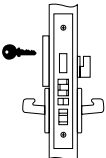
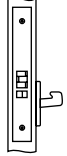
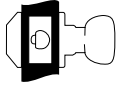
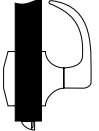
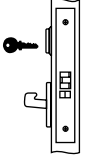
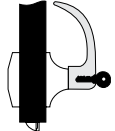
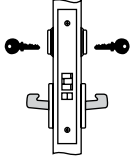
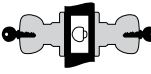
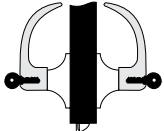
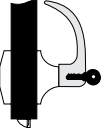
Function/ Application	(ANSI) Model Nos.	Mortise Locksets	(ANSI) Model Nos.	Cylindrical Knob Locksets	(ANSI) Model Nos.	Cylindrical Lever Locksets/ Monolocks
Holdback Lock	Knob 8824 Levers 8824FL SL8824FL 8824RL			N/A		N/A
Privacy Lock	N/A		5425		5425LN 5325LN 4725LN 6425LN	
Hotel/Motel Lock	Knob 8827 Levers 8827FL SL8827FL 8827RL			N/A		N/A
Exit or Communicating Passage Lock	(F31) Knob 8828 Levers 8828FL SL8828FL 8828RL		(F111) 5428		(F111) 5428LN 5328LN 4728LN 4628LN 4328LN 6428LN	
Communicating Classroom or Closet Lock	Knob 8829 Levers 8829FL SL8829FL 8829RL			N/A	(F113) 5429LN 5329LN 4729LN 6429LN	
Asylum or Institutional Lock	(F30) Knob 8830-2 Levers 8830-2FL SL8830-2FL 8830-2RL		(F87) 5430		(F87) 5430LN 5330LN 4730LN 6430LN	
Communicating Storeroom Lock	N/A			N/A	(F112) 5439LN 5339LN 4739LN	
	Note: Shaded area denotes rigid lever or knob.		Note: Shaded area denotes rigid knob.		Note: Shaded area denotes Free Wheeling lever.	



lockset functions

Function/ Application	(ANSI) Model Nos.	Mortise Locksets
Detention Lock	Knob 8831 Lever SL8831FL	
Hotel/Motel Lock	Knob 8832 Levers 8832FL SL8832FL 8832RL	
Exit Lock	Knob 8833 Lever 8833FL 8833RL	
All Purpose Lock	8833-2	
All Purpose Lock	Knob 8834 Lever 8834FL 8834RL	
All Purpose Lock	Knob 8834-2 Lever 8834-2FL 8834-2RL	
Exit Lock	Knob 8835 Lever 8835FL SL8835FL 8835RL	
Note: Shaded area denotes rigid lever or knob.		

Function/ Application	(ANSI) Model Nos.	Cylindrical Interconnected Lever Locksets
Entrance, Single Locking	(F95) 4851LN	
Entrance, Double Locking	(F97) 4871LN	

Function/ Application	(ANSI) Model Nos.	Mortise Locksets
Apartment Corridor Door Lock	(F20) Knob 8847 Levers 8847FL SL8847FL 8847RL	
Room Door Lock	(F21) Knob 8860 Levers 8860FL SL8860FL 8860RL	
Store Door Lock	(F14) Knob 8860-2 Levers 8860-2FL SL8860-2FL 8860-2RL	
Dormitory or Storeroom Lock	Knob 8861 Levers 8861FL SL8861FL 8861RL	
Privacy, Bedroom or Bath Lock	(F22) Knob 8862 Levers 8862FL SL8862FL 8862RL	
Bathroom Lock with Indicator	Knob 8864 Levers 8864FL 8864RL	
Bathroom Lock	Knob 8865 Levers 8865FL SL8865FL 8865RL	
Dormitory or Exit Lock	(F12) Knob 8867 Levers 8867FL SL8867FL 8867RL	
Note: Shaded area denotes rigid lever or knob.		

lockset functions

Function/Application	ANSI (Grade 1/Grade 2)	Model Number		Deadlocks
Mortise Deadlocks		D100	D200	
Cylinder x Thumbturn Deadbolt operated by key outside, thumbturn inside.	—	352		
Cylinder x Cylinder Deadbolt operated by key outside, key inside.	—	351		
Cylinder x Blank (Rose) Deadbolt operated by key outside only. No inside operation.	—	353		
Blank Plate x Thumbturn Deadbolt operated by thumbturn inside only. No outside operation.	—	354		
Cylinder x Classroom Thumbturn Deadbolt operated by key outside, deadbolt retracted by thumbturn inside. Thumbturn will not project deadbolt.	—	357		
Cylinder x Cylinder & Thumbturn Deadbolt by key outside and inside. Inside thumbturn will retract deadbolt but will not project it.	—	356		
Function/Application	ANSI (Grade 1/Grade 2)	Model Number		Deadbolts
Cylindrical Deadbolts		D100	D200	
Cylinder x Thumbturn Deadbolt operated by key outside, thumbturn inside.	E2151/E2152	D111 D112 B-D171 B-D172	D211 D212	
Cylinder x Cylinder Deadbolt operated by key outside, key inside.	E2141/E2142	D121 D122	D221 D222	
Cylinder x Blank (Rose) Deadbolt operated by key outside only. No inside operation.	E2161/E2162	D131 D132	D231 D232	
Blank Plate x Thumbturn Deadbolt operated by thumbturn inside only. No outside operation.	E2191/E2192	D141 D142	D241 D242	
Blank Plate x Cylinder Deadbolt operated by key inside only. No outside operation.	E2101/E2102	D151 D152	D251 D252	
Cylinder x Classroom Thumbturn Deadbolt operated by key outside, deadbolt retracted by thumbturn inside. Thumbturn will not project deadbolt.	E2171/E2172	D161 D162 B-D181 B-D182	D261 D262	
Occupancy Indicator x Thumbturn Deadbolt operated by thumbturn inside, emergency override key outside. Outside indicator displays "In Use" when deadbolt thrown or "Vacant" when deadbolt retracted.	N/A	N/A	D291 D292	
Deadbolt Model Number Description				
D	X	X	X	
Model Number	Grade	Function	Backset	"1" = 2-3/8", "2" = 2-3/4"



multipoint locking systems

The 7180(F)TD, 7380(F) and 7370 multi-point locks/exit devices are fully integrated - part of a complete ASSA ABLOY tornado and hurricane resistant solution with CECO StormPro® 361, CURRIES StormPro® 361 and FLEMING F-5 shutters and MckINNEY® SP hinges.

7180(F)TD three point exit devices

7180(F)TD is a robust three-point auto latching system engineered to help protect lives by security community shelter entries. Extra heavy-duty steel components firmly fasten the door to the frame - at top, bottom and center latch points - reinforcing the opening to endure severe wind speeds and flying debris.



Certifications/Compliance Fire Listing

UL-cUL Listed for use on fire doors having a rating up to and including 3-hours.

Windstorm

Certified (refer to local codes). 7180(F) TD series are UL certified for outswing doors; single door 4'0" x 8'0" and pairs 8'0" x 8'0" maximum to the following guidelines:

- Tornado and Hurricane Shelters
- FEMA 361
- ICC 500



7380(F) three-point locks

7380F series is a three-point auto deadlocking system developed to help protect lives while primarily securing a community shelter and safe room entry. Extra heavy-duty steel components firmly fasten the door to the frame - at top, bottom and center latch points - reinforcing the opening to endure severe wind speeds and flying debris.



Certifications/Compliance Fire Listing

All functions are UL-cUL Listed for use on fire doors having a rating up to and including 3-hours.

Windstorm

Certified (refer to local codes). 7380(F) series are UL certified for inswing and outswing doors; single door 4'0" x 8'0" maximum to the following guidelines:

- Tornado and Hurricane Shelters
- FEMA 320
- FEMA 361
- ICC 500



Hurricane

- ANSI/BHMA A250.13
- ASTM E330, E1886, E1996
- TAS201, TAS202, TAS203



7370 three-point locks

7370 series is a three-point auto deadlocking system developed to help protect lives while primarily securing the community shelter window openings. Extra heavy-duty steel components firmly fasten the shutter to the frame - at top, bottom and center latch points - reinforcing the opening to endure severe wind speeds and flying debris.



Certifications/Compliance

7370 series are UL certified for inswing shutters 1'8"w x 3'0"h min. to 4'0"w x 6'8"h max. to the following guidelines:

- Tornado and Hurricane Shelters
- FEMA 361
- ICC 500



Hurricane

- ICC 500
- ANSI/BHMA A250.13
- ASTM E330, E1886, E1996
- TAS201, TAS202, TAS203



exit devices

7000 series architectural exit devices

Yale® 7000 series exit devices deliver an unparalleled combination of durability, breadth of line, innovation and aesthetics. With an architecturally inspired design that features simple clean lines, both our wide and narrow stile devices are visually appealing and bring gracious totality to the entire line of *Yale* locks and hardware.

As an option, *Yale* 7000 series exit devices are available with a photoluminescent touchpad cover. *Lumi-Lite*® (top picture) allows for easy egress in an emergency blackout situation.



7100 series exit devices

A conventional exit device used for single swing doors or pairs of doors of metal, wood or composite construction.

Types

- Rim SquareBolt® Devices (type 28), Yale exclusive feature covered by patent (Patent # 5,605,362)
- Rim Pullman Bolt Devices (type 1)
- Surface Vertical Rod Devices (type 2)
- Concealed Vertical Rod Devices (types 7 and 8)
- Mortise Devices (type 3)

Features

- Certified ANSI/BHMA A156.3 Grade 1 exit hardware 
- UL-cUL listed for fire labeled or panic exit doors
- Windstorm certified (refer to local codes)  Hurricane
- Outside trim fits stock 161 door preps, escutcheon outside fitting stock 86 door preps
- Surface and concealed vertical rod devices are available in Less Bottom Rod varieties
- Double cylinder devices are available for Rim *SquareBolt*, Rim Pullman and Mortise varieties
- Available with complete range of electrified options, including REX, electric dogging, outside trim monitoring, latch pullback, bolt status monitoring or delayed egress
- Available in 14 finishes
- 5-year mechanical warranty





7200/7200M series exit devices

A narrow stile exit device compatible with the aesthetics and function requirements of contemporary doors of aluminum or metal construction.

Types

- Rim *SquareBolt* Devices (type 28), Yale exclusive feature covered by patent (Patent #5,605,362)
- Rim Pullman Bolt Devices (type 4)
- Surface Vertical Rod Devices (type 5)
- Concealed Vertical Rod Devices (types 6 and 8)

Features

- Certified ANSI/BHMA A156.3 Grade 1 exit hardware 
- UL-cUL listed for fire labeled (7200M) or panic exit doors
- Windstorm certified (refer to local codes)  Hurricane
- Optional removable mullions, keyed removable mullions, raised molding clearance kits and custom specialties are all available
- Available with complete range of electrified options, including REX, electric dogging, outside trim monitoring, latch pullback, bolt status monitoring or delayed egress
- Available in 14 finishes
- 5-year mechanical warranty





exit devices



2100 series flatbar exit devices

It's no secret that the 2100 series flatbar exit device has a reputation as the right choice for meeting the rigors of demanding industry segments.

Types

- Rim SquareBolt® Devices (type 28), Yale exclusive feature covered by patent (Patent # 5,605,362)
- Rim Pullman Bolt Devices (type 1)
- Surface Vertical Rod Devices (type 2)
- Concealed Vertical Rod Devices (types 7 and 8)

Features

- Certified ANSI/BHMA A156.3  Grade 1 exit hardware
- UL-cUL listed for fire labeled or panic exit doors
- Windstorm certified (refer to  Hurricane local codes)
- Optional removable mullions, keyed removable mullions, Torx® security screws and custom specialties are all available
- Available in 10 finishes
- 3-year mechanical warranty



1800 series flatbar exit devices

1800 series exit devices are the ideal choice for a wide variety of commercial applications where consistent quality, ease of use and installation are required.

Types

- Rim Pullman Bolt Devices (type 1)
- Surface Vertical Rod Devices (type 2)

Features

- Certified ANSI/BHMA A156.3  Grade 1 exit hardware
- UL-cUL listed for fire labeled or panic exit doors
- Outside trim fits stock 161 door preps, escutcheon outside fitting stock 86 door preps
- Available in 4 finishes
- Exit device latch head cover and end caps provided in black for all finishes
- 3-year mechanical warranty



1500 series traditional exit devices

Traditional exit devices for compliance with the exit and access demands of today's codes, where it is important to maintain the architectural lines of yester year.

Types

- Rim Pullman Bolt Devices (type 1)
- Surface Vertical Rod Devices (type 2)
- Concealed Vertical Rod Devices (type 8)
- Mortise Devices (type 3)







Features

- Certified ANSI/BHMA A156.3  Grade 1 exit hardware
- UL listed for fire labeled or panic exit doors
- Mortise devices available with fail safe or fail secure options
- Outside trim options available for most functions
- Optional removable mullions, keyed removable mullions, Torx® security screws and custom specialties are all available
- 1-year mechanical warranty





exit device functions

Series	Application	Rim Pullman Bolt	Rim SquareBolt®	Surface Vertical Rod	Concealed Vertical Rod		Mortise
					Metal Doors	Wood Doors	
7100	 Flush or Wide Stile Doors	Panic: 7100 7100-2 Fire: 7100F 7100F-2	Panic: 7150 7150-2 7150WS Fire: 7150F 7150F-2 7150FWS	Panic: 7110 7170* 7170WS Fire: 7110F 7170F* 7170WS	Panic: 7120 7160* Fire: 7120F 7160F*	Panic: 7160* Fire: 7160F*	Panic: 7130 7130-2 Fire: 7130F 7130F-2
7200	 Narrow Stile Doors	Panic: 7200	Panic: 7250	Panic: 7210	Panic: 7220	—	—
7200M	 Flush or Wide Stile Doors	Panic: 7200M Fire: 7200MF	Panic: 7250M 7250MWS Fire: 7250MF 7250MFWS	Panic: 7210M Fire: 7210MF	Panic: 7220M Fire: 7220MF	—	—
2100	 Flush or Wide Stile Doors	Panic: 2100 2100WS Fire: 2100F 2100FWS	Panic: 2150 2150WS Fire: 2150F 2150FWS	Panic: 2110 2170* Fire: 2110F 2170F*	Panic: 2120 2160* Fire: 2120F 2160F*	Panic: 2160* Fire: 2160F*	—
1800	 Flush or Wide Stile Doors	Panic: 1800 Fire: 1800F	—	Panic: 1810 Fire: 1810F	—	—	—
1500	 Flush or Wide Stile Doors	Panic: 1500 Fire: 1500F	—	Panic: 1510 Fire: 1510F	Panic: 1520 Fire: 1520F	—	Panic: 1530 Fire: 1530F

*Less Bottom Rod (LBR) option available (F90).



exit device trim

Entry functions, for doors equipped with Yale® exit devices, are provided by trim with mechanisms mortised into the doors, and exposed components in architectural finishes. *Yale* keying systems, as well as other keying, are easily integrated.

Cylinders: Brass, 6-pin, keyed-random cylinder with two keys furnished standard, 7-pin available to order. For other cylinder and keying options, see page 30.





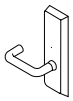





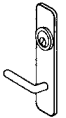



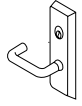



Warranty: 5-year mechanical for all 600 series trims.

 **ADA compliance** is maintained when Yale® exit devices are used with lever handle or pull trims.



Vandal-Resistant Free Wheeling lever action offers protection against forced entry, lockouts, and damage to the hardware.

Options include outside cylinder only and decorative lever handles.

Trim	Device Series	Trim Functions	Remarks
 500F Narrow Escutcheon	7200 7200M	F02, F03, F08, F09 F11, F12 Passage Blank Plate	 ADA Lever Access  Vandal-Resistant Lever Action
 510 Narrow Escutcheon With Pull	7200 7200M	F02, F03, F05, F06 F11, F12, F15, F16 Passage Blank Plate	 ADA Pull Access
 420 (Rim, V.R.) 620F (Rim, V.R.) 650F (Mortise) 350F (Mortise) Full Escutcheon	7100 2100 1800 1500	F02, F03, F08, F09, F14	 ADA Lever Access  Vandal Resistant Lever Action (Rim V.R. Only)
 630F (Rim, V.R.) 660F/670F (Mortise) Full Escutcheon	7100 2100 1500	F02, F03, F05, F06, F15 Passage Blank Plate	 ADA Pull Access
 440F 540F 580F Rose	7100 2100 1800	F02, F03, F08, F14 Passage	 ADA Lever Access  Vandal-Resistant Lever Action
 210F Plate/Finger Pull	2100	F02, F03	Baked Enamel Finishes
 603F Full Escutcheon with Thumbturn	7100 2100	F08, F09, F14 Passage	Rim, SVR, CVR for use with pull by others
 480F Narrow Escutcheon with Offset Pull	7200 7200M	F02, F03	 ADA Pull Access
 680F Full Escutcheon with Offset Pull	7100	F02, F03	 ADA Pull Access

exit device trim

trim designs

 Arcadia AR	 Augusta AU	 Carmel CR	 Jefferson JN	 Monroe MO
 Pacific Beach PB	 Pinehurst PN	 Virginia VI	 Copenhagen CO	 Litchfield LF

designer trim design

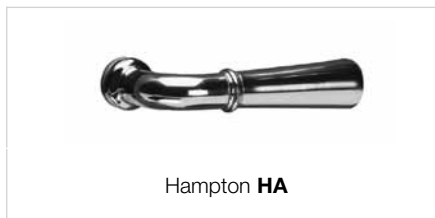

reflections® decorative levers

See page 3 for *Reflections* decorative levers.



cylinders and keying/security cylinders

cylinders and keying

All Yale® locksets are available in a wide choice of cylinder and keying options:

Cylinder Types and Options:

- Fixed Core (standard)
- Large Format Interchangeable Core
- Small Format Interchangeable Core
- Conventional Keyways
- Protected Keyways
- Security Cylinders (Not UL437 Certified)
- High Security Cylinders (UL437 Certified)

Keying Options:

- Keyed Different (KD)
- Keyed Alike (KA)
- Master-Keyed (MK)
- Grand Master-Keyed (GMK)
- Great Grand Master-Keyed (GGMK)
- Construction Keying (CMK)

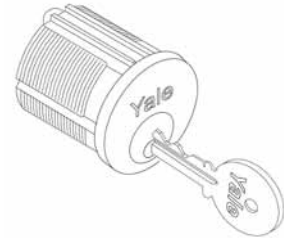

interchangeable cores

Yale® cylinders with interchangeable cores allow your master key systems to be flexible. With the special "Control" key any cylinder can have its core interchanged quickly. Any Yale core can be interchanged into any other Yale lock provided it has a interchangeable core. As a result, security for any given lock can be changed in a matter of minutes. Yale interchangeable core cylinders can be used throughout the entire master key system. They can be used selectively within the system along with Yale fixed core cylinders. There are two types of interchangeable cores that are offered by Yale.

1. Large Format (LFIC) - These cores are available in both standard Yale cylinders and also Yale® KeyMark® cylinders. Note that standard Yale cylinders and Yale KeyMark cylinders cannot be keyed to the same master key system.
2. Small Format (SFIC) - Yale offers SFIC cores in Yale KeyMark and Best® keyways A, B, C, D, E, F, G, H, J, K, L and M. Best® keyway cores can be provide keyed random, master keyed or uncombined. Yale will provide master keying to new key system only. Systems can be provided using the A2 or A4 pinning specification and can not be tied into any conventional or Yale KeyMark key systems. All cylindrical lock small format preparations and 1-3/8" housings accept either 6- or 7-pin cores.

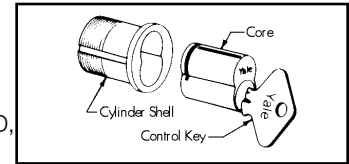

Yale® KeyMark®

For those applications requiring protected key control, Yale® KeyMark® cylinders guard against unauthorized key duplication. The Yale KeyMark Security Leg® keyway feature increases resistance against picking and impressioning and can easily retrofit into existing systems. Cylinders include mortise, rim, key-in-lever, key-in-knob, auxiliary, and interchangeable core. IC core is available in both large and small formats. All formats can be tied into one master key system.



K100

security/high security cylinders

Yale® security/high-security cylinders contain two independent locking mechanisms. The first is a traditional 6 or 7-pin tumbler mechanism with spool drivers for increased picking resistance.

The second is a 5-tumbler rotating disc mechanism with sidebar engagement. The rotating discs are spring loaded and block the bottom of the keyway. Only a specially cut key will move the discs and allow entrance of the key. This key has a special side bitting and must align all five discs perfectly before the cylinder plug will rotate to open the lock.

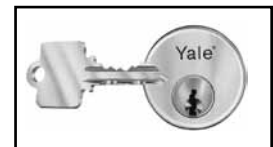

door controls

5800 series cast iron door closers

Yale® 5800 series cast iron door closers are ideal for commercial applications where ease of use, installation and aesthetics are required at an economical price.

The 5800 series features rugged construction, adjustments for backcheck, closing and latch speed, rack and pinion operation and a variety of arm options.

features

- Adjustable spring sizes 1 through 6
- Non-handed
- Cast iron
- Tri-packed: regular, parallel or top jamb mounting
- Adjustable backcheck valve
- Adjustable closing speed valve
- Adjustable latching speed valve
- Full plastic cover
- Spring power adjustment
- Hold-open and heavy-duty arms arm configurations
- Sleeve nuts included with all models
- 10-year limited warranty



compliance standards

- Certified for ANSI/BHMA A156.4 Grade 1 
- UL and cUL listed. This includes compliance to UL10C.
- Meets requirements for Americans with Disabilities Act (ADA) and ANSI/BHMA A117.1 

4400 series institutional door closers

The 4400 series offers customers the ideal combination of superior performance, quality and strength.

features



- Adjustable spring sizes 1 through 6
- Tri-pack standard (regular arm, top jamb and parallel arm mounting)
- Non-handed
- Standard, separate and independent, latch, sweep and backcheck intensity valves
- 2-3/16" (56mm) projection
- Staked valves
- All standard arm applications allow doors to swing 180°, conditions permitting
- 25-year limited warranty



optional features

- Metal cover
- Corrosion-resistant model (specify 4400S)
- Delayed action
- Enhanced backcheck
- Heavy-duty arms available: Regular Rigid, Parallel Rigid, Holder/Stop, Holder/Stop Spring and UNI Stop™
- Slide track – push or pull mounting

compliance standards

- Certified ANSI/BHMA A156.4, Grade 1 
- UL-cUL listed
- UL10C compliant for positive pressure
- ADA compliant (4400 Series) 



door controls

3000 series architectural door closers

The 3000 series offers the perfect combination of reliability, appearance and durability in today's market.

features



- Adjustable spring sizes 1 through 6
- Tri-pack standard (regular arm, top jamb or parallel arm mounting)
- Non-handed
- Staked valves
- Standard, separate and independent, latch, sweep and backcheck intensity valves
- 2-1/8" (54mm) projection (standard covers)
- All standard arm applications allow doors to swing 180°, conditions permitting
- 25-year limited warranty



optional features

- Metal, architectural plastic or architectural metal covers
- Delayed action
- Heavy-duty arms available: Parallel Rigid, Holder/Stop, Holder/Stop Spring and UNI Stop™

compliance standards

- Certified ANSI/BHMA A156.4, Grade 1 
- UL-cUL listed
- UL10C compliant for positive pressure
- ADA compliant (3301 and 3501) 

2700 series architectural door closers



The 2700 series features rugged construction, adjustments for backcheck, closing and latch speed, and rack and pinion operation.

features

- Adjustable spring sizes 1 through 6
- Non-handed
- Aluminum
- Tri-packed: regular, parallel or top jamb mounting
- Adjustable backcheck valve
- Adjustable closing speed valve
- Adjustable latching speed valve
- Full plastic cover
- Spring power adjustment - adjust with adjustable wrench
- Hold-open and heavy-duty arms available
- Standard fasteners: (included with tri-packed, NHO only)
 - Self-drilling screws (6), Cover screws (2), Slide arm screws (2), Machine screws (6), Pinion screw (1), Allen wrench (1)
- Optional fasteners:
 - Sleeve nuts, Through-bolts and grommet nuts
- 10-year limited warranty



compliance standards

- Certified ANSI/BHMA A156.4, Grade 1 
- UL-cUL listed
- UL10C compliant for positive pressure
- Designed to meet requirements for ANSI/BHMA A156.4 Grade 1. Door closers meet handicapped requirements for interior doors. 



door controls

51 series industrial door closers

The 51 series is ideal for use with aluminum store front doors and frames, yet they also complement wood or metal door installations.



features

- Non-handed
- Staked valves
- Standard, separate and independent, latch, sweep and backcheck intensity valves
- 2-7/8" (73mm) projection
- 15-year limited warranty

optional features

- Delayed action (in lieu of backcheck)
- Molded plastic cover

compliance standards

- Certified ANSI/BHMA A156.4, Grade 1 
- UL-cUL listed
- UL10C compliant for positive pressure
- ADA compliant (51BF) 



	51	51BF
Adjustable spring sizes 3 through 6	X	
Adjustable spring sizes 1 through 4		X
Tri-pack standard (regular arm, top jamb or parallel arm mounting)	X	X

1100 series industrial door closers

The 1100 series features rugged construction, adjustments for closing and latch speed, and rack and pinion operation.

features

- 1101BF (non-hold open) and 1111BF (hold open) door closers are adjustable spring sizes 1 through 4
- 1104BC (non-hold open) door closers are spring size 4
- Non-handed
- Full rack and pinion
- Aluminum
- Tri-packed: regular, parallel or top jamb mounting
- Adjustable backcheck valve
- Adjustable closing speed and latching speed valves
- Auxiliary door stop required
- Sleeve nuts included with all models
- 5-year limited warranty

optional features

- Cover (order separately)



compliance standards

- UL-cUL listed
- 1101BF/1111BF - designed to meet requirements for ANSI/BHMA A156.4 Grade 1. Door closers meet handicapped requirements for light to medium weight interior doors. 
- 1104BC - designed to meet requirements for ANSI/BHMA A156.4 Grade 2



electrified products

securex®

In 2001, Yale revolutionized the exit device market with its introduction of SecureX®, a delayed egress exit device. As a result of outstanding customer response and loyalty, Yale is proud to expand the *SecureX* name to include its entire line of electromechanical hardware.

Throughout the industry, the *SecureX* name is synonymous with security, strength, quality and durability. The 7100D series exit devices have evolved as premier products for retail, healthcare and assisted living applications, offering the ideal combination of security and life safety.

The expansion of the *SecureX* name is yet another example of the Yale ongoing commitment to meeting the needs of its customers. Under the *Yale SecureX* brand name, Yale customers can expect a range of new and exciting electromechanical products to meet a variety of applications, ensuring a distinct “Yale Advantage.”

The *Yale SecureX* brand will include inTouch® standalone touchscreen access, alarms and alarmed devices, and electrified mortise and cylindrical locking products.

SecureX products incorporate the highest level of security available with the added flexibility and security of remote electrical control. Electrified hardware is ideal for interfacing with access control, security and fire alarm systems.

electrolynx®



What normally took an hour or more to connect now takes minutes. All Yale® electrified hardware is equipped with ElectroLynx® connectors. As a standard feature, these connectors link power from the incoming source to electrified locking products, including hinges, locks, exit devices, magnetic holders and strikes.

Note: Electrified door hardware with ElectroLynx® connectors require a compatible hinge.

mortise locksets

- Certified ANSI/BHMA A156.13 Series 1000, Grade 1
- UL10B Listed for 3-hour fire-rated openings
- Utilizes 8800 lockset
- Continuous duty integral solenoid
- Available in 12 or 24VDC

- Fail Safe or Fail Secure Operation
- Request to Exit (REX), Latchbolt Monitoring (LBM), Deadbolt Monitoring (DBM) , Integrated Total Security (ITS) options available



cylindrical locksets

- Certified ANSI/BHMA A156.2 Series 4000, Grade 1 and 2
- UL Listed
- Utilizes 5400LN, 5300LN or 4700LN lockset
- Free Wheeling lever mechanism
- Available in 12 or 24V

- External rectifier accepts AC or DC voltage
- Mechanical cylinder override
- Fail Safe or Fail Secure Operation
- Request to Exit (REX) option available (5400LN series only)

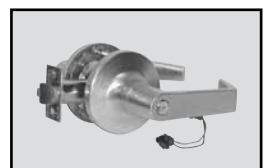

electrified products

mortise and cylindrical functions

Fail Safe – Locked when power is on and unlocked when power is off.

Function Description	Mortise Model Number	Cylindrical Model Numbers
<ul style="list-style-type: none"> Power on – outside lever locked Inside lever always free No key override 	8880	4780LN 5380LN 5480LN
<ul style="list-style-type: none"> Power on – both levers locked No key override 	8884	N/A
<ul style="list-style-type: none"> Power on – outside lever locked Mechanical key override by outside 	8890	4790LN 5390LN 5490LN
<ul style="list-style-type: none"> Power on – both levers locked Mechanical key override by both sides 	8894-2	N/A
<ul style="list-style-type: none"> Power on – outside lever locked Deadbolt by key outside, thumbturn inside Mechanical key override by outside 	8896	N/A
<ul style="list-style-type: none"> Power on – outside lever locked Deadbolt by key both sides Mechanical key override by both sides 	8896-2	N/A
<ul style="list-style-type: none"> Power on – both levers locked Deadbolt by key outside, thumbturn inside Mechanical key override by outside 	8898	N/A
<ul style="list-style-type: none"> Power on – both levers locked Deadbolt by key both sides Mechanical key override by both sides 	8898-2	N/A

Fail Secure – Unlocked when power is on and locked when power is off.

Function Description	Mortise Model Number	Cylindrical Model Numbers
<ul style="list-style-type: none"> Power off – outside lever locked Inside lever always free No key override 	8881	4781LN 5381LN 5481LN
<ul style="list-style-type: none"> Power off – both levers locked No key override 	8885	N/A
<ul style="list-style-type: none"> Power off – outside lever locked Mechanical key override by outside 	8891	4791LN 5391LN 5491LN
<ul style="list-style-type: none"> Power off – both levers locked Mechanical key override by both sides 	8895-2	N/A
<ul style="list-style-type: none"> Power off – outside lever locked Deadbolt by key outside, thumbturn inside Mechanical key override by outside 	8897	N/A
<ul style="list-style-type: none"> Power off – outside lever locked Deadbolt by key both sides Mechanical key override by both sides 	8897-2	N/A
<ul style="list-style-type: none"> Power off – both levers locked Deadbolt by key outside, thumbturn inside Mechanical key override by outside 	8899	N/A
<ul style="list-style-type: none"> Power off – both levers locked Deadbolt by key both sides Mechanical key override by both sides 	8899-2	N/A



electrified products

exit devices

The Yale® 7000 series exit device offers a complete range of electrical options:

- Latch Retraction
- Electric Dogging
- Mortise Device Trim Control
- Touchbar Monitor or Signaling
- Outside Trim Monitor or Signaling
- Bolt Position Monitor or Signaling
- Delayed Egress (Patent No. 7,469,942)
- Electric Trim Control
- Alarm



Continuity in appearance, security and functions with the 7000 series mechanical exit device is maintained. Electrified exit devices may be integrated into the monitoring security and alarm systems of most buildings.

exit device option descriptions

A	Alarm Option	P	Latch Retraction
B	Touchbar Monitor	S	Bolt Monitor
D	Delayed Egress	SAFE	Fail Safe Operation (Mortise)
G	Electric Dogging	SECURE	Fail Secure Operation (Mortise)
H*	Security Package (DPS)	690F	Fail Safe Electrified Trim
O	Trim Monitor	691F	Fail Secure Electrified Trim

Note: Any combination of the following options cannot be ordered together:
1) P, G, or D 2) B or A 3) D, B or A
***Only available for rim and SquareBolt® Devices when used with Delayed Egress option.**

electrified options chart

Model #	Exit Device Description	A	B	D	G	H	O	P	S	SAFE	SECURE	690F	691F
7100(F)	Rim Exit Device (Wide)	x	x	x	x	x	x	x	x			x	x
7110(F)	Surface Vertical Rod (Wide)	x	x	x	x		x	x	x			x	x
7120(F)	Concealed Vertical Rod (Wide)	x	x	x	x		x	x	x			x	x
7130(F)	Mortise Exit Device (Wide)	x	x	x	x		x	x	x	x	x		
7150(F)	Rim SquareBolt® Device (Wide)	x	x	x	x	x	x	x	x			x	x
7160(F)	Concealed Vertical Rod (Wide)	x	x	x	x		x	x	x			x	x
7170(F)	Surface Vertical Rod (Wide)	x	x	x	x		x	x	x			x	x
7200(M)(F)	Rim Exit Device (Narrow)	x	x	x	x			x	x				
7210(M)(F)	Surface Vertical Rod (Narrow)	x	x	x	x			x	x				
7220(M)(F)	Concealed Vertical Rod (Narrow)	x	x	x	x			x	x				
7250(M)(F)	Rim SquareBolt® Device (Narrow)	x	x	x	x			x	x				

stand-alone door alarm

The SDA16 stand-alone battery operated door alarm is designed to continually monitor the status of a door. When the door is opened without authorization, an alarm is triggered to alert the security violation. This alarm features a Peizo horn which blasts a deafening 105+ decibels to alert the violation.



This unit is ideal for emergency doors as well as stairwell doors and rear exit doors in retail environments. The unit, which can also be hardwired, easily complements existing hardware, making any opening alarmed. The SDA16 door alarm is typically mounted on the interior of the door frame or door and is paired with a magnet mounted on the opposing side of the door gap.

remote mounting

The SDA16 can be installed remotely from the door by attaching the contacts to the door and frame. The unit can be installed up to 6 feet from the door. This provides the ideal solution for circumstances where exposure to weather may be an issue. To order specify "SDA16XL".

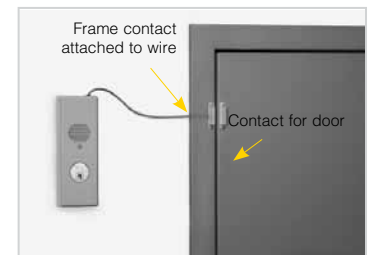

Note: Actual wire length is 6 feet.



electrified products

inTouch® stand-alone touchscreen locks

Yale® inTouch® stand-alone touchscreen access lock combines robust cylindrical locksets with a contemporary electronic aesthetic.

Users benefit from an interactive touchscreen that makes day-to-day access effortless and offers voice-guided programming for simple updates to user information in the event of staffing changes or security breaches.

Ideal for a wide variety of applications, *inTouch* is recommended for management offices, patient records storage, storerooms, staff lounges, restroom doors, etc. Anywhere that requires simple controlled access is an ideal place for *inTouch*!

inTouch is engineered for quick & easy installation and fits into the standard ANSI/BHMA A156.115 cylindrical locks with lever door prep with only one additional 3/4" hole and 7 screws including latchbolt and strike.

features

Electronic Elements

- Stand-alone touchscreen access locking device
- Menu access to voice guided programming available through touchscreen
- Pre-programmed voice options: English (default), Spanish or French
- 4 AA alkaline batteries
- Visual and tone playback confirmation provides positive reassurance while operating
- Silent mode - available to disable tone playback for use in quiet areas
- Passage mode - allows continuous entry for non-restricted traffic
- Lockout mode - restricts user PIN code access
- Auto re-lock - default of 5 seconds. Adjustable in Advanced operating mode
- Optional hardwire input for 9VDC external power
- Remote unlock available for allowing access through switch

Mechanical Components

- Certified ANSI/BHMA A156.2, Grade 1 
- UL-cUL listed for use on fire doors
- ADA compliant levers
- Install lock, latchbolt and strike with only 7 screws
- Optional cylinder/key override – full range of Yale® 6-pin conventional, protected and security cylinders available including large and small format interchangeable core
- ANSI/BHMA A156.115 cylindrical lock with lever door prep with one additional 3/4" hole
- Weather resistant
- 3-year limited warranty

functions

Model Number	Function Description
E4760LN	Without Cylinder Override
E4761LN	With Cylinder Override



trim



		
Augusta AU	Monroe MO	Pacific Beach PB



Touchscreen as shown when not activated



Touchscreen as shown when activated



electrified products

Affinity® multi-family access locks

Yale® Affinity® (RFID) Smart Card Locks combine the latest Radio Frequency Identification technology with a flexible electronic locking system, perfect for Multi-Family, Apartment or Condominium Housing. Designed with ease of use and resident security in mind, Yale brings contactless identification electronic locking to the multi-family housing market.

Combined with VISION by VingCard® software, Affinity is a full-featured, functionally rich access control system with the power, flexibility and ease of use to meet the operating needs of any multi-family property both now and in the future.



features

Electronic Elements

- Stand alone electronic lock with smart RFID technology
- Future re-programmable FLASH RAM lock memory
- 600 event audit trail
- VISION by VingCard® System Software
- FCC approved

Mechanical Components

- UL listed for use on fire doors
- ADA compliant
- High security mortise lockcase
- Solid brass handle with self lubricating long life bearings
- 3-point steel antifriction latch construction
- Full 1-inch throw case hardened deadbolt
- 3AA batteries – provide up to 3 years normal life time
- Simultaneous Retraction – the deadbolt and latch are automatically retracted by inside handle for easy egress in emergency situations
- Optional Passage Mode – allows Affinity to be put in passage for free access without the use of the keycard when desired
- Optional Key Override – full range of Yale® conventional, protected, and security cylinders available



functions

Model Number	Function Description
VCAF52	Without Cylinder Override
VCAF53	With Cylinder Override

trim



VAU	VAR	VGH	VMO

electrified products

Symphony® integrated weigand solutions

Symphony locks and exit device trims combine a card reader, door position switch (DPS), and request-to-exit (REX) signaling in a sleek, pleasing design backed by Yale® Grade 1 hardware. *Symphony* is available in 8800 mortise locks, 5400LN cylindrical lock and a variety of 7000 series exit devices (rim, mortise and vertical rod). *Symphony* offers lever trim with similar designs and finishes for the three types of locks to create a continuity of design.

Symphony products are easily integrated into a Wiegand-compatible access control system. It is available with 125 kHz HID proximity reader technology or 13.56 MHz HID iCLASS® reader technology. All *Symphony* products offer solenoid (fail safe or fail secure) operation.

features

- Standard Wiegand Interface
- Easily integrates with access control systems
- Complete monitoring of the opening
- Secure door position monitoring (ensures latchbolt is extended when door is closed)
 - Mortise locks - internal switch
 - Cylindrical locks and exit devices - external switch provided
- Request to exit
- Secure-side electronics
- Available with proximity readers to accept either HID 125 kHz (26-39 bit) or iCLASS® 13.56 MHz (2K-32K) formats
- Available with a broad range of lever designs
- Cost effective, expandable platform
- Incorporates mechanical door hardware into existing access control platforms

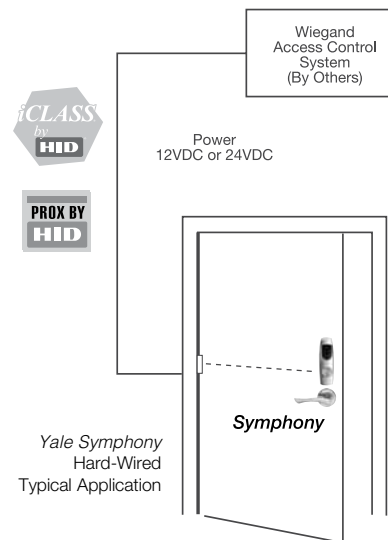
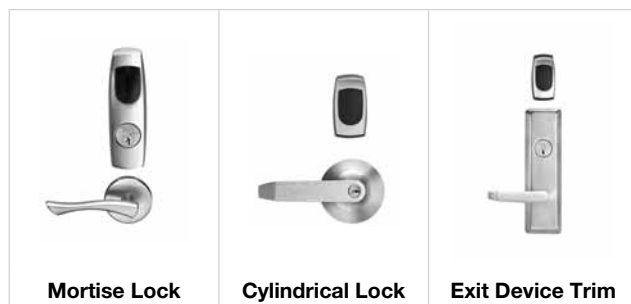

Symphony® is ideal for

- Government Facilities
- Universities
- Corporate Complexes
- Healthcare Facilities

software

- Third party access control system and software (by others)
- Accepts all HID 125 kHz (26-39 bit) or iCLASS® 13.56 MHz (2K-32K) proximity formats

operating power

- Mortise lock: 12VDC or 24VDC solenoid operated, available as Fail Safe or Fail Secure
- Cylindrical lock: 12VDC or 24VDC solenoid operated, available as Fail Safe or Fail Secure
- Exit devices: 24VDC solenoid operated, available as Fail Safe or Fail Secure
- 125 kHz reader: requires 12VDC
- 13.56 MHz iCLASS® reader: will operate with either 12VDC or 24VDC



Yale Real Living™

With an easy-to-use acrylic touchscreen or durable push button keypad, the Yale Real Living™ deadbolt brings wireless access to residential home security. Available with either Z-Wave® or Zigbee®, Yale Real Living integrates seamlessly into a wide range of home control and security systems, making everyday living easier and safer.

- Available in both durable acrylic touchscreen or simple, elegant, tamper-resistant keypad
- Illuminated touchscreen and keypad for convenient night time access
- Touchscreen – Tri-lingual in English, Spanish, French
- For use on all standard non-fire rated interior and exterior doors
- Motorized tapered bolt helps align door during locking
- Available in stand-alone, Z-Wave, or ZigBee configurations
- Users:
 - 25 Users stand-alone without wireless
 - 250 Users with wireless
- Warranty – 3-year mechanical and 1-year electronics and finish when used in commercial, institutional or industrial applications

finishes

ANSI/BHMA Code	Finish Description	US Code
605	Polished Brass	US3
613e	Oil Rubbed Bronze Permanent	US10BP
619	Satin Nickel Plated, Clear Coated	US15

designs



Touchscreen Exterior



Push Button Exterior



Interior Escutcheon

residential

Design Elements™

Sustaining the legacy of high standards set forth by Linus Yale in the mid-19th century, Design Elements™ from Yale® artfully designed and finely crafted locksets remain unmatched in the industry today. Made of solid brass and crafted with fine detail, *Design Elements* sets the industry standard for exceptional beauty teamed with high performance.



- Solid brass composition
- Available in 4 distinctive finishes
- Simple install in 3 easy steps
- Available KW-1 or SC-1 keyway
- Push-button locking – keyed entry
Push-pin locking – privacy function
- Solid brass key cylinder and housing
- Spring loaded rosettes – ensure knob/levers spring back to original position
- Warranty – 3-year mechanical and 1-year finish when used in commercial, institutional or industrial applications

finishes

ANSI/ BHMA Code	Finish Description	US Code
605e	Bright Brass, PVD	US3PVD
613e	Dark Oxidized Satin Bronze, Permanent	US10BP
619	Satin Nickel Plated, Clear Coated	US15
625	Bright Chrome Plated	US26

All Design Elements™ offering available in these finishes.

knob designs

Demi Round (DMR)	Ellipse (ELP)	Ellipse Keyed Entry Rose as shown	Ellipse Optional rose styles		
			Ovalette	Rondel	Medallion

lever designs

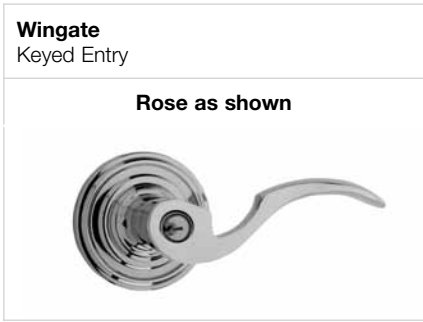
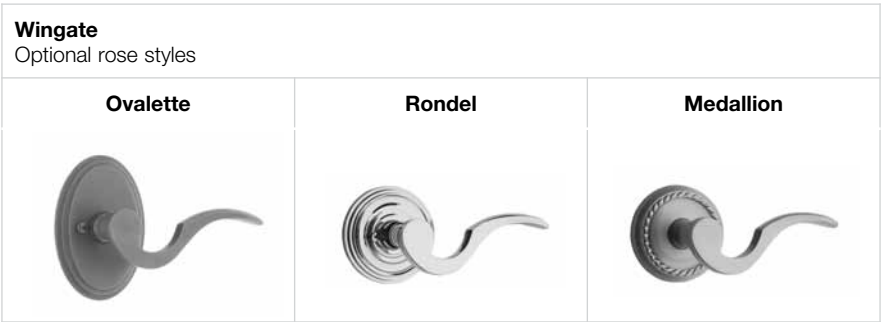

deadbolt designs

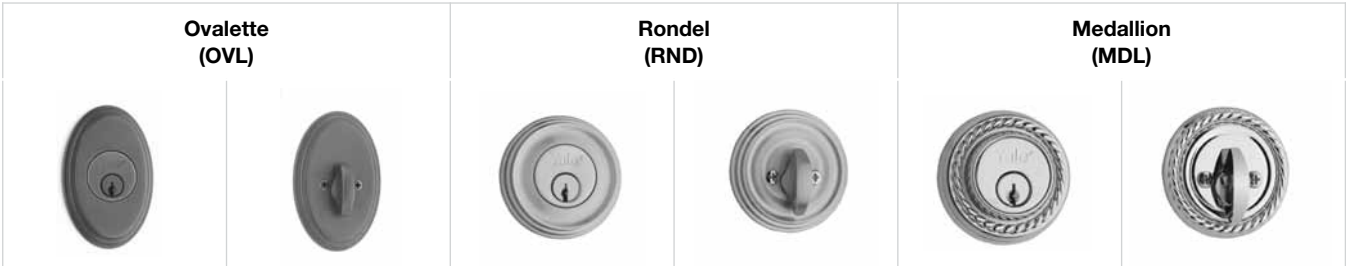

interconnected/non-interconnected handleset designs



*Note: Interconnected or Non-Interconnected option is available on 1 Piece Handlesets

residential

YH Collection™

The YH Collection™ from Yale® continues a legacy of distinctive design, high manufacturing standards and demanding performance started by Linus Yale in the mid-19th century. The *YH Collection* leverages years of engineering refinement with artful execution to offer a series of ANSI/BHMA Grade 2 superior light commercial quality locks that will beautifully serve facilities for generations. They offer superior functionality such as push-button locking, removable trim for simple re-keying, and a lifetime limited finish and mechanical warranty.



- ANSI/BHMA Certified Grade 2 
- Available in 11 distinctive finishes
- Easy install mounting system – square spindle simplifies installation - knobs, levers
- Pre-installed mounting screws
- Concealed mounting screws – clean upgraded look
- Available KW-1, SC-1 keyway
E1R (Para) keyway available for deadbolts and levers only
- Push button locking – panic-free egress
- Solid brass key cylinder and housing
- Removable lever/knob and rosettes – allows for easy scratch-free installation
- Front removable deadbolt cylinder – premier series
- Heavy-duty shroud – added anti-pry security
- Four-wound spring chassis – heavy-duty feel, eliminates lever sag
- Warranty - 3-year mechanical and 1-year finish when used in commercial, institutional or industrial applications

finishes

ANSI/ BHMA Code	Finish Description	US Code
605	Bright Brass	US3
609	Satin Brass, Blackened, Satin Relieved, Clear Coated	US5
613	Dark Oxidized Satin Bronze, Oil Rubbed	US10B
613e	Dark Oxidized Satin Bronze, Permanent	US10BP
619	Satin Nickel Plated, Clear Coated	US15
620	Satin Nickel Plated, Blackened, Satin Relieved, Clear Coated	US15A
625	Bright Chrome Plated	US26
626	Satin Chrome Plated	US26D

Finish Code	Description
GM	Gun Metal
TB	Textured Black
YGG	Yale Guard™ Gold

product finish availability*

YH Collection™		YGG	605 (US3)	609 (US5)	613 (US10B)	613e (US10BP)	619 (US15)	620 (US15A)	625 (US26)	626 (US26D)	GM	TB
Knobs	Bridgeport	•	•	•	•		•	•	•	•	•	•
	Cambridge	•	•	•	•	•	•	•	•	•	•	•
	Dartmouth		•		•	•	•	•	•	•	•	
	Oxford	•	•	•		•	•	•	•	•		•
	Stratford	•	•	•					•	•		
Levers	Academy	•	•	•			•	•	•	•		•
	Cascade	•	•	•			•	•	•	•	•	
	Citadel	•	•	•	•	•	•	•	•	•		
	Marina		•			•	•		•	•	•	
	McClure	•	•	•		•	•	•	•	•		
	Meridian	•	•	•			•	•	•	•	•	•
	Milan	•	•	•			•	•	•	•	•	•
	Norwood	•	•	•	•	•	•	•	•	•	•	•
Nottingham	•	•	•			•	•	•	•			
Deadbolts	Premier Single Cyl	•	•	•		•	•	•	•	•	•	
	Premier Double Cyl	•	•	•			•	•	•	•		
	Select Single Cyl	•	•	•	•	•	•	•	•	•	•	•
	Select Double Cyl	•	•	•	•	•	•	•	•	•	•	•
Handlesets	Fairfield	•				•	•	•		•	•	
	Homestead	•		•		•	•	•	•	•	•	•
	Jamestown	•		•	•	•	•	•	•	•	•	•
	Victoria ¹		PVD			•	•	•		•	•	
Rosette Finishes	Oval		•	•		•	•	•	•	•	•	•
	Traditional		•	•		•	•	•	•	•	•	•

*Check current Yale Residential Price Book for complete listing of product function and the availability in each finish listed above.

¹Victoria available in 605 (US3) with PVD coating, specify 605e.

knob designs



optional rosettes for knobs and levers

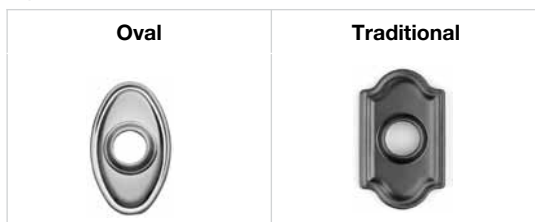

lever designs



deadbolt designs



handleset designs

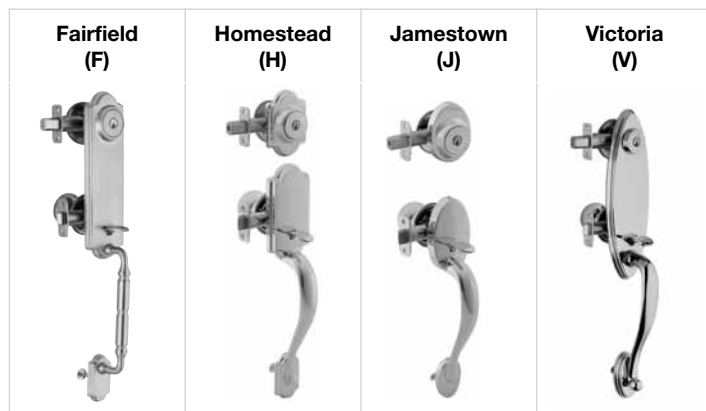

interconnected designs

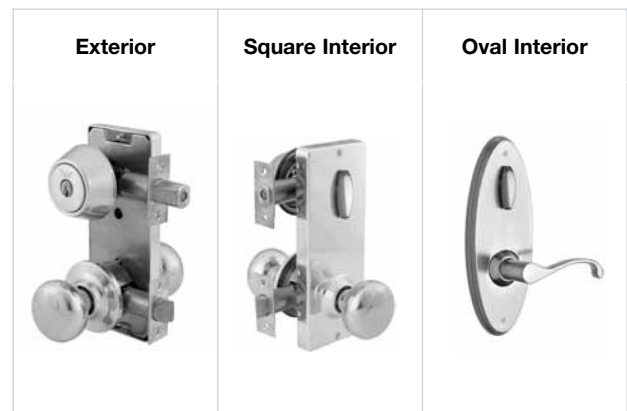



residential

New Traditions®

New Traditions® from Yale® offers outstanding strength, durability and simple, elegant designs highlighted by natural curves for comfort and ease of turning. All *New Traditions* products are built on a steel ANSI/BHMA Grade 3 chassis and feature concealed holding screws and solid brass cylinder assemblies. In addition, all *New Traditions* products feature Quick-Install™, a unique chassis design, which drastically reduces installation time.

Note: *New Traditions* are not for use with commercial hollow metal doors.

- ANSI/BHMA Certified Grade 3 
- Available in 10 distinctive finishes
- Quick install mounting system – knobs
- Pre-installed mounting screws – knobs
- Concealed mounting screws – clean upgraded look
- Available KW-1, SC-1 keyway
E1R (Para) keyway available for deadbolts and levers only
- Solid brass key cylinder
- Removable lever/knob and rosettes – allows for easy scratch-free installation
- Warranty – 3-year mechanical and 1-year finish when used in commercial, institutional or industrial applications



finishes

ANSI/ BHMA Code	Finish Description	US Code
605	Bright Brass	US3
609	Satin Brass, Blackened, Satin Relieved, Clear Coated	US5
613	Dark Oxidized Satin Bronze, Oil Rubbed	US10B
613e	Dark Oxidized Satin Bronze, Permanent	US10BP
619	Satin Nickel Plated, Clear Coated	US15
620	Satin Nickel Plated, Blackened, Satin Relieved, Clear Coated	US15A
625	Bright Chrome Plated	US26
626	Satin Chrome Plated	US26D

Finish Code	Description
GM	Gun Metal
TB	Textured Black

product finish availability*

New Traditions®		605 (US3)	609 (US5)	613 (US10B)	613e (US10BP)	619 (US15)	620 (US15A)	625 (US26)	626 (US26D)	GM	TB
Knobs	Cirrus	•	•	•	•	•	•	•	•	•	•
	Horizon	•	•	•	•	•	•	•	•	•	•
	Terra	•			•	•	•	•	•	•	
	Valley	•	•					•	•		
Levers	Mesa	•	•	•	•	•	•	•	•		
	Prairie	•	•			•	•	•	•		
	Savannah	•	•	•	•	•	•	•	•	•	•
	Woodland	•	•	•	•	•	•	•	•	•	•
Deadbolts	810 Dummy	•	•		•	•	•	•	•		
	820 Single Cyl	•	•	•	•	•	•	•	•	•	•
	840 Double Cyl	•	•	•	•	•	•	•	•	•	•
	880 One Way	•	•	•	•	•	•	•	•	•	•
	860 One Sided w/plate	•	•	•	•	•	•	•	•		
Handlesets	El Dorado	•	•				•	•	•		
	McKinley	•	•	•	•	•	•	•	•	•	•
	Teton	•	•		•	•	•	•	•	•	•
	Rainier	•			•	•	•	•	•	•	•

* Check current Yale Residential Price Book for complete listing of product function and the availability in each finish listed above.

knob designs

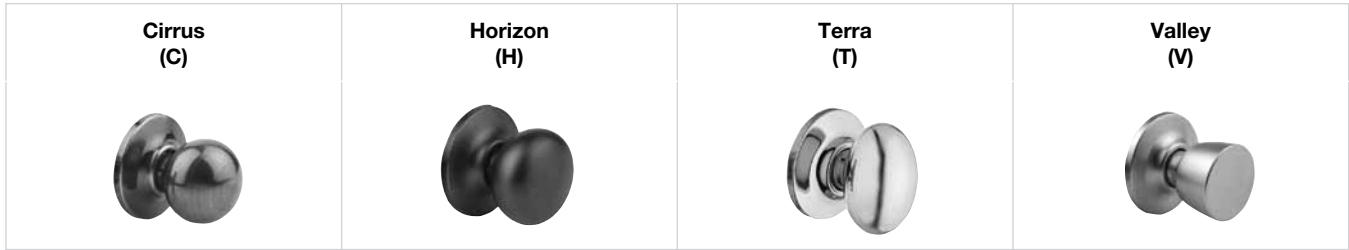

lever designs

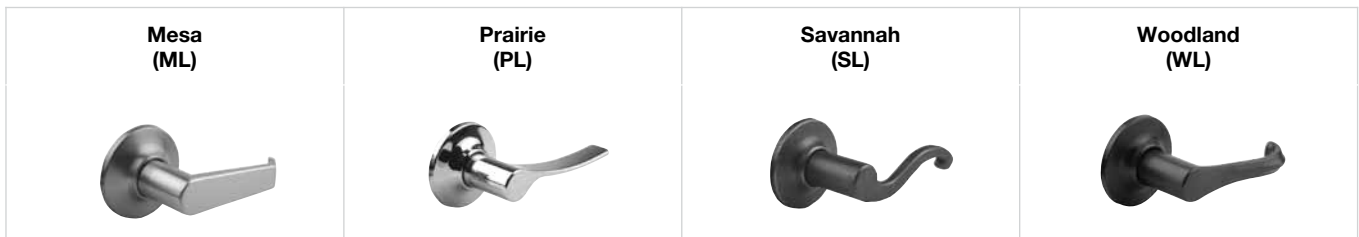

deadbolt designs



handleset designs

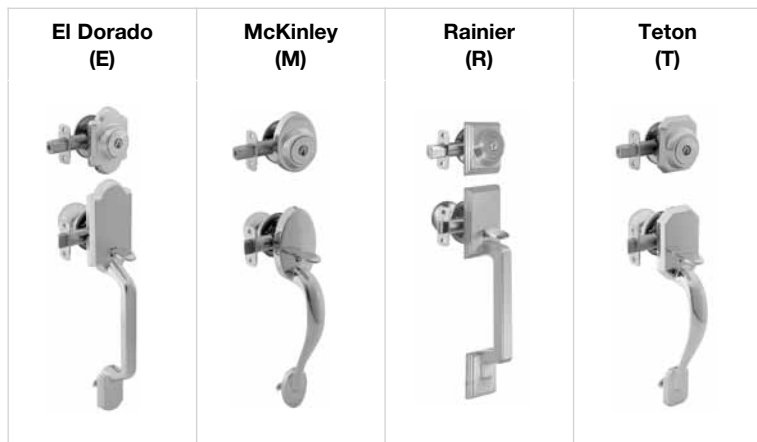



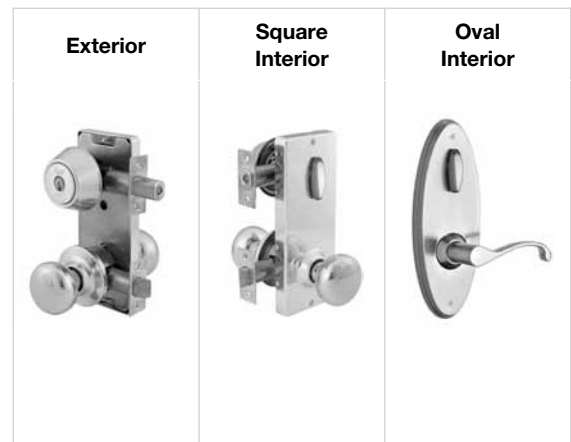

interconnected designs



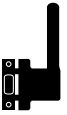

residential functions

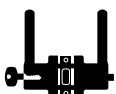
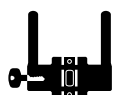
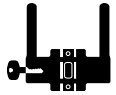
Function/Application	Sample Illustration	design ELEMENTS™		YH COLLECTION™		NEW TRADITIONS®	
		Lever	Knob	Lever	Knob	Lever	Knob
Locksets							
Dummy		81	80	81	80	81	80
Passage		11	10	11	10	101	100
One Sided w/Plate		N/A	N/A	61	60	161	160
Privacy		21	20	21	20	201	200
Bathroom		N/A	N/A	22	26	221	226
Entry		71	70	71 (Lever/Lever) 72 (Knob/Lever)	70	771 (Lever/Lever) 701 (Knob/Lever)	700
Classroom		N/A	N/A	76	75	N/A	N/A
Storeroom		N/A	N/A	79	78	N/A	780



residential functions

Function/Application	Sample Illustration	design ELEMENTS™		YH COLLECTION™		NEW TRADITIONS™	
		Lever	Knob	Lever	Knob	Lever	Knob
Locksets - Interconnected							
Single Locking		N/A	N/A	851	850	851	850
Double Locking		N/A	N/A	871	870	871	870
Handlesets - Interconnected (Interior pack – style and handing must be specified.)							
Single Locking		650	650	651	650	651	650
Handlesets - Non-Interconnected (Interior pack – style and handing must be specified.)							
Dummy		98	98	983 984 986 987	983 (V) 984 (F) 986 (H) 987 (J)	581 681 682 683	581 (E) 681 (T) 682 (M) 683 (R)
Single Cylinder		926	926	923 924 926 927	923 (V) 924 (F) 926 (H) 927 (J)	521 621 622 623	521 (E) 621 (T) 622 (M) 623 (R)
Double Cylinder		N/A	N/A	944 946 947	944 (F) 946 (H) 947 (J)	541 641 642 643	541 (E) 641 (T) 642 (M) 643 (R)
Deadbolts							
Dummy		N/A	N/A	N/A	N/A	810	
Single Cylinder		82		82 Premier 83 Select		820	
Double Cylinder		N/A		84 Premier 85 Select		840	
One Sided w/Plate		N/A		87 Select		860	
One Way		N/A		N/A		880	



notes



notes



online literature and templates

For the latest information on Yale Locks & Hardware products, visit our website at: www.yalelocks.com

Click on the "Product Information" button to find:

- Catalogs
- Parts manuals
- Templates
- Specifications
- Installation instructions

Yale® customers can click on the ebusiness symbol  on the website to register for an ebusiness account to:

- Check the status of orders
- Check availability of QuickShip items
- Track your order and confirm delivery
- Receive email notification of template changes
- And More...

Or contact us at:

U.S.A.

Yale Locks & Hardware

Address: 225 Episcopal Road, Berlin, CT 06037-4004
Tel: 1-800-438-1951 • Fax: 1-800-338-0965 • www.yalelocks.com

Canada:

ASSA ABLOY Door Security Solutions Canada

Address: 160 Four Valley Drive, Vaughan, Ontario L4K 4T9
Tel: 1-800-461-3007 • Fax: 1-800-461-8989 • www.assaabloy.ca

International:

ASSA ABLOY Americas International

Tel: 1-905-821-7775 • Fax: 1-905-821-1429 • www.assaabloyai.com

Yale Locks & Hardware is a division of Yale Security Inc., an ASSA ABLOY Group company.

Yale®, SecureX®, PowerTrack®, Reflections®, ElectroLynx®, Lumi-Lite®, SquareBolt®, New Traditions®, Symphony®, Affinity®, inTouch® and MicroShield® are registered trademarks of Yale Security Inc., an ASSA ABLOY Group company. Yale Real Living™, Design Elements™, YH Collection™ and Uni Stop™ are trademarks of Yale Security Inc., an ASSA ABLOY Group company. Other products' brand names may be trademarks or registered trademarks of their respective owners and are mentioned for reference purposes only. These materials are protected under U.S. copyright laws. All contents current at time of publication. Yale Security Inc. reserves the right to change availability of any item in this catalog, its design, construction, and/or its materials. Copyright © 1999, 2012, Yale Security Inc., an ASSA ABLOY Group company. All rights reserved. Reproduction in whole or in part without the express written permission of Yale Security Inc., an ASSA ABLOY Group company is prohibited.

YALE, with its unique global reach and range of products, is the world's favorite lock.

ASSA ABLOY is the global leader in door opening solutions, dedicated to satisfying end-user needs for security, safety and convenience.

42027-11/12RE