



SCHLAGE

HL Series

Quiet hospital push/pull hardware



The Schlage® HL Series hospital push/pull hardware

The HL Series includes a full line of push/pull hardware that is ideal for healthcare and other institutional applications where ease of operation is needed – even when hands are not free.

Delivering both superior quality and exceptional performance, the HL Series offers a wide variety of popular finishes and configurations providing the flexibility needed to meet the most demanding door control applications.

Quiet functionality

Hospitals and other healthcare environments have special requirements for noise reduction to help patients heal faster and staff perform more accurately and efficiently.

There are many sources of noise, but choosing quiet door hardware can help reduce excess noise and create quieter environments. The newly redesigned HL Series quiet hospital push/pull hardware offers a proven 50% quieter paddle operation than our previous product, providing healthcare organizations a reliable solution for noise reduction initiatives.

- Dampened paddle action – depression and snap back – reduces noise associated with hardware operation
- Proven 50% quieter paddle operation – both in the pull and push direction – than our previous solution
- Comes standard on all HL Series hardware

Applications

Anywhere operational noise is disruptive:

- Healthcare areas where patients are sleeping and healing
- Work spaces where concentration is important
- Busy traffic areas such as hallways
- Chapels or auditoriums where noise can be disturbing
- Office or administrative areas



Tubular (bored) push/pull hardware

HL6

Tubular push/pull hardware

The HL6 push/pull hardware is a durable and versatile tubular latching solution for commercial and institutional settings. The traditional design has a short throw angle, allowing the door to be opened with an easy push or pull action, even when hands are not free.



Features and benefits

- Quiet functionality
- Passage function
- Six mounting positions
- 10 finishes, including antimicrobial options
- Six available options, including engraving on handles
- Four backset sizes
- Two strike options
- Non-handed
- UL listed for all single labeled metal or wood doors

Dimensions

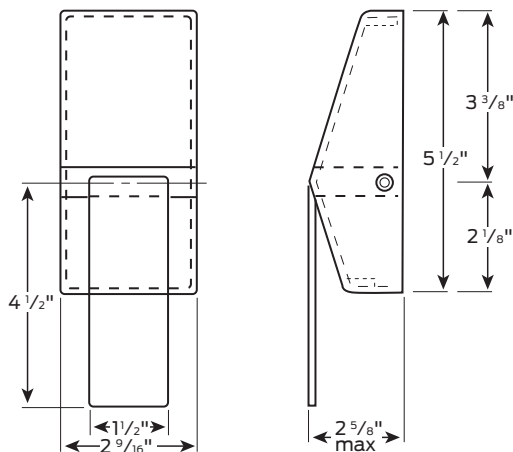

Functions

Schlage ANSI

HL6 -

Passage lock

- Latchbolt retracted by paddle from either side
- Inside paddle always free for immediate egress



Privacy push/pull hardware

PL7/PL8

Tubular push/pull hardware

This patented design is ideal for restrooms or patient bathrooms. It combines all the features and functions of the HL6 push/pull hardware with the added feature of a privacy mode actuated by a thumbturn. An opposite side release provides access in case of emergency.

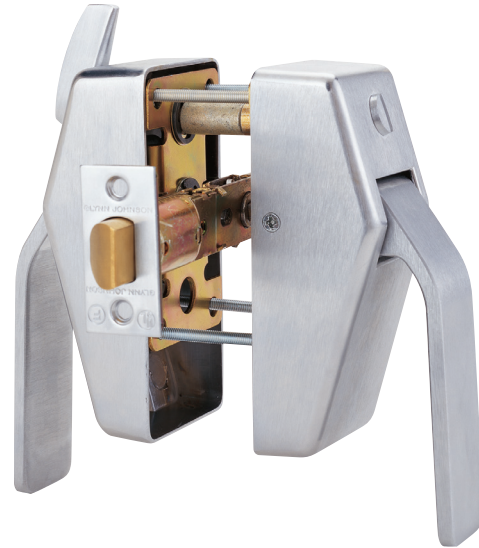

Features and benefits

- Quiet functionality
- Privacy function – pull or push side thumbturn
- Three mounting positions
- 10 finishes, including antimicrobial options
- Four available options, including engraving on handles
- Four backset sizes
- Two strike options
- Non-handed
- UL listed for all single labeled metal or wood doors

Dimensions

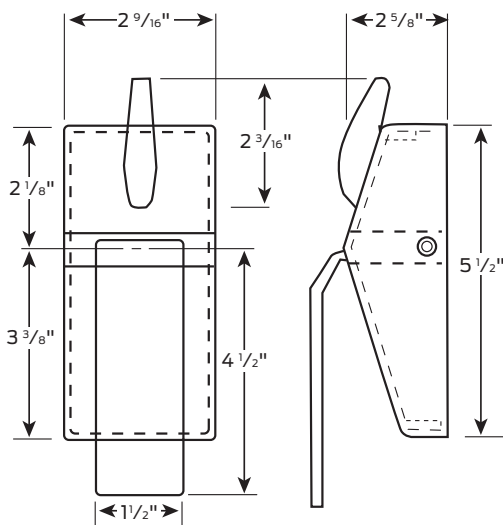

Functions

Schlage ANSI

PL7 —

Privacy, push-side thumbturn

- Latchbolt retracted by paddle from either side unless outside locked by push side thumbturn
- Actuating inside paddle, rotating inside thumbturn or outside coin turn unlocks door
- Inside paddle always free for immediate egress



PL8 —

Privacy, pull-side thumbturn

- Latchbolt retracted by paddle from either side unless outside locked by pull side thumbturn
- Actuating inside paddle, rotating inside thumbturn or outside coin turn unlocks door
- Inside paddle always free for immediate egress



Mortise push/pull hardware

HL6 Mortise

Mortise push/pull hardware

The HL6 with mortise hardware combines the features and convenience of the HL6 push/pull operation with the Schlage L Series heavy-duty mortise lock. The added functionality is particularly useful in areas where locking or electrified access is required.



Features and benefits

- Quiet functionality
- 16 mortise functions, including electrified and thumbturn options
- Five mounting positions
- 10 finishes, including antimicrobial options
- Seven available options, including request-to-exit and engraving on handles
- Two strike options
- Non-handed
- UL Listed for all single labeled metal or wood doors

Dimensions

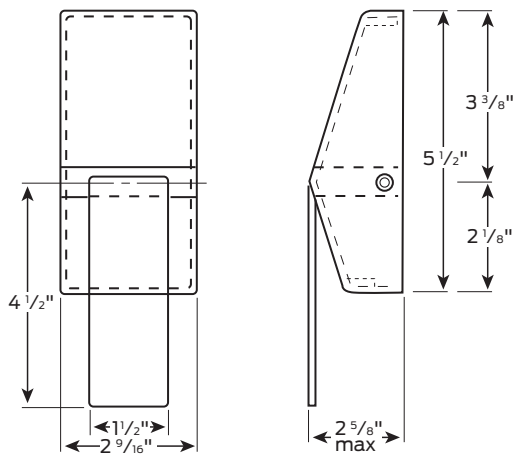

HL6 Mortise exit trim

Using the Von Duprin 9875/9975 mortise exit device, along with Schlage HL6 push/pull trim, Allegion has created an exit device with mortise lock durability and ADA compliance. Consult the Von Duprin 98/99 catalog for complete product information.

Functions legend

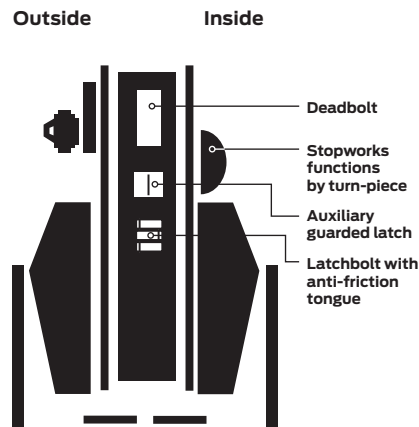



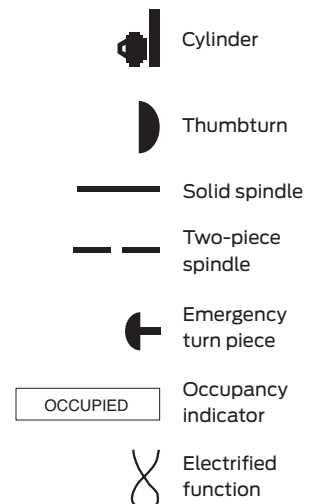





Functions key











Mortise hardware functions

HL6 mortise

Schlage HL6-9010 Passage lock <ul style="list-style-type: none"> • Latchbolt retracted by paddle from either side at all times • Inside paddle always free for immediate egress 	ANSI F01	Schlage HL6-9040 Bath/bedroom privacy lock <ul style="list-style-type: none"> • Latchbolt retracted by paddle from either side unless outside lever is locked by inside thumbturn • Actuating inside paddle or closing door unlocks outside paddle • To unlock from outside remove emergency button, insert emergency thumbturn (furnished) in access hole and rotate • Inside paddle always free for immediate egress 	ANSI F22	Schlage HL6-9050 Entrance/office lock <ul style="list-style-type: none"> • Latchbolt retracted by paddle from either side unless outside paddle is made inoperative by key or thumbturn • With outside locked, latchbolt retracted by key or inside paddle • Outside paddle locked until unlocked by thumbturn or key • Auxiliary latch deadlocks latchbolt when door is closed • Inside paddle always free for immediate egress 	ANSI F04	Schlage HL6-9060 Apartment entrance lock <ul style="list-style-type: none"> • Latchbolt retracted by paddle from either side unless outside is locked by key from inside • When locked, latchbolt retracted by key or inside paddle • Auxiliary latch deadlocks latchbolt when door is closed • Inside paddle always free for immediate egress 	ANSI F09
Schlage HL6-9070 Classroom lock <ul style="list-style-type: none"> • Latchbolt retracted by paddle from either side unless outside paddle is locked by key • Unlocked from outside by key • Auxiliary latch deadlocks latchbolt when door is closed • Inside paddle always free for immediate egress 	ANSI F05	Schlage HL6-9080 Storeroom lock <ul style="list-style-type: none"> • Latchbolt retracted by paddle inside or key outside • Outside paddle always inoperative • Auxiliary latch deadlocks latchbolt when door is closed • Inside paddle always free for immediate egress 	ANSI F07	Schlage HL6-9082 Institution lock <ul style="list-style-type: none"> • Latchbolt retracted by key from either side • Paddle on both sides always inoperative • Auxiliary latch deadlocks latchbolt when door is closed 	ANSI F30	Schlage HL6-9092EL HL6-9092EU Electrically locking/unlocking outside paddle, outside cylinder (replaces HL6-9080EL/EU) <ul style="list-style-type: none"> • Outside paddle continuously locked (EL) or unlocked (EU) by 12V or 24V DC • Latchbolt retracted by paddle inside or key outside • Auxiliary latch deadlocks latchbolt when door is closed • Inside paddle always free for immediate egress • EL: Switch or power failure allows outside lever to retract latchbolt • EU: Switch or power failure locks (EU) outside lever 	ANSI —

Mortise hardware functions

HL6 mortise

Schlage	ANSI	Schlage	ANSI	Schlage	ANSI	Schlage	ANSI
HL6-9095EL HL6-9095EU Electrically locked or electrically unlocked both sides, inside and outside cylinder <ul style="list-style-type: none"> Both paddles continuously locked (EL) or unlocked (EU) by 12V or 24V DC Latchbolt retracted by either key Auxiliary latch deadlocks latchbolt when door is closed EL: Switch or power failure unlocks both paddles and allows paddle to retract latchbolt EU: Switch or power failure locks both paddles 	—	HL6-9453 F20 Entrance/office lock with deadbolt <ul style="list-style-type: none"> Latchbolt retracted by paddle from either side unless outside locked by 20° thumbturn rotation Deadbolt actuation through 90° thumbturn rotation When locked, outside key or inside paddle retracts both deadbolt and latchbolt Outside paddle locked until thumbturn is restored to vertical position Throwing deadbolt locks outside paddle Auxiliary latch deadlocks latchbolt when door is closed Inside paddle always free for immediate egress 	F20	HL6-9456 F13 Corridor lock <ul style="list-style-type: none"> Latchbolt retracted by paddle from either side Deadbolt actuation by key or thumbturn rotation Throwing deadbolt locks outside paddle Actuating inside paddle retracts both deadbolt and latchbolt and unlocks outside paddle Inside paddle always free for immediate egress 	F13	HL6-9465 — Closet/storeroom lock <ul style="list-style-type: none"> Latchbolt retracted by paddle from either side Deadbolt actuation by key 	—
HL6-9466 F14 Store/utility room lock with deadbolt <ul style="list-style-type: none"> Latchbolt retracted by paddle from either side Deadbolt actuated by either key 	F14	HL6-9473 F21 Dormitory/bedroom lock <ul style="list-style-type: none"> Latchbolt retracted by paddle from either side Deadbolt actuation by outside key or inside thumbturn 	F21	HL6-9485 — Faculty/hotel/restroom lock <ul style="list-style-type: none"> Latchbolt retracted by outside key or inside paddle Outside paddle always fixed Deadbolt actuation by thumbturn All keys (except emergency and display keys) inoperative when deadbolt is thrown Inside paddle retracts both deadbolt and latchbolt Auxiliary latch deadlocks latchbolt when door is closed Inside lever always free for immediate egress 	—	HL6-9486 — Faculty/hotel/restroom lock with legacy indicator <ul style="list-style-type: none"> Adds 09-611 "DO NOT DISTURB" indicator to HL6-9485 Specify L583-375 for "OCCUPIED" When deadbolt is thrown indicator message is displayed and all keys (except emergency and display keys) become inoperative 	—

HL Series ordering instructions

To order Schlage products, descriptive data should be in the same sequence as shown:

Line item	Qty	Product/Function/Backset	Finish	Option	Engraving	Strike
1	2	3	4	5	6	7

Detail

1 Line item number

2 Quantity

3 Product/Function/Backset

Tubular: HL6 (passage), PL7 (privacy, thumbturn on push side), PL8 (privacy, thumbturn on pull side)
 Tubular backset: -2 (2 3/4" backset), -3 (3 3/4" backset), -5 (5" backset), -7 (7" backset)
 Mortise: HL6-xxxx (see pages 7-8)
 Mortise backset: Leave blank (always 2 3/4")

4 Finish

605	Bright brass (US3)	626	Satin chrome (US26D)
606	Satin brass (US4)	626AM	Satin chrome antimicrobial
612	Satin bronze (US10)	629	Bright stainless steel (US32)
613	Oil rubbed bronze (US10B)	630	Satin stainless steel (US32D)
625	Bright chrome (US26)	630AM	Satin stainless steel antimicrobial

5 Options (see product pages for availability)

B	Brass base material (for 626)	L	Lead lining
EN	Entrance Only (pull side)	RX	Request to Exit
EO	Exit Only (push side)	SOC	Pin-in-Socket security screws

6 Engraving option

E1, E2, E3, E4, E5, or E6 - Engraved handles (see page 11 for details)

9 Strike

Tubular: Leave blank for standard strike, A for ASA strike, AS for both standard and ASA strike
 Mortise: Leave blank for standard strike, specify BT for bent-tab strike

Example

Product	Line item	Qty	Product/Function/Backset	Finish	Option	Engraving	Strike
Tubular	1	5	HL6-5	626	BL	E6	A
Mortise	2	10	HL6-9070	626AM	SOC	E1	BT

Specifications and options

	HL6	PL7/PL8	HL mortise
Type	Tubular (bored)	Tubular (bored)	Mortise
Finishes	605 (US3), 606 (US4), 612 (US10), 613 (US10B), 625 (US26), 626/626AM (US26D), 629 (US32), 630/630AM (US32D)		
Mounting positions	Handles down Handles up One handle up, one handle down (push or pull) Handles point away from latch Handles point toward latch	Handles down Handles up Handles point towards latch	Handles down Handles up One handle up, one handle down (push or pull) Handles point away from latch
Thumbturn operation	—	Standard thumbturn or coin turn	Thumbturn available
Backset	Standard: 2 3/4" Optional: 3 3/4", 5", 7"	Standard: 2 3/4" Optional: 3 3/4", 5", 7"	2 3/4" only
Strike	Standard: 2 3/4" Optional ASA: 4 7/8" (A)	Standard: 2 3/4" Optional ASA: 4 7/8" (A)	Standard: ASA Strike Optional: Bent Tab (BT)
Options	B, E, EN, EO, L, SOC	B, E, L, SOC	B, E, EN, EO, L, RX, SOC
Handing	Non-handed		
Door thickness	1 3/4" only (other thicknesses upon request)		
Functions	Passage	Privacy, pull-side thumbturn Privacy, push-side thumbturn	16, including electrified and thumbturn options
Engraving	Optional engraving of PUSH or PULL, see page 11 for engraving guide		
Latchbolt	1/2" throw stainless steel	1/2" throw stainless steel	3/4" throw stainless steel
Certifications	UL Listed for 3-hour fire door, 4' x 8'	UL Listed for 3-hour fire door, 4' x 8'	UL Listed for 3-hour fire door, 4' x 10'

*Option suffixes: B - Brass Base Material, E - Engraved Handles, EN - Entrance Only, EO - Exit Only, L - Lead Lining, RX - Request to Exit and SOC - Pin-in-Socket Security Screws.

Options definitions

B - Brass base material

Designates use of brass base material with 626 finish (if required per specification).

E - Engraved handles

Adds "push" and "pull" engraving to the handles, see page 11 for engraving guide.

EN – Entrance only

Pull handle only for doors where only one side is used for entry and no exit is required.

EO - Exit only

Push handle only for doors where only one side is used for exit and where the security of no entry is required.

L - Lead lining

Provides lead components to cover cut-outs made in lead lined doors.







RX - Request to Exit function

Option for electrified only. Monitors the inside paddle to balance security with lever actuation sensitivity.









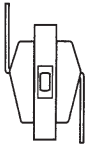
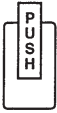

SOC - Pin-in-socket security screws

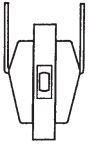
Pin-in-socket screws are provided instead of standard screws for the strike, latchbolt and covers.

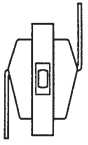
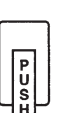
Finish options

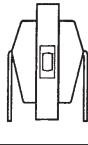
								
Color	Bright brass	Satin brass	Satin bronze	Oil rubbed bronze	Bright chrome	Satin chrome	Bright stainless steel	Satin stainless steel
ANSI/BHMA number	605	606	612	613	625	626/626AM	629	630/630AM
US number	US3	US4	US10	US10B	US26	US26D	US32	US32D

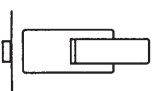
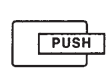
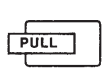
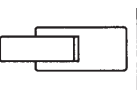
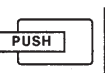
Engraving options

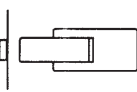
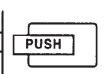
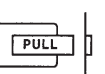
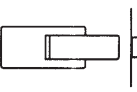
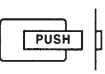
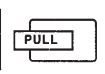
		Mounting position	Availability	To order, specify
	 	Push up, pull down <ul style="list-style-type: none"> Any backset Non-handed 	<ul style="list-style-type: none"> Passage HL6 Mortise HL6 	E1
	 	Push up, pull up <ul style="list-style-type: none"> Any backset Non-handed 	<ul style="list-style-type: none"> Passage HL6 Mortise HL6 Privacy PL7/PL8 	E2
	 	Push down, pull up <ul style="list-style-type: none"> Any backset Non-handed 	<ul style="list-style-type: none"> Passage HL6 Mortise HL6 	E5
	 	Push down, pull down <ul style="list-style-type: none"> Any backset Non-handed 	<ul style="list-style-type: none"> Passage HL6 Mortise HL6 Privacy PL7/PL8 	E6
	 	Horizontal engraving <ul style="list-style-type: none"> Any backset RH 	<ul style="list-style-type: none"> Passage HL6 Mortise HL6 	E3
	 	Horizontal engraving <ul style="list-style-type: none"> Any backset LH 	<ul style="list-style-type: none"> Passage HL6 Mortise HL6 	E4
	 	Horizontal engraving <ul style="list-style-type: none"> 7" backset only RH 	<ul style="list-style-type: none"> Passage HL6 	E4
	 	Horizontal engraving <ul style="list-style-type: none"> 7" backset only LH 	<ul style="list-style-type: none"> Passage HL6 	E3

About Allegion

Allegion (NYSE: ALLE) is a global pioneer in safety and security, with leading brands like CISA®, Interflex®, LCN®, Schlage®, SimonsVoss® and Von Duprin®. Focusing on security around the door and adjacent areas, Allegion produces a range of solutions for homes, businesses, schools and other institutions. Allegion is a \$2 billion company, with products sold in almost 130 countries.

For more, visit www.allegion.com

KRYPTONITE ■ LCN ■  ■ STEELCRAFT ■ VON DUPRIN